

Datový list | Objednací číslo: 280-626

Dvojitá průchozí svorka; 2,5 mm²; Boční držáky značení; Na DIN lištu 35 × 15 a 35 × 7,5; CAGE CLAMP®; 2,50 mm²; Šedá

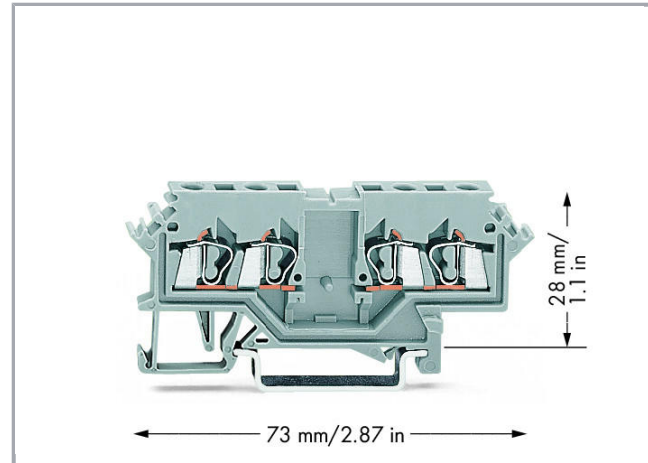

www.wago.com/280-626

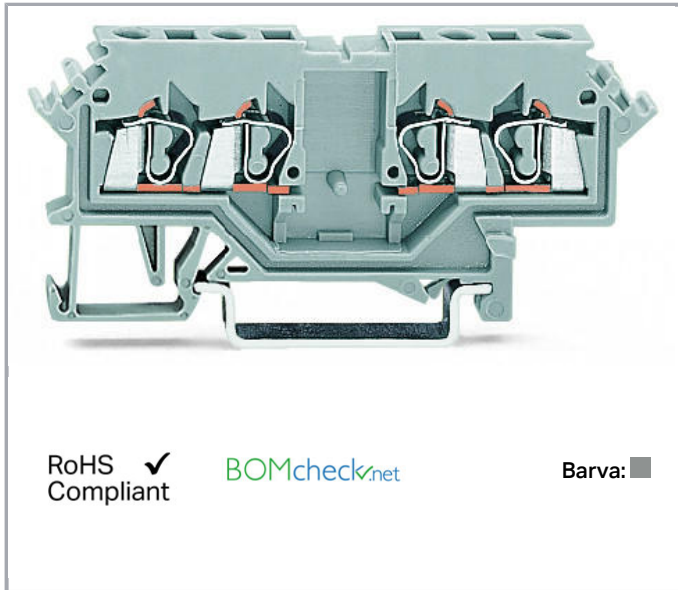

Popis položky

Upozornění:

Terminating Aluminum Conductors

WAGO spring clamp terminal blocks are suitable for solid aluminum conductors up to 4 mm²/12 AWG if WAGO "Alu-Plus" Contact Paste is used for termination.

"Alu-Plus" Contact Paste Advantages:

- Automatically destroys the oxide film during clamping.
- Prevents fresh oxidation at the clamping point.
- Prevents electrolytic corrosion between aluminum and copper conductors (in the same terminal block).
- Provides long-term protection against corrosion.

Using terminal blocks with CAGE CLAMP® Spring Pressure Connection Technology, **aluminum conductors must first be cleaned with a blade** and then immediately be inserted into the clamping units filled with "Alu-Plus" Contact Paste.

It is also possible to apply WAGO "Alu-Plus" **additionally** on the whole surface of the aluminum conductor before termination.

Please note that the nominal currents must be adapted to the reduced conductivity of the aluminum conductors:

2.5 mm² (14 AWG) = 16 A

4 mm² (12 AWG) = 22 A

Bezpečnostní upozornění 1:

Pozor: Tuto dvojitou průchozí svorku nelze propojit příčnými můstky!

**Data****Elektrické parametry****Ratings per IEC/EN 60664-1**

Návrhové napětí (III / 3)	800 V
Návrhové rázové napětí (III / 3)	8 kV
Jmenovitý proud	24 A
Legenda (návrhové hodnoty)	(III / 3) Δ kategorie přepětí III / stupeň znečištění 3

Údaje o připojení

Připojovací technika	CAGE CLAMP®
Způsob ovládání	Ovládací nástroj
Materiály přípojitelých vodičů	Měď Hliník
Plný vodič	0,08 ... 2,5 mm ² / 28 ... 12 AWG
Jemně laněný vodič	0,08 ... 2,5 mm ² / 28 ... 12 AWG
Délka odizolování	8 ... 9 mm / 0.31 ... 0.35 palec
Celkový počet kontaktních míst	4
Celkový počet potenciálů	2
Počet úrovní	1
Způsob zapojení	čelní připojení
Upozornění (průřez vodiče)	12 AWG: THHN, THWN

Geometrické údaje

Šířka	5 mm / 0.197 inch
Výška od horní hrany lišty DIN 35	28 mm / 1.102 inch
Hloubka	73 mm / 2.874 inch

Mechanické parametry

Provedení	Horizontální provedení
Způsob montáže	Lišta DIN 35
Úroveň popisování	Boční popis

Údaje o materiálu



barva	Šedá
Izolační materiál	Polyamid 66 (PA 66)
Požární zatížení	0.142 MJ
Hmotnost	8.187 g

Obchodní údaje

Product Group	1 (Rail Mounted Terminal Blocks)
Druh balení	BOX
Country of origin	DE
GTIN	4044918395687
Customs Tariff No.	85369010000

Atesty/certifikáty

Specifické atesty jednotlivých států

Logo	Schválení	Doplňkový text schválení	Název certifikátu
	CCA DEKRA Certification B.V.	EN 60947	2157201.01
	CSA DEKRA Certification B.V.	C22.2	1536071

Atesty pro použití v loďním průmyslu

Logo	Schválení	Doplňkový text schválení	Název certifikátu
	ABS American Bureau of Shipping	EN 60947	14- HG1293677- PDA
	BV Bureau Veritas S.A.	EN 60947	07436/E0 BV
	DNV GL Det Norske Veritas, Germanischer Lloyd	-	TAE00001V2
	LR Lloyds Register	EN 60947	91/20112 (E9)

Atesty UL

Logo	Schválení	Doplňkový text schválení	Název certifikátu
	UR Underwriters Laboratories Inc.	UL 1059	E45172























Kompatibilní produkty













End plate

	Obj. č.: 280-316 Koncová bočnice a separátor; Tloušťka 2,5 mm; Šedá	www.wago.com/280-316
	Obj. č.: 280-317 Koncová bočnice a separátor; Tloušťka 2,5 mm; Oranžová	www.wago.com/280-317
	Obj. č.: 280-327 Přepážka; Tloušťka 2 mm; S přesahem; Oranžová	www.wago.com/280-327
	Obj. č.: 280-337 Přepážka; Tloušťka 2 mm; S přesahem; Šedá	www.wago.com/280-337



General accessories

	Obj. č.: 231-162/003-000 Male connector for rail-mount terminal blocks; 1.2 x 1.2 mm pins; Rovné provedení; Rozteč 5 mm; 2pól.; Šedá	www.wago.com/231-162/003-000
	Obj. č.: 231-163/003-000 Male connector for rail-mount terminal blocks; 1.2 x 1.2 mm pins; Rovné provedení; Rozteč 5 mm; 3pól.; Šedá	www.wago.com/231-163/003-000
	Obj. č.: 231-164/003-000 Male connector for rail-mount terminal blocks; 1.2 x 1.2 mm pins; Rovné provedení; Rozteč 5 mm; 4pól.; Šedá	www.wago.com/231-164/003-000
	Obj. č.: 231-165/003-000 Male connector for rail-mount terminal blocks; 1.2 x 1.2 mm pins; Rovné provedení; Rozteč 5 mm; 5pól.; Šedá	www.wago.com/231-165/003-000
	Obj. č.: 231-166/003-000 Male connector for rail-mount terminal blocks; 1.2 x 1.2 mm pins; Rovné provedení; Rozteč 5 mm; 6pól.; Šedá	www.wago.com/231-166/003-000
	Obj. č.: 231-167/003-000 Male connector for rail-mount terminal blocks; 1.2 x 1.2 mm pins; Rovné provedení; Rozteč 5 mm;	

	7pól.; Šedá	www.wago.com/231-167/003-000
	Obj. č.: 231-168/003-000 Male connector for rail-mount terminal blocks; 1.2 x 1.2 mm pins; Rovné provedení; Rozteč 5 mm; 8pól.; Šedá	www.wago.com/231-168/003-000
	Obj. č.: 231-169/003-000 Male connector for rail-mount terminal blocks; 1.2 x 1.2 mm pins; Rovné provedení; Rozteč 5 mm; 9pól.; Šedá	www.wago.com/231-169/003-000
	Obj. č.: 231-170/003-000 Male connector for rail-mount terminal blocks; 1.2 x 1.2 mm pins; Rovné provedení; Rozteč 5 mm; 10pól.; Šedá	www.wago.com/231-170/003-000
	Obj. č.: 231-171/003-000 Male connector for rail-mount terminal blocks; 1.2 x 1.2 mm pins; Rovné provedení; Rozteč 5 mm; 11pól.; Šedá	www.wago.com/231-171/003-000
	Obj. č.: 231-172/003-000 Male connector for rail-mount terminal blocks; 1.2 x 1.2 mm pins; Rovné provedení; Rozteč 5 mm; 12pól.; Šedá	www.wago.com/231-172/003-000
	Obj. č.: 231-176/003-000 Male connector for rail-mount terminal blocks; 1.2 x 1.2 mm pins; Rovné provedení; Rozteč 5 mm; 16pól.; Šedá	www.wago.com/231-176/003-000
	Obj. č.: 231-180/003-000 Male connector for rail-mount terminal blocks; 1.2 x 1.2 mm pins; Rovné provedení; Rozteč 5 mm; 20pól.; Šedá	www.wago.com/231-180/003-000
	Obj. č.: 231-668 Zavírací kolíky; K uzavření nepotřebných kontaktních míst; Šedá	www.wago.com/231-668
	Obj. č.: 231-669 Zavírací kolíky; K uzavření nepotřebných kontaktních míst; Oranžová	www.wago.com/231-669
	Obj. č.: 249-105 Nosič skupinového označení	www.wago.com/249-105
	Obj. č.: 721-162/003-000 Male connector for rail-mount terminal blocks; 1.2 x 1.2 mm pins; Rovné provedení; 100% ochrana proti chybnému zapojení; Rozteč 5 mm; 2pól.; Světle šedá	www.wago.com/721-162/003-000
	Obj. č.: 721-163/003-000 Male connector for rail-mount terminal blocks; 1.2 x 1.2 mm pins; Rovné provedení; 100% ochrana proti chybnému zapojení; Rozteč 5 mm; 3pól.; Světle šedá	www.wago.com/721-163/003-000
	Obj. č.: 721-164/003-000 Male connector for rail-mount terminal blocks; 1.2 x 1.2 mm pins; straight; 100% protected against mismatching; Pin spacing 5 mm; 4-pole; light gray	www.wago.com/721-164/003-000
	Obj. č.: 721-165/003-000 Male connector for rail-mount terminal blocks; 1.2 x 1.2 mm pins; Rovné provedení; 100% ochrana proti chybnému zapojení; Rozteč 5 mm; 5pól.; Světle šedá	www.wago.com/721-165/003-000











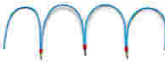





	Obj. č.: 721-166/003-000 Male connector for rail-mount terminal blocks; 1.2 x 1.2 mm pins; Rovné provedení; 100% ochrana proti chybnému zapojení; Rozteč 5 mm; 6pól.; Světle šedá	www.wago.com/721-166/003-000
	Obj. č.: 721-167/003-000 Male connector for rail-mount terminal blocks; 1.2 x 1.2 mm pins; Rovné provedení; 100% ochrana proti chybnému zapojení; Rozteč 5 mm; 7pól.; Světle šedá	www.wago.com/721-167/003-000
	Obj. č.: 721-168/003-000 Male connector for rail-mount terminal blocks; 1.2 x 1.2 mm pins; Rovné provedení; 100% ochrana proti chybnému zapojení; Rozteč 5 mm; 8pól.; Světle šedá	www.wago.com/721-168/003-000
	Obj. č.: 721-169/003-000 Male connector for rail-mount terminal blocks; 1.2 x 1.2 mm pins; Rovné provedení; 100% ochrana proti chybnému zapojení; Rozteč 5 mm; 9pól.; Světle šedá	www.wago.com/721-169/003-000
	Obj. č.: 721-170/003-000 Male connector for rail-mount terminal blocks; 1.2 x 1.2 mm pins; Rovné provedení; 100% ochrana proti chybnému zapojení; Rozteč 5 mm; 10pól.; Světle šedá	www.wago.com/721-170/003-000
	Obj. č.: 721-171/003-000 Male connector for rail-mount terminal blocks; 1.2 x 1.2 mm pins; straight; 100% protected against mismatching; Pin spacing 5 mm; 11-pole; light gray	www.wago.com/721-171/003-000
	Obj. č.: 721-172/003-000 Male connector for rail-mount terminal blocks; 1.2 x 1.2 mm pins; Rovné provedení; 100% ochrana proti chybnému zapojení; Rozteč 5 mm; 12pól.; Světle šedá	www.wago.com/721-172/003-000
	Obj. č.: 721-173/003-000 Male connector for rail-mount terminal blocks; 1.2 x 1.2 mm pins; straight; 100% protected against mismatching; Pin spacing 5 mm; 13-pole; light gray	www.wago.com/721-173/003-000
	Obj. č.: 721-174/003-000 Male connector for rail-mount terminal blocks; 1.2 x 1.2 mm pins; straight; 100% protected against mismatching; Pin spacing 5 mm; 14-pole; light gray	www.wago.com/721-174/003-000
	Obj. č.: 721-175/003-000 Male connector for rail-mount terminal blocks; 1.2 x 1.2 mm pins; straight; 100% protected against mismatching; Pin spacing 5 mm; 15-pole; light gray	www.wago.com/721-175/003-000
	Obj. č.: 721-176/003-000 Male connector for rail-mount terminal blocks; 1.2 x 1.2 mm pins; Rovné provedení; 100% ochrana proti chybnému zapojení; Rozteč 5 mm; 16pól.; Světle šedá	www.wago.com/721-176/003-000
	Obj. č.: 721-180/003-000 Male connector for rail-mount terminal blocks; 1.2 x 1.2 mm pins; straight; 100% protected against mismatching; Pin spacing 5 mm; 20-pole; light gray	www.wago.com/721-180/003-000















assembling

	Obj. č.: 209-106 Držák; K izolované montáži nosných lišt DIN 35; Šedá	www.wago.com/209-106
	Obj. č.: 709-153 Krycí profil; Typ 1; Vhodný pro držák krycího profilu typu 1; Délka 1 m; Transparentní	www.wago.com/709-153

Jumper

	Obj. č.: 210-103 Vícenásobný vodičový můstek; Izolováno; 50 přípojek; Černá	www.wago.com/210-103
------------------------------------------------------------------------------------	---------------------------------------------------------------------------------------	----------------------------------------------------------------

	Obj. č.: 210-123 Vícenásobný vodičový můstek; Izolováno; 50 přípojek	www.wago.com/210-123
	Obj. č.: 280-482 Hřebenový můstek; Izolováno; 2x; IN = IN svorky; Šedá	www.wago.com/280-482
	Obj. č.: 280-483 Hřebenový můstek; Izolováno; 3x; IN = IN svorky; Šedá	www.wago.com/280-483
	Obj. č.: 280-484 Hřebenový můstek; Izolováno; 4x; IN = IN svorky; Šedá	www.wago.com/280-484
	Obj. č.: 280-485 Hřebenový můstek; Izolováno; 5x; IN = IN svorky; Šedá	www.wago.com/280-485
	Obj. č.: 280-490 Hřebenový můstek; Izolováno; 10x; IN = IN svorky; Šedá	www.wago.com/280-490
	Obj. č.: 280-492 Hřebenový můstek ob svorku; Izolováno; 2x; IN = IN svorky; Šedá	www.wago.com/280-492
	Obj. č.: 709-110 Vícenásobný vodičový můstek; Izolováno; 4 přípojky; 3 × 110 mm; Černá	www.wago.com/709-110
	Obj. č.: 709-111 Vícenásobný vodičový můstek; Izolováno; 3 přípojek; 2 × 120 mm; Černá	www.wago.com/709-111
	Obj. č.: 709-112 Vícenásobný vodičový můstek; Izolováno; 3 přípojek; 2 × 170 mm; Černá	www.wago.com/709-112
tools		
	Obj. č.: 210-657 Ovládací nástroj; Břit: 3,5 × 0,5 mm; S částečně izolovanou rukojetí; Krátké	www.wago.com/210-657
	Obj. č.: 210-658 Ovládací nástroj; Břit: 3,5 × 0,5 mm; S částečně izolovanou rukojetí; Úhlové provedení; Krátké	www.wago.com/210-658
	Obj. č.: 210-720 Ovládací nástroj; Břit: 3,5 × 0,5 mm; S částečně izolovanou rukojetí	www.wago.com/210-720
Female plug		
	Obj. č.: 232-132/005-000 Female connector for rail-mount terminal blocks; Rovné provedení; Rozteč 5 mm; 2pól.; Šedá	www.wago.com/232-132/005-000
	Obj. č.: 232-132/005-000/039-000 Female connector for rail-mount terminal blocks; straight; Locking lever; Pin spacing 5 mm; 3-pole; gray	www.wago.com/232-132/005-000/039-000
	Obj. č.: 232-133/005-000 Female connector for rail-mount terminal blocks; Rovné provedení; Rozteč 5 mm; 3pól.; Šedá	www.wago.com/232-133/005-000
	Obj. č.: 232-133/005-000/039-000 Female connector for rail-mount terminal blocks; Rovné provedení; Blokovácí západka; Rozteč 5 mm; 3pól.; Šedá	www.wago.com/232-133/005-000/039-000

	Obj. č.: 232-134/005-000 Female connector for rail-mount terminal blocks; Rovné provedení; Rozteč 5 mm; 4pól.; Šedá	www.wago.com/232-134/005-000
	Obj. č.: 232-134/005-000/039-000 Female connector for rail-mount terminal blocks; Rovné provedení; Blokovací západka; Rozteč 5 mm; 4pól.; Šedá	www.wago.com/232-134/005-000/039-000
	Obj. č.: 232-135/005-000 Female connector for rail-mount terminal blocks; Rovné provedení; Rozteč 5 mm; 5pól.; Šedá	www.wago.com/232-135/005-000
	Obj. č.: 232-135/005-000/039-000 Female connector for rail-mount terminal blocks; Rovné provedení; Blokovací západka; Rozteč 5 mm; 5pól.; Šedá	www.wago.com/232-135/005-000/039-000
	Obj. č.: 232-136/005-000 Female connector for rail-mount terminal blocks; Rovné provedení; Rozteč 5 mm; 6pól.; Šedá	www.wago.com/232-136/005-000
	Obj. č.: 232-136/005-000/039-000 Female connector for rail-mount terminal blocks; Rovné provedení; Blokovací západka; Rozteč 5 mm; 6pól.; Šedá	www.wago.com/232-136/005-000/039-000
	Obj. č.: 232-137/005-000 Female connector for rail-mount terminal blocks; Rovné provedení; Rozteč 5 mm; 7pól.; Šedá	www.wago.com/232-137/005-000
	Obj. č.: 232-137/005-000/039-000 Female connector for rail-mount terminal blocks; Rovné provedení; Blokovací západka; Rozteč 5 mm; 7pól.; Šedá	www.wago.com/232-137/005-000/039-000
	Obj. č.: 232-138/005-000 Female connector for rail-mount terminal blocks; Rovné provedení; Rozteč 5 mm; 8pól.; Šedá	www.wago.com/232-138/005-000
	Obj. č.: 232-138/005-000/039-000 Female connector for rail-mount terminal blocks; Rovné provedení; Blokovací západka; Rozteč 5 mm; 8pól.; Šedá	www.wago.com/232-138/005-000/039-000
	Obj. č.: 232-139/005-000 Female connector for rail-mount terminal blocks; Rovné provedení; Rozteč 5 mm; 9pól.; Šedá	www.wago.com/232-139/005-000
	Obj. č.: 232-139/005-000/039-000 Female connector for rail-mount terminal blocks; Rovné provedení; Blokovací západka; Rozteč 5 mm; 9pól.; Šedá	www.wago.com/232-139/005-000/039-000
	Obj. č.: 232-140/005-000 Female connector for rail-mount terminal blocks; Rovné provedení; Rozteč 5 mm; 10pól.; Šedá	www.wago.com/232-140/005-000
	Obj. č.: 232-140/005-000/039-000 Female connector for rail-mount terminal blocks; Rovné provedení; Blokovací západka; Rozteč 5 mm; 10pól.; Šedá	www.wago.com/232-140/005-000/039-000
	Obj. č.: 232-142/005-000 Female connector for rail-mount terminal blocks; Rovné provedení; Rozteč 5 mm; 12pól.; Šedá	www.wago.com/232-142/005-000

**Obj. č.: 232-142/005-000/039-000**

Female connector for rail-mount terminal blocks; Rovné provedení; Blokovací západka; Rozteč 5 mm; 12pól.; Šedá

www.wago.com/232-142/005-000/039-000**Obj. č.: 232-146/005-000**

Female connector for rail-mount terminal blocks; Rovné provedení; Rozteč 5 mm; 16pól.; Šedá

www.wago.com/232-146/005-000**Obj. č.: 232-146/005-000/039-000**

Female connector for rail-mount terminal blocks; Rovné provedení; Blokovací západka; Rozteč 5 mm; 16pól.; Šedá

www.wago.com/232-146/005-000/039-000**Obj. č.: 232-147/005-000/039-000**

Female connector for rail-mount terminal blocks; straight; Locking lever; Pin spacing 5 mm; 17-pole; gray

www.wago.com/232-147/005-000/039-000**Obj. č.: 232-150/005-000**

Female connector for rail-mount terminal blocks; Rovné provedení; Rozteč 5 mm; 20pól.; Šedá

www.wago.com/232-150/005-000**Obj. č.: 232-150/005-000/039-000**

Female connector for rail-mount terminal blocks; straight; Locking lever; Pin spacing 5 mm; 20-pole; gray

www.wago.com/232-150/005-000/039-000**Obj. č.: 232-232/005-000**

Female connector for rail-mount terminal blocks; Úhlové provedení; Rozteč 5 mm; 2pól.; Šedá

www.wago.com/232-232/005-000**Obj. č.: 232-232/005-000/039-000**

Female connector for rail-mount terminal blocks; Úhlové provedení; Blokovací západka; Rozteč 5 mm; 2pól.; Šedá

www.wago.com/232-232/005-000/039-000**Obj. č.: 232-233/005-000**

Female connector for rail-mount terminal blocks; Úhlové provedení; Rozteč 5 mm; 3pól.; Šedá

www.wago.com/232-233/005-000**Obj. č.: 232-233/005-000/039-000**

Female connector for rail-mount terminal blocks; angled; Locking lever; Pin spacing 5 mm; 3-pole; gray

www.wago.com/232-233/005-000/039-000**Obj. č.: 232-234/005-000**

Female connector for rail-mount terminal blocks; Úhlové provedení; Rozteč 5 mm; 4pól.; Šedá

www.wago.com/232-234/005-000**Obj. č.: 232-234/005-000/039-000**

Female connector for rail-mount terminal blocks; Úhlové provedení; Blokovací západka; Rozteč 5 mm; 4pól.; Šedá















www.wago.com/232-234/005-000/039-000**Obj. č.: 232-235/005-000**















Female connector for rail-mount terminal blocks; Úhlové provedení; Rozteč 5 mm; 5pól.; Šedá















www.wago.com/232-235/005-000**Obj. č.: 232-235/005-000/039-000**















Female connector for rail-mount terminal blocks; Úhlové provedení; Blokovací západka; Rozteč 5 mm; 5pól.; Šedá

www.wago.com/232-235/005-000/039-000

	Obj. č.: 232-236/005-000 Female connector for rail-mount terminal blocks; Úhlové provedení; Rozteč 5 mm; 6pól.; Šedá	www.wago.com/232-236/005-000
	Obj. č.: 232-236/005-000/039-000 Female connector for rail-mount terminal blocks; angled; Locking lever; Pin spacing 5 mm; 6-pole; gray	www.wago.com/232-236/005-000/039-000
	Obj. č.: 232-237/005-000 Female connector for rail-mount terminal blocks; Úhlové provedení; Rozteč 5 mm; 7pól.; Šedá	www.wago.com/232-237/005-000
	Obj. č.: 232-238/005-000 Female connector for rail-mount terminal blocks; Úhlové provedení; Rozteč 5 mm; 8pól.; Šedá	www.wago.com/232-238/005-000
	Obj. č.: 232-239/005-000 Female connector for rail-mount terminal blocks; Úhlové provedení; Rozteč 5 mm; 9pól.; Šedá	www.wago.com/232-239/005-000
	Obj. č.: 232-240/005-000 Female connector for rail-mount terminal blocks; Úhlové provedení; Rozteč 5 mm; 10pól.; Šedá	www.wago.com/232-240/005-000
	Obj. č.: 232-240/005-000/039-000 Female connector for rail-mount terminal blocks; Úhlové provedení; Blokovací západka; Rozteč 5 mm; 10pól.; Šedá	www.wago.com/232-240/005-000/039-000
	Obj. č.: 232-242/005-000 Female connector for rail-mount terminal blocks; Úhlové provedení; Rozteč 5 mm; 12pól.; Šedá	www.wago.com/232-242/005-000
	Obj. č.: 232-242/005-000/039-000 Female connector for rail-mount terminal blocks; Úhlové provedení; Blokovací západka; Rozteč 5 mm; 12pól.; Šedá	www.wago.com/232-242/005-000/039-000
	Obj. č.: 232-246/005-000 Female connector for rail-mount terminal blocks; Úhlové provedení; Rozteč 5 mm; 16pól.; Šedá	www.wago.com/232-246/005-000
	Obj. č.: 232-246/005-000/039-000 Female connector for rail-mount terminal blocks; Úhlové provedení; Blokovací západka; Rozteč 5 mm; 16pól.; Šedá	www.wago.com/232-246/005-000/039-000
	Obj. č.: 232-250/005-000 Female connector for rail-mount terminal blocks; Úhlové provedení; Rozteč 5 mm; 20pól.; Šedá	www.wago.com/232-250/005-000
	Obj. č.: 232-250/005-000/039-000 Female connector for rail-mount terminal blocks; angled; Locking lever; Pin spacing 5 mm; 20-pole; gray	www.wago.com/232-250/005-000/039-000
	Obj. č.: 232-732/005-000 Female connector for rail-mount terminal blocks; Rovné provedení; Rozteč 7,5 mm; 2pól.; Šedá	www.wago.com/232-732/005-000
	Obj. č.: 232-733/005-000 Female connector for rail-mount terminal blocks; Rovné provedení; Rozteč 7,5 mm; 3pól.; Šedá	www.wago.com/232-733/005-000

	Obj. č.: 232-734/005-000 Female connector for rail-mount terminal blocks; Rovné provedení; Rozteč 7,5 mm; 4pól.; Šedá	www.wago.com/232-734/005-000
	Obj. č.: 232-734/005-000/039-000 Female connector for rail-mount terminal blocks; Rovné provedení; Rozteč 7,5 mm; 4pól.; Šedá	www.wago.com/232-734/005-000/039-000
	Obj. č.: 232-735/005-000 Female connector for rail-mount terminal blocks; Rovné provedení; Rozteč 7,5 mm; 5pól.; Šedá	www.wago.com/232-735/005-000
	Obj. č.: 232-735/005-000/039-000 Female connector for rail-mount terminal blocks; Rovné provedení; Rozteč 7,5 mm; 5pól.; Šedá	www.wago.com/232-735/005-000/039-000
	Obj. č.: 232-736/005-000 Female connector for rail-mount terminal blocks; Rovné provedení; Rozteč 7,5 mm; 6pól.; Šedá	www.wago.com/232-736/005-000
	Obj. č.: 232-736/005-000/039-000 Female connector for rail-mount terminal blocks; Rovné provedení; Rozteč 7,5 mm; 6pól.; Šedá	www.wago.com/232-736/005-000/039-000
	Obj. č.: 232-738/005-000 Female connector for rail-mount terminal blocks; Rovné provedení; Rozteč 7,5 mm; 8pól.; Šedá	www.wago.com/232-738/005-000
	Obj. č.: 232-740/005-000 Female connector for rail-mount terminal blocks; Rovné provedení; Rozteč 7,5 mm; 10pól.; Šedá	www.wago.com/232-740/005-000
	Obj. č.: 232-742/005-000 Female connector for rail-mount terminal blocks; Rovné provedení; Rozteč 7,5 mm; 12pól.; Šedá	www.wago.com/232-742/005-000
	Obj. č.: 232-832/005-000 Pružinová svorkovnice THT; 0,6 x 1,0 mm solder pin; Úhlové provedení; Rozteč 7,5 mm; 2pól.; Šedá	www.wago.com/232-832/005-000
	Obj. č.: 232-833/005-000 Pružinová svorkovnice THT; 0,6 x 1,0 mm solder pin; Úhlové provedení; Rozteč 7,5 mm; 3pól.; Šedá	www.wago.com/232-833/005-000
	Obj. č.: 232-834/005-000 Pružinová svorkovnice THT; 0,6 x 1,0 mm solder pin; Úhlové provedení; Rozteč 7,5 mm; 4pól.; Šedá	www.wago.com/232-834/005-000
	Obj. č.: 232-836/005-000 Pružinová svorkovnice THT; 0,6 x 1,0 mm solder pin; Úhlové provedení; Rozteč 7,5 mm; 6pól.; Šedá	www.wago.com/232-836/005-000
	Obj. č.: 232-836/005-000/039-000 Pružinová svorkovnice THT; 0,6 x 1,0 mm solder pin; Úhlové provedení; Blokovací západka; Rozteč 7,5 mm; 6pól.; Šedá	www.wago.com/232-836/005-000/039-000

	Obj. č.: 232-840/005-000 Pružinová svorkovnice THT; 0,6 x 1,0 mm solder pin; Úhlové provedení; Rozteč 7,5 mm; 10pól.; Šedá	www.wago.com/232-840/005-000
	Obj. č.: 232-842/005-000 THT female header; 0,6 x 1,0 mm solder pin; angled; Pin spacing 7.5 mm; 12-pole; gray	www.wago.com/232-842/005-000
	Obj. č.: 722-132/005-000 Female connector for rail-mount terminal blocks; Rovné provedení; 100% ochrana proti chybnému zapojení; Rozteč 5 mm; 2pól.; Světle šedá	www.wago.com/722-132/005-000
	Obj. č.: 722-132/005-000/039-000 Female connector for rail-mount terminal blocks; Rovné provedení; 100% ochrana proti chybnému zapojení; Blokovací západka; Rozteč 5 mm; 3pól.; Světle šedá	www.wago.com/722-132/005-000/039-000
	Obj. č.: 722-133/005-000 Female connector for rail-mount terminal blocks; Rovné provedení; 100% ochrana proti chybnému zapojení; Rozteč 5 mm; 3pól.; Světle šedá	www.wago.com/722-133/005-000
	Obj. č.: 722-133/005-000/039-000 Female connector for rail-mount terminal blocks; Rovné provedení; 100% ochrana proti chybnému zapojení; Blokovací západka; Rozteč 5 mm; 3pól.; Světle šedá	www.wago.com/722-133/005-000/039-000
	Obj. č.: 722-134/005-000 Female connector for rail-mount terminal blocks; Rovné provedení; 100% ochrana proti chybnému zapojení; Rozteč 5 mm; 4pól.; Světle šedá	www.wago.com/722-134/005-000
	Obj. č.: 722-134/005-000/039-000 Female connector for rail-mount terminal blocks; Rovné provedení; 100% ochrana proti chybnému zapojení; Blokovací západka; Rozteč 5 mm; 4pól.; Světle šedá	www.wago.com/722-134/005-000/039-000
	Obj. č.: 722-135/005-000 Female connector for rail-mount terminal blocks; Rovné provedení; 100% ochrana proti chybnému zapojení; Rozteč 5 mm; 5pól.; Světle šedá	www.wago.com/722-135/005-000
	Obj. č.: 722-135/005-000/039-000 Female connector for rail-mount terminal blocks; Rovné provedení; 100% ochrana proti chybnému zapojení; Blokovací západka; Rozteč 5 mm; 5pól.; Světle šedá	www.wago.com/722-135/005-000/039-000
	Obj. č.: 722-136/005-000 Female connector for rail-mount terminal blocks; Rovné provedení; 100% ochrana proti chybnému zapojení; Rozteč 5 mm; 6pól.; Světle šedá	www.wago.com/722-136/005-000
	Obj. č.: 722-136/005-000/039-000 Female connector for rail-mount terminal blocks; Rovné provedení; 100% ochrana proti chybnému zapojení; Blokovací západka; Rozteč 5 mm; 6pól.; Světle šedá	www.wago.com/722-136/005-000/039-000
	Obj. č.: 722-137/005-000 Female connector for rail-mount terminal blocks; Rovné provedení; 100% ochrana proti chybnému zapojení; Rozteč 5 mm; 7pól.; Světle šedá	www.wago.com/722-137/005-000
	Obj. č.: 722-137/005-000/039-000 Female connector for rail-mount terminal blocks; Rovné provedení; 100% ochrana proti chybnému zapojení; Blokovací západka; Rozteč 5 mm; 7pól.; Světle šedá	www.wago.com/722-137/005-000/039-000
	Obj. č.: 722-138/005-000 Female connector for rail-mount terminal blocks; Rovné provedení; 100% ochrana proti chybnému	

	zapojení; Rozteč 5 mm; 8pól.; Světle šedá	www.wago.com/722-138/005-000
	Obj. č.: 722-138/005-000/039-000 Female connector for rail-mount terminal blocks; Rovné provedení; 100% ochrana proti chybnému zapojení; Blokovací západka; Rozteč 5 mm; 8pól.; Světle šedá	www.wago.com/722-138/005-000/039-000
	Obj. č.: 722-139/005-000 Female connector for rail-mount terminal blocks; Rovné provedení; 100% ochrana proti chybnému zapojení; Rozteč 5 mm; 9pól.; Světle šedá	www.wago.com/722-139/005-000
	Obj. č.: 722-139/005-000/039-000 Female connector for rail-mount terminal blocks; Rovné provedení; 100% ochrana proti chybnému zapojení; Blokovací západka; Rozteč 5 mm; 9pól.; Světle šedá	www.wago.com/722-139/005-000/039-000
	Obj. č.: 722-140/005-000 Female connector for rail-mount terminal blocks; Rovné provedení; 100% ochrana proti chybnému zapojení; Rozteč 5 mm; 10pól.; Světle šedá	www.wago.com/722-140/005-000
	Obj. č.: 722-140/005-000/039-000 Female connector for rail-mount terminal blocks; Rovné provedení; 100% ochrana proti chybnému zapojení; Blokovací západka; Rozteč 5 mm; 10pól.; Světle šedá	www.wago.com/722-140/005-000/039-000
	Obj. č.: 722-141/005-000 Female connector for rail-mount terminal blocks; Rovné provedení; 100% ochrana proti chybnému zapojení; Rozteč 5 mm; 11pól.; Světle šedá	www.wago.com/722-141/005-000
	Obj. č.: 722-142/005-000 Female connector for rail-mount terminal blocks; Rovné provedení; 100% ochrana proti chybnému zapojení; Rozteč 5 mm; 12pól.; Světle šedá	www.wago.com/722-142/005-000
	Obj. č.: 722-142/005-007/039-000 Female connector for rail-mount terminal blocks; Šedá	www.wago.com/722-142/005-007/039-000
	Obj. č.: 722-143/005-000 Female connector for rail-mount terminal blocks; Rovné provedení; 100% ochrana proti chybnému zapojení; Rozteč 5 mm; 13pól.; Světle šedá	www.wago.com/722-143/005-000
	Obj. č.: 722-144/005-000 Female connector for rail-mount terminal blocks; straight; 100% protected against mismating; Pin spacing 5 mm; 14-pole; light gray	www.wago.com/722-144/005-000
	Obj. č.: 722-144/005-000/039-000 Female connector for rail-mount terminal blocks; Rovné provedení; 100% ochrana proti chybnému zapojení; Blokovací západka; Rozteč 5 mm; 14pól.; Světle šedá	www.wago.com/722-144/005-000/039-000
	Obj. č.: 722-145/005-000 Female connector for rail-mount terminal blocks; Rovné provedení; 100% ochrana proti chybnému zapojení; Rozteč 5 mm; 15pól.; Světle šedá	www.wago.com/722-145/005-000
	Obj. č.: 722-146/005-000 Female connector for rail-mount terminal blocks; Rovné provedení; 100% ochrana proti chybnému zapojení; Rozteč 5 mm; 16pól.; Světle šedá	www.wago.com/722-146/005-000
	Obj. č.: 722-146/005-000/039-000 Female connector for rail-mount terminal blocks; straight; 100% protected against mismating;	



Locking lever; Pin spacing 5 mm; 16-pole; light gray

www.wago.com/722-146/005-000/039-000



Obj. č.: 722-150/005-000

Female connector for rail-mount terminal blocks; Rovné provedení; 100% ochrana proti chybnému zapojení; Rozteč 5 mm; 20pól.; Světle šedá

www.wago.com/722-150/005-000



Obj. č.: 722-150/005-000/039-000

Female connector for rail-mount terminal blocks; Rovné provedení; 100% ochrana proti chybnému zapojení; Blokovací západka; Rozteč 5 mm; 20pól.; Světle šedá

www.wago.com/722-150/005-000/039-000



Obj. č.: 722-232/005-000

Female connector for rail-mount terminal blocks; Úhlové provedení; 100% ochrana proti chybnému zapojení; Rozteč 5 mm; 3pól.; Světle šedá

www.wago.com/722-232/005-000



Obj. č.: 722-232/005-000/039-000

Female connector for rail-mount terminal blocks; Úhlové provedení; 100% ochrana proti chybnému zapojení; Blokovací západka; Rozteč 5 mm; 3pól.; Světle šedá

www.wago.com/722-232/005-000/039-000



Obj. č.: 722-233/005-000

Female connector for rail-mount terminal blocks; Úhlové provedení; 100% ochrana proti chybnému zapojení; Rozteč 5 mm; 3pól.; Světle šedá

www.wago.com/722-233/005-000



Obj. č.: 722-233/005-000/039-000

Female connector for rail-mount terminal blocks; Úhlové provedení; 100% ochrana proti chybnému zapojení; Blokovací západka; Rozteč 5 mm; 3pól.; Světle šedá

www.wago.com/722-233/005-000/039-000



Obj. č.: 722-234/005-000

Female connector for rail-mount terminal blocks; Úhlové provedení; 100% ochrana proti chybnému zapojení; Rozteč 5 mm; 4pól.; Světle šedá

www.wago.com/722-234/005-000



Obj. č.: 722-234/005-000/039-000

Female connector for rail-mount terminal blocks; Úhlové provedení; 100% ochrana proti chybnému zapojení; Blokovací západka; Rozteč 5 mm; 4pól.; Světle šedá

www.wago.com/722-234/005-000/039-000



Obj. č.: 722-235/005-000

Female connector for rail-mount terminal blocks; Úhlové provedení; 100% ochrana proti chybnému zapojení; Rozteč 5 mm; 5pól.; Světle šedá

www.wago.com/722-235/005-000



Obj. č.: 722-235/005-000/039-000

Female connector for rail-mount terminal blocks; Úhlové provedení; 100% ochrana proti chybnému zapojení; Blokovací západka; Rozteč 5 mm; 5pól.; Světle šedá

www.wago.com/722-235/005-000/039-000



Obj. č.: 722-236/005-000

Female connector for rail-mount terminal blocks; Úhlové provedení; 100% ochrana proti chybnému zapojení; Rozteč 5 mm; 6pól.; Světle šedá

www.wago.com/722-236/005-000



Obj. č.: 722-236/005-000/039-000

Female connector for rail-mount terminal blocks; Úhlové provedení; 100% ochrana proti chybnému zapojení; Blokovací západka; Rozteč 5 mm; 6pól.; Světle šedá

www.wago.com/722-236/005-000/039-000

















Obj. č.: 722-237/005-000

Female connector for rail-mount terminal blocks; Úhlové provedení; 100% ochrana proti chybnému zapojení; Rozteč 5 mm; 7pól.; Světle šedá

www.wago.com/722-237/005-000

Obj. č.: 722-237/005-000/039-000

Female connector for rail-mount terminal blocks; Úhlové provedení; 100% ochrana proti chybnému

	zapojení; Blokovací západka; Rozteč 5 mm; 7pól.; Světle šedá	www.wago.com/722-237/005-000/039-000
	Obj. č.: 722-238/005-000 Female connector for rail-mount terminal blocks; Úhlové provedení; 100% ochrana proti chybnému zapojení; Rozteč 5 mm; 8pól.; Světle šedá	www.wago.com/722-238/005-000
	Obj. č.: 722-239/005-000 Female connector for rail-mount terminal blocks; Úhlové provedení; 100% ochrana proti chybnému zapojení; Rozteč 5 mm; 9pól.; Světle šedá	www.wago.com/722-239/005-000
	Obj. č.: 722-239/005-000/039-000 Female connector for rail-mount terminal blocks; angled; 100% protected against mismatching; Locking lever; Pin spacing 5 mm; 9-pole; light gray	www.wago.com/722-239/005-000/039-000
	Obj. č.: 722-240/005-000 Female connector for rail-mount terminal blocks; Úhlové provedení; 100% ochrana proti chybnému zapojení; Rozteč 5 mm; 10pól.; Světle šedá	www.wago.com/722-240/005-000
	Obj. č.: 722-240/005-000/039-000 Female connector for rail-mount terminal blocks; Úhlové provedení; 100% ochrana proti chybnému zapojení; Blokovací západka; Rozteč 5 mm; 10pól.; Světle šedá	www.wago.com/722-240/005-000/039-000
	Obj. č.: 722-241/005-000 Female connector for rail-mount terminal blocks; Úhlové provedení; 100% ochrana proti chybnému zapojení; Rozteč 5 mm; 11pól.; Světle šedá	www.wago.com/722-241/005-000
	Obj. č.: 722-242/005-000 Female connector for rail-mount terminal blocks; Úhlové provedení; 100% ochrana proti chybnému zapojení; Rozteč 5 mm; 12pól.; Světle šedá	www.wago.com/722-242/005-000
	Obj. č.: 722-242/005-000/039-000 Female connector for rail-mount terminal blocks; angled; 100% protected against mismatching; Locking lever; Pin spacing 5 mm; 12-pole; light gray	www.wago.com/722-242/005-000/039-000
	Obj. č.: 722-243/005-000 Female connector for rail-mount terminal blocks; angled; 100% protected against mismatching; Pin spacing 5 mm; 13-pole; light gray	www.wago.com/722-243/005-000
	Obj. č.: 722-244/005-000 Female connector for rail-mount terminal blocks; Úhlové provedení; 100% ochrana proti chybnému zapojení; Rozteč 5 mm; 14pól.; Světle šedá	www.wago.com/722-244/005-000
	Obj. č.: 722-244/005-000/039-000 Female connector for rail-mount terminal blocks; Úhlové provedení; 100% ochrana proti chybnému zapojení; Blokovací západka; Rozteč 5 mm; 14pól.; Světle šedá	www.wago.com/722-244/005-000/039-000
	Obj. č.: 722-246/005-000 Female connector for rail-mount terminal blocks; Úhlové provedení; 100% ochrana proti chybnému zapojení; Rozteč 5 mm; 16pól.; Světle šedá	www.wago.com/722-246/005-000
	Obj. č.: 722-246/005-000/039-000 Female connector for rail-mount terminal blocks; Úhlové provedení; 100% ochrana proti chybnému zapojení; Blokovací západka; Rozteč 5 mm; 16pól.; Světle šedá	www.wago.com/722-246/005-000/039-000
	Obj. č.: 722-250/005-000 Female connector for rail-mount terminal blocks; Úhlové provedení; 100% ochrana proti chybnému	



zapojení; Rozteč 5 mm; 20pól.; Světle šedá

www.wago.com/722-250/005-000

Protective Warning Marker

Obj. č.: 280-415
 Výstražný kryt; S černým symbolem blesku; Pro 5 svorek; Žlutá

www.wago.com/280-415

Insulation stop

Obj. č.: 280-470
 Izolační zarážka; 0,08–0,2 mm² „e“ (0,14 mm² „f“); 5 ks/pás; Bílá

www.wago.com/280-470

Obj. č.: 280-471
 Izolační zarážka; 0,25–0,5 mm²; 5 ks/pás; Světle šedá

www.wago.com/280-471

Obj. č.: 280-472
 Izolační zarážka; 0,75–1 mm²; 5 ks/pás

www.wago.com/280-472

ferrule

Obj. č.: 216-101
 Dutinka; Objímka na 0,5 mm² / AWG 22; Bez plastového límce; Galvanicky pocínováno

www.wago.com/216-101

Obj. č.: 216-102
 Dutinka; Objímka na 0,75 mm² / AWG 20; Bez plastového límce; Galvanicky pocínováno

www.wago.com/216-102

Obj. č.: 216-103
 Dutinka; Objímka na 1 mm² / AWG 18; Bez plastového límce; Galvanicky pocínováno

www.wago.com/216-103

Obj. č.: 216-104
 Dutinka; Objímka na 1,5 mm² / AWG 16; Bez plastového límce; Galvanicky pocínováno

www.wago.com/216-104

Obj. č.: 216-201
 Ferrule; Sleeve for 0.5 mm² / 20 AWG; insulated; electro-tin plated; white

www.wago.com/216-201

Obj. č.: 216-202
 Ferrule; Sleeve for 0.75 mm² / 18 AWG; insulated; electro-tin plated; gray

www.wago.com/216-202

Obj. č.: 216-203
 Dutinka; Objímka na 1 mm² / AWG 18; S plastovým límcem; Galvanicky pocínováno; Červená

www.wago.com/216-203

Obj. č.: 216-204
 Dutinka; Objímka na 1,5 mm² / AWG 16; S plastovým límcem; Galvanicky pocínováno; Černá

www.wago.com/216-204

Obj. č.: 216-301
 Dutinka; Objímka na 0,25 mm² / AWG 24; S plastovým límcem; Galvanicky pocínováno; Žlutá

www.wago.com/216-301

Obj. č.: 216-302
 Ferrule; Sleeve for 0.34 mm² / 22 AWG; insulated; electro-tin plated; green

www.wago.com/216-302

check



















Obj. č.: 249-141
 Modul pro zkušební zástrčku L; Možnost řadového připojení; S pružnou kontaktní vidlicí; Středový modul; 1,50 mm²; Šedá

















www.wago.com/249-141

Carrier rail

Obj. č.: 210-112
 Ocelová nosná lišta; 35 × 7,5 mm; Tloušťka 1 mm; Délka 2 m; Děrovaná; Dle normy EN 60715; Šířka otvorů 25 mm; vzdálenost mezi otvory 36 mm

www.wago.com/210-112

	Obj. č.: 210-113 Ocelová nosná lišta; 35 × 7,5 mm; Tloušťka 1 mm; Délka 2 m; Neděrovaná; Dle normy EN 60715	www.wago.com/210-113
	Obj. č.: 210-114 Ocelová nosná lišta; 35 × 15 mm; Tloušťka 1,5 mm; Délka 2 m; Neděrovaná; Podobné EN 60715	www.wago.com/210-114
	Obj. č.: 210-115 Ocelová nosná lišta; 35 × 7,5 mm; Tloušťka 1 mm; Délka 2 m; Děrovaná; Dle normy EN 60715; Šířka otvorů 18 mm; vzdálenost mezi otvory 25 mm	www.wago.com/210-115
	Obj. č.: 210-118 Ocelová nosná lišta; 35 × 15 mm; Tloušťka 2,3 mm; Délka 2 m; Neděrovaná; Dle normy EN 60715	www.wago.com/210-118
	Obj. č.: 210-196 Hliníková nosná lišta; 35 × 8,2 mm; Tloušťka 1,6 mm; Délka 2 m; Neděrovaná; Podobné EN 60715; Stříbrná	www.wago.com/210-196
	Obj. č.: 210-197 Ocelová nosná lišta; 35 × 15 mm; Tloušťka 1,5 mm; Délka 2 m; Děrovaná; Podobné EN 60715	www.wago.com/210-197
	Obj. č.: 210-198 Měděná nosná lišta; 35 × 15 mm; Tloušťka 2,3 mm; Délka 2 m; Neděrovaná; Dle normy EN 60715; Měděná	www.wago.com/210-198
	Obj. č.: 210-504 Ocelová nosná lišta; 35 × 7,5 mm; Tloušťka 1 mm; Délka 2 m; Děrovaná; Pásově zinkováno; Dle normy EN 60715	www.wago.com/210-504
	Obj. č.: 210-505 Ocelová nosná lišta; 35 × 7,5 mm; Tloušťka 1 mm; Délka 2 m; Neděrovaná; Pásově zinkováno; Dle normy EN 60715	www.wago.com/210-505
	Obj. č.: 210-506 Ocelová nosná lišta; 35 × 15 mm; Tloušťka 1,5 mm; Délka 2 m; Neděrovaná; Pásově zinkováno; Podobné EN 60715	www.wago.com/210-506
	Obj. č.: 210-508 Ocelová nosná lišta; 35 × 15 mm; Tloušťka 1,5 mm; Délka 2 m; Děrovaná; Pásově zinkováno; Podobné EN 60715	www.wago.com/210-508
Marking accessories		
	Obj. č.: 2009-115 WMB Inline; Pro Smart Printer; Na cívce; Flexibilní, 5–5,2 mm; Bez potisku; Možnost naklapnutí; Bílá	www.wago.com/2009-115
	Obj. č.: 2009-115/000-002 WMB Inline; Pro Smart Printer; Na cívce; Flexibilní, 5–5,2 mm; Bez potisku; Možnost naklapnutí; Žlutá	www.wago.com/2009-115/000-002
	Obj. č.: 2009-115/000-006 WMB Inline; Pro Smart Printer; Na cívce; Flexibilní, 5–5,2 mm; Bez potisku; Možnost naklapnutí; Modrá	www.wago.com/2009-115/000-006
	Obj. č.: 2009-115/000-007 WMB Inline; Pro Smart Printer; Na cívce; Flexibilní, 5–5,2 mm; Bez potisku; Možnost naklapnutí; Šedá	www.wago.com/2009-115/000-007
	Obj. č.: 2009-115/000-012 WMB Inline; Pro Smart Printer; Na cívce; Flexibilní, 5–5,2 mm; Bez potisku; Možnost naklapnutí; Oranžová	www.wago.com/2009-115/000-012
	Obj. č.: 2009-115/000-017 WMB Inline; Pro Smart Printer; Na cívce; Flexibilní, 5–5,2 mm; Bez potisku; Možnost naklapnutí; Světle zelená	www.wago.com/2009-115/000-017

	Obj. č.: 2009-115/000-023 WMB Inline; Pro Smart Printer; Na cívce; Flexibilní, 5–5,2 mm; Bez potisku; Možnost naklapnutí; Zelená	www.wago.com/2009-115/000-023
	Obj. č.: 2009-115/000-024 WMB Inline; Pro Smart Printer; Na cívce; Flexibilní, 5–5,2 mm; Bez potisku; Možnost naklapnutí; Fialová	www.wago.com/2009-115/000-024
	Obj. č.: 209-128 Adaptér	www.wago.com/209-128
	Obj. č.: 209-185 Adaptér	www.wago.com/209-185
	Obj. č.: 210-612 Popisovací páska; K vlastnímu popisování; Bez potisku; Samolepicí; Transparentní	www.wago.com/210-612
	Obj. č.: 793-501 Popisovací karta WMB; Jako karta; Neflexibilní; Bez potisku; Možnost naklapnutí; Bílá	www.wago.com/793-501
	Obj. č.: 793-501/000-002 Popisovací karta WMB; Jako karta; Neflexibilní; Bez potisku; Možnost naklapnutí; Bílá	www.wago.com/793-501/000-002
	Obj. č.: 793-501/000-005 Popisovací karta WMB; Jako karta; Neflexibilní; Bez potisku; Možnost naklapnutí; Červená	www.wago.com/793-501/000-005
	Obj. č.: 793-501/000-006 Popisovací karta WMB; Jako karta; Neflexibilní; Bez potisku; Možnost naklapnutí; Modrá	www.wago.com/793-501/000-006
	Obj. č.: 793-501/000-007 Popisovací karta WMB; Jako karta; Neflexibilní; Bez potisku; Možnost naklapnutí; Šedá	www.wago.com/793-501/000-007
	Obj. č.: 793-501/000-012 Popisovací karta WMB; Jako karta; Neflexibilní; Bez potisku; Možnost naklapnutí; Oranžová	www.wago.com/793-501/000-012
	Obj. č.: 793-501/000-017 Popisovací karta WMB; Jako karta; Neflexibilní; Bez potisku; Možnost naklapnutí; Světle zelená	www.wago.com/793-501/000-017
	Obj. č.: 793-501/000-023 Popisovací karta WMB; Jako karta; Neflexibilní; Bez potisku; Možnost naklapnutí; Zelená	www.wago.com/793-501/000-023
	Obj. č.: 793-501/000-024 Popisovací karta WMB; Jako karta; Neflexibilní; Bez potisku; Možnost naklapnutí; Fialová	www.wago.com/793-501/000-024
	Obj. č.: 793-5501 Popisovací karta WMB; Jako karta; Pro svorky o šířce 5–17,5 mm; Flexibilní, 5–5,2 mm; Bez potisku; Možnost naklapnutí; Bílá	www.wago.com/793-5501
	Obj. č.: 793-5501/000-002 Popisovací karta WMB; Jako karta; Pro svorky o šířce 5–17,5 mm; Flexibilní, 5–5,2 mm; Bez potisku; Možnost naklapnutí; Žlutá	www.wago.com/793-5501/000-002

**Obj. č.: 793-5501/000-005**

Popisovací karta WMB; Jako karta; Flexibilní, 5–5,2 mm; Bez potisku; Možnost naklapnutí; Červená

www.wago.com/793-5501/000-005**Obj. č.: 793-5501/000-006**

Popisovací karta WMB; Jako karta; Flexibilní, 5–5,2 mm; Bez potisku; Možnost naklapnutí; Modrá

www.wago.com/793-5501/000-006**Obj. č.: 793-5501/000-007**

Popisovací karta WMB; Jako karta; Flexibilní, 5–5,2 mm; Bez potisku; Možnost naklapnutí; Šedá

www.wago.com/793-5501/000-007**Obj. č.: 793-5501/000-012**

Popisovací karta WMB; Jako karta; Flexibilní, 5–5,2 mm; Bez potisku; Možnost naklapnutí; Oranžová

www.wago.com/793-5501/000-012**Obj. č.: 793-5501/000-017**

Popisovací karta WMB; Jako karta; Flexibilní, 5–5,2 mm; Bez potisku; Možnost naklapnutí; Světle zelená

www.wago.com/793-5501/000-017**Obj. č.: 793-5501/000-023**

Popisovací karta WMB; Jako karta; Flexibilní, 5–5,2 mm; Bez potisku; Možnost naklapnutí; Zelená

www.wago.com/793-5501/000-023**Obj. č.: 793-5501/000-024**

Popisovací karta WMB; Jako karta; Flexibilní, 5–5,2 mm; Bez potisku; Možnost naklapnutí; Fialová

www.wago.com/793-5501/000-024**Ke stažení****Documentation****Additional Information**

Technical explanations	03-Apr-2019	pdf 2,1 MB	Stáhnout
------------------------	-------------	---------------	----------

CAD/CAE-Data**CAD data**

2D/3D Models 280-626	URL	Stáhnout
----------------------	-----	----------

CAE data

EPLAN Data Portal 280-626	Stáhnout
---------------------------	----------

WSCAD Universe 280-626	Stáhnout
------------------------	----------

Handling Instructions

Assembly

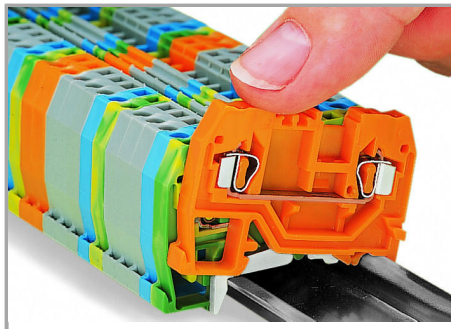

Snapping a terminal block onto the carrier rail.

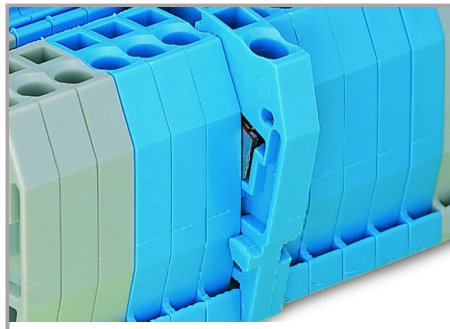

Quick assembly keys prevent reverse mounting.

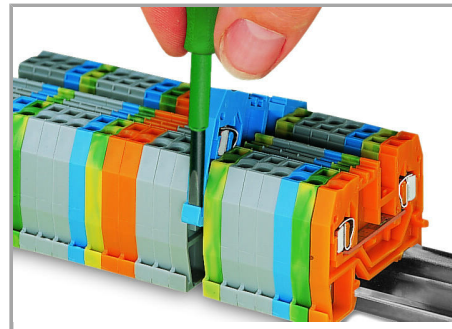

Removing a terminal block from the assembly.

Inserting a conductor

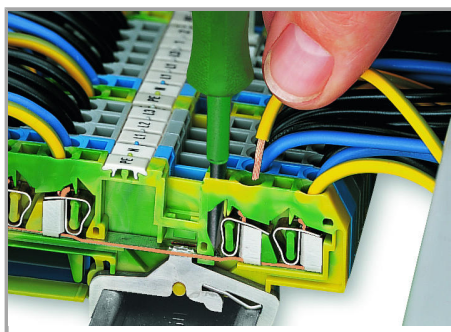

CAGE CLAMP® connection

Inserting a conductor.

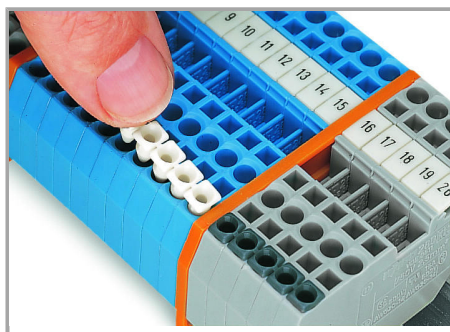

Inserting insulation stops.

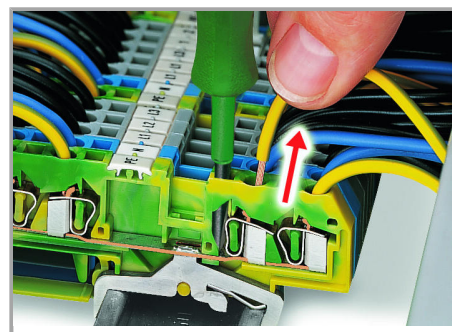

CAGE CLAMP®-Anschluss

Leiter lösen.

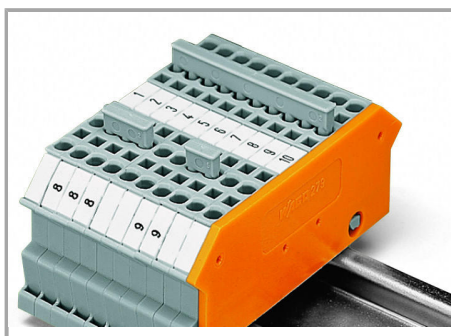

Marking
Značky vyhrazeny.

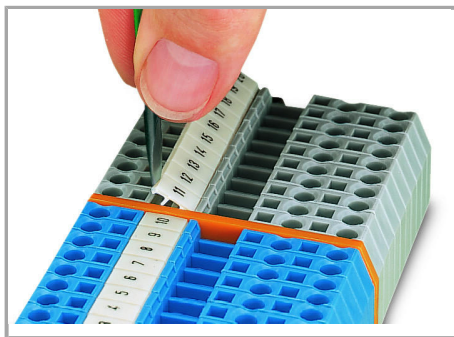

Marking via WMB Multi Marking System.

Změny vyhrazeny.

WAGO Elektro spol. sr. o.
Rozvodova 1116/36
143 00 Praha 12 - Modřany
Tel.: +420 261 090 143
Email: info.cz@wago.com, wago-cz@wago.com

Máte otázky ohledně našich produktů?
Kdykoli nám zavolejte na číslo +420 261 090 143.