

## Datový list | Objednací číslo: 280-612

2vodičová rozpojovací svorka; Na DIN lištu 35 × 15 a 35 × 7,5; 2,5 mm<sup>2</sup>;  
CAGE CLAMP®; 2,50 mm<sup>2</sup>; Šedá

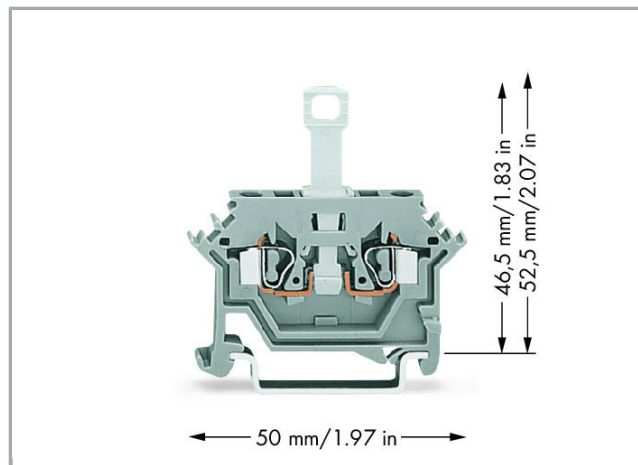

[www.wago.com/280-612](http://www.wago.com/280-612)

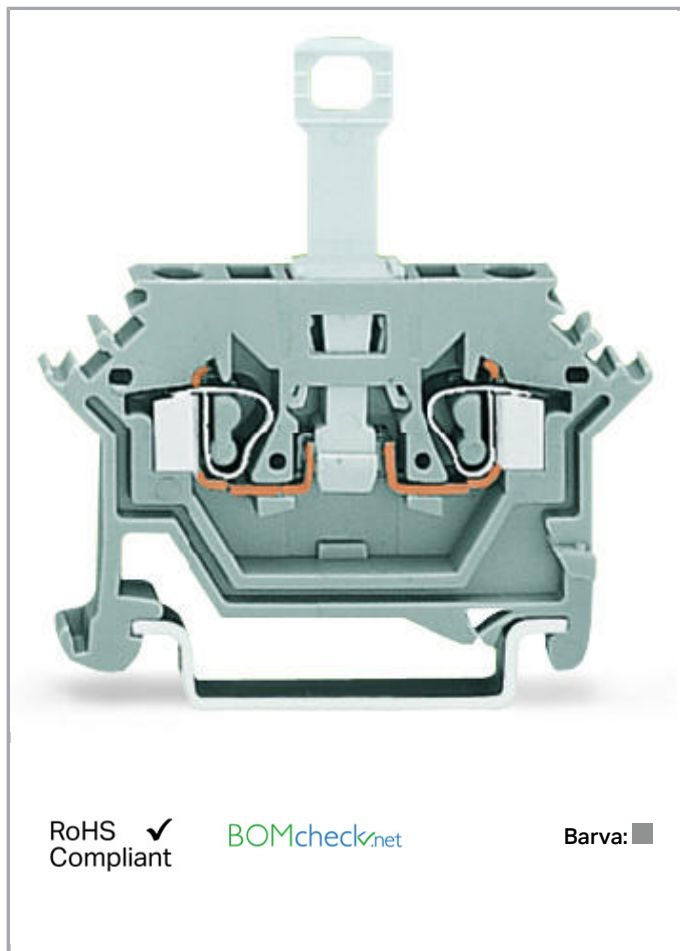

### Popis položky

#### Upozornění:

##### Terminating Aluminum Conductors

WAGO spring clamp terminal blocks are suitable for solid aluminum conductors up to 4 mm<sup>2</sup>/12 AWG if WAGO "Alu-Plus" Contact Paste is used for termination.

#### "Alu-Plus" Contact Paste Advantages:

- Automatically destroys the oxide film during clamping.
- Prevents fresh oxidation at the clamping point.
- Prevents electrolytic corrosion between aluminum and copper conductors (in the same terminal block).
- Provides long-term protection against corrosion.

Using terminal blocks with CAGE CLAMP® Spring Pressure Connection Technology, **aluminum conductors must first be cleaned with a blade and**



then immediately be inserted into the clamping units filled with "Alu-Plus" Contact Paste.

It is also possible to apply WAGO "Alu-Plus" **additionally** on the whole surface of the aluminum conductor before termination.

Please note that the nominal currents must be adapted to the reduced conductivity of the aluminum conductors:

2.5 mm<sup>2</sup> (14 AWG) = 16 A

4 mm<sup>2</sup> (12 AWG) = 22 A

## Data

### Elektrické parametry

#### Ratings per IEC/EN 60664-1

Návrhové napětí (III / 3)	400 V
Návrhové rázové napětí (III / 3)	6 kV
Jmenovitý proud	10 A
Legenda (návrhové hodnoty)	(III / 3) ≙ kategorie přepětí III / stupeň znečištění 3

#### Údaje o připojení

Připojovací technika	CAGE CLAMP®
Způsob ovládání	Ovládací nástroj
Materiály připojitelných vodičů	Měď Hliník
Plný vodič	0,08 ... 2,5 mm <sup>2</sup> / 28 ... 12 AWG
Jemně laněný vodič	0,08 ... 2,5 mm <sup>2</sup> / 28 ... 12 AWG
Délka odizolování	8 ... 9 mm / 0.31 ... 0.35 palec
Celkový počet kontaktních míst	2
Celkový počet potenciálů	2
Počet úrovní	1
Způsob zapojení	čelní připojení
Upozornění (průřez vodiče)	12 AWG: THHN, THWN

#### Geometrické údaje

Šířka	5 mm / 0.197 inch
Výška od horní hrany lišty DIN 35	52,5 mm / 2.067 inch
Hloubka	50 mm / 1.969 inch

#### Mechanické parametry

Provedení	Horizontální provedení
Způsob montáže	Lišta DIN 35
Úroveň popisování	Boční popis

## Údaje o materiálu



barva	Šedá
Izolační materiál	Polyamid 66 (PA 66)
Požární zatížení	0.105 MJ
Hmotnost	5.4 g

## Obchodní údaje

Product Group	1 (Rail Mounted Terminal Blocks)
Druh balení	BOX
Country of origin	DE
GTIN	4044918538527
Customs Tariff No.	85369010000

## Atesty/certifikáty

## Specifické atesty jednotlivých států

Logo	Schválení	Doplňkový text schválení	Název certifikátu
	CCA DEKRA Certification B.V.	EN 60947	2157201.01
	CSA DEKRA Certification B.V.	C22.2	1536071

## Atesty pro použití v lodním průmyslu



Logo	Schválení	Doplňkový text schválení	Název certifikátu
	ABS American Bureau of Shipping	EN 60947	14- HG1293677- PDA
	BV Bureau Veritas S.A.	EN 60947	07436/E0 BV
	DNV GL Det Norske Veritas, Germanischer Lloyd	-	TAE00001V2
	LR Lloyds Register	EN 60947	91/20112 (E9)

## Atesty UL

Logo	Schválení	Doplňkový text schválení	Název certifikátu
	UL Underwriters Laboratories Inc.	UL 1059	20170731- E45172

## Kompatibilní produkty

## tools

















	<b>Obj. č.: 210-657</b> Ovládací nástroj; Břit: 3,5 × 0,5 mm; S částečně izolovanou rukojetí; Krátké	<a href="http://www.wago.com/210-657">www.wago.com/210-657</a>
	<b>Obj. č.: 210-658</b> Ovládací nástroj; Břit: 3,5 × 0,5 mm; S částečně izolovanou rukojetí; Úhlové provedení; Krátké	<a href="http://www.wago.com/210-658">www.wago.com/210-658</a>
	<b>Obj. č.: 210-720</b> Ovládací nástroj; Břit: 3,5 × 0,5 mm; S částečně izolovanou rukojetí	<a href="http://www.wago.com/210-720">www.wago.com/210-720</a>















## check















	<b>Obj. č.: 249-141</b> Modul pro zkušební zástrčku L; Možnost řadového připojení; S pružnou kontaktní vidlicí; Středový modul; 1,50 mm <sup>2</sup> ; Šedá	<a href="http://www.wago.com/249-141">www.wago.com/249-141</a>
---	--	--















## ferrule

	<b>Obj. č.: 216-101</b> Dutinka; Objímka na 0,5 mm <sup>2</sup> / AWG 22; Bez plastového límce; Galvanicky pocínováno	<a href="http://www.wago.com/216-101">www.wago.com/216-101</a>
	<b>Obj. č.: 216-102</b> Dutinka; Objímka na 0,75 mm <sup>2</sup> / AWG 20; Bez plastového límce; Galvanicky pocínováno	<a href="http://www.wago.com/216-102">www.wago.com/216-102</a>
	<b>Obj. č.: 216-103</b> Dutinka; Objímka na 1 mm <sup>2</sup> / AWG 18; Bez plastového límce; Galvanicky pocínováno	<a href="http://www.wago.com/216-103">www.wago.com/216-103</a>
	<b>Obj. č.: 216-104</b> Dutinka; Objímka na 1,5 mm <sup>2</sup> / AWG 16; Bez plastového límce; Galvanicky pocínováno	<a href="http://www.wago.com/216-104">www.wago.com/216-104</a>
	<b>Obj. č.: 216-201</b> Ferrule; Sleeve for 0.5 mm <sup>2</sup> / 20 AWG; insulated; electro-tin plated; white	<a href="http://www.wago.com/216-201">www.wago.com/216-201</a>

	<b>Obj. č.: 216-202</b> Ferrule; Sleeve for 0.75 mm <sup>2</sup> / 18 AWG; insulated; electro-tin plated; gray	<a href="http://www.wago.com/216-202">www.wago.com/216-202</a>
	<b>Obj. č.: 216-203</b> Dutinka; Objímka na 1 mm <sup>2</sup> / AWG 18; S plastovým límcem; Galvanicky pocínováno; Červená	<a href="http://www.wago.com/216-203">www.wago.com/216-203</a>
	<b>Obj. č.: 216-204</b> Dutinka; Objímka na 1,5 mm <sup>2</sup> / AWG 16; S plastovým límcem; Galvanicky pocínováno; Černá	<a href="http://www.wago.com/216-204">www.wago.com/216-204</a>
	<b>Obj. č.: 216-301</b> Dutinka; Objímka na 0,25 mm <sup>2</sup> / AWG 24; S plastovým límcem; Galvanicky pocínováno; Žlutá	<a href="http://www.wago.com/216-301">www.wago.com/216-301</a>
	<b>Obj. č.: 216-302</b> Ferrule; Sleeve for 0.34 mm <sup>2</sup> / 22 AWG; insulated; electro-tin plated; green	<a href="http://www.wago.com/216-302">www.wago.com/216-302</a>
<b>End plate</b>		
	<b>Obj. č.: 280-328</b> Přepážka; Tloušťka 2 mm; S přesahem; Oranžová	<a href="http://www.wago.com/280-328">www.wago.com/280-328</a>
	<b>Obj. č.: 280-330</b> Koncová bočnice a separátor; Tloušťka 2,5 mm; Šedá	<a href="http://www.wago.com/280-330">www.wago.com/280-330</a>
	<b>Obj. č.: 280-331</b> Koncová bočnice a separátor; Tloušťka 2,5 mm; Oranžová	<a href="http://www.wago.com/280-331">www.wago.com/280-331</a>
	<b>Obj. č.: 280-338</b> Přepážka; Tloušťka 2 mm; S přesahem; Šedá	<a href="http://www.wago.com/280-338">www.wago.com/280-338</a>
<b>Insulation stop</b>		
	<b>Obj. č.: 280-470</b> Izolační zarážka; 0,08–0,2 mm <sup>2</sup> „e“ (0,14 mm <sup>2</sup> „f“); 5 ks/pás; Bílá	<a href="http://www.wago.com/280-470">www.wago.com/280-470</a>
	<b>Obj. č.: 280-471</b> Izolační zarážka; 0,25–0,5 mm <sup>2</sup> ; 5 ks/pás; Světle šedá	<a href="http://www.wago.com/280-471">www.wago.com/280-471</a>
	<b>Obj. č.: 280-472</b> Izolační zarážka; 0,75–1 mm <sup>2</sup> ; 5 ks/pás	<a href="http://www.wago.com/280-472">www.wago.com/280-472</a>
<b>Carrier rail</b>		
	<b>Obj. č.: 210-112</b> Ocelová nosná lišta; 35 × 7,5 mm; Tloušťka 1 mm; Délka 2 m; Děrovaná; Dle normy EN 60715; Šířka otvorů 25 mm; vzdálenost mezi otvory 36 mm	<a href="http://www.wago.com/210-112">www.wago.com/210-112</a>
	<b>Obj. č.: 210-113</b> Ocelová nosná lišta; 35 × 7,5 mm; Tloušťka 1 mm; Délka 2 m; Neděrovaná; Dle normy EN 60715	<a href="http://www.wago.com/210-113">www.wago.com/210-113</a>
	<b>Obj. č.: 210-114</b> Ocelová nosná lišta; 35 × 15 mm; Tloušťka 1,5 mm; Délka 2 m; Neděrovaná; Podobné EN 60715	<a href="http://www.wago.com/210-114">www.wago.com/210-114</a>
	<b>Obj. č.: 210-115</b> Ocelová nosná lišta; 35 × 7,5 mm; Tloušťka 1 mm; Délka 2 m; Děrovaná; Dle normy EN 60715; Šířka otvorů 18 mm; vzdálenost mezi otvory 25 mm	<a href="http://www.wago.com/210-115">www.wago.com/210-115</a>
	<b>Obj. č.: 210-118</b> Ocelová nosná lišta; 35 × 15 mm; Tloušťka 2,3 mm; Délka 2 m; Neděrovaná; Dle normy EN 60715	<a href="http://www.wago.com/210-118">www.wago.com/210-118</a>
	<b>Obj. č.: 210-196</b> Hliníková nosná lišta; 35 × 8,2 mm; Tloušťka 1,6 mm; Délka 2 m; Neděrovaná; Podobné EN 60715; Stříbrná	<a href="http://www.wago.com/210-196">www.wago.com/210-196</a>

	<b>Obj. č.: 210-197</b> Ocelová nosná lišta; 35 × 15 mm; Tloušťka 1,5 mm; Délka 2 m; Děrovaná; Podobné EN 60715	<a href="http://www.wago.com/210-197">www.wago.com/210-197</a>
	<b>Obj. č.: 210-198</b> Měděná nosná lišta; 35 × 15 mm; Tloušťka 2,3 mm; Délka 2 m; Neděrovaná; Dle normy EN 60715; Měděná	<a href="http://www.wago.com/210-198">www.wago.com/210-198</a>
	<b>Obj. č.: 210-504</b> Ocelová nosná lišta; 35 × 7,5 mm; Tloušťka 1 mm; Délka 2 m; Děrovaná; Pásově zinkováno; Dle normy EN 60715	<a href="http://www.wago.com/210-504">www.wago.com/210-504</a>
	<b>Obj. č.: 210-505</b> Ocelová nosná lišta; 35 × 7,5 mm; Tloušťka 1 mm; Délka 2 m; Neděrovaná; Pásově zinkováno; Dle normy EN 60715	<a href="http://www.wago.com/210-505">www.wago.com/210-505</a>
	<b>Obj. č.: 210-506</b> Ocelová nosná lišta; 35 × 15 mm; Tloušťka 1,5 mm; Délka 2 m; Neděrovaná; Pásově zinkováno; Podobné EN 60715	<a href="http://www.wago.com/210-506">www.wago.com/210-506</a>
	<b>Obj. č.: 210-508</b> Ocelová nosná lišta; 35 × 15 mm; Tloušťka 1,5 mm; Délka 2 m; Děrovaná; Pásově zinkováno; Podobné EN 60715	<a href="http://www.wago.com/210-508">www.wago.com/210-508</a>
<b>Protective Warning Marker</b>		
	<b>Obj. č.: 280-415</b> Výstražný kryt; S černým symbolem blesku; Pro 5 svorek; Žlutá	<a href="http://www.wago.com/280-415">www.wago.com/280-415</a>
<b>Female plug</b>		
	<b>Obj. č.: 232-132/005-000</b> Female connector for rail-mount terminal blocks; Rovné provedení; Rozteč 5 mm; 2pól.; Šedá	<a href="http://www.wago.com/232-132/005-000">www.wago.com/232-132/005-000</a>
	<b>Obj. č.: 232-132/005-000/039-000</b> Female connector for rail-mount terminal blocks; straight; Locking lever; Pin spacing 5 mm; 3-pole; gray	<a href="http://www.wago.com/232-132/005-000/039-000">www.wago.com/232-132/005-000/039-000</a>
	<b>Obj. č.: 232-133/005-000</b> Female connector for rail-mount terminal blocks; Rovné provedení; Rozteč 5 mm; 3pól.; Šedá	<a href="http://www.wago.com/232-133/005-000">www.wago.com/232-133/005-000</a>
	<b>Obj. č.: 232-133/005-000/039-000</b> Female connector for rail-mount terminal blocks; Rovné provedení; Blokovací západka; Rozteč 5 mm; 3pól.; Šedá	<a href="http://www.wago.com/232-133/005-000/039-000">www.wago.com/232-133/005-000/039-000</a>
	<b>Obj. č.: 232-134/005-000</b> Female connector for rail-mount terminal blocks; Rovné provedení; Rozteč 5 mm; 4pól.; Šedá	<a href="http://www.wago.com/232-134/005-000">www.wago.com/232-134/005-000</a>
	<b>Obj. č.: 232-134/005-000/039-000</b> Female connector for rail-mount terminal blocks; Rovné provedení; Blokovací západka; Rozteč 5 mm; 4pól.; Šedá	<a href="http://www.wago.com/232-134/005-000/039-000">www.wago.com/232-134/005-000/039-000</a>
	<b>Obj. č.: 232-135/005-000</b> Female connector for rail-mount terminal blocks; Rovné provedení; Rozteč 5 mm; 5pól.; Šedá	<a href="http://www.wago.com/232-135/005-000">www.wago.com/232-135/005-000</a>
	<b>Obj. č.: 232-135/005-000/039-000</b> Female connector for rail-mount terminal blocks; Rovné provedení; Blokovací západka; Rozteč 5 mm; 5pól.; Šedá	<a href="http://www.wago.com/232-135/005-000/039-000">www.wago.com/232-135/005-000/039-000</a>

	<b>Obj. č.: 232-136/005-000</b> Female connector for rail-mount terminal blocks; Rovné provedení; Rozteč 5 mm; 6pól.; Šedá	<a href="http://www.wago.com/232-136/005-000">www.wago.com/232-136/005-000</a>
	<b>Obj. č.: 232-136/005-000/039-000</b> Female connector for rail-mount terminal blocks; Rovné provedení; Blokovací západka; Rozteč 5 mm; 6pól.; Šedá	<a href="http://www.wago.com/232-136/005-000/039-000">www.wago.com/232-136/005-000/039-000</a>
	<b>Obj. č.: 232-137/005-000</b> Female connector for rail-mount terminal blocks; Rovné provedení; Rozteč 5 mm; 7pól.; Šedá	<a href="http://www.wago.com/232-137/005-000">www.wago.com/232-137/005-000</a>
	<b>Obj. č.: 232-137/005-000/039-000</b> Female connector for rail-mount terminal blocks; Rovné provedení; Blokovací západka; Rozteč 5 mm; 7pól.; Šedá	<a href="http://www.wago.com/232-137/005-000/039-000">www.wago.com/232-137/005-000/039-000</a>
	<b>Obj. č.: 232-138/005-000</b> Female connector for rail-mount terminal blocks; Rovné provedení; Rozteč 5 mm; 8pól.; Šedá	<a href="http://www.wago.com/232-138/005-000">www.wago.com/232-138/005-000</a>
	<b>Obj. č.: 232-138/005-000/039-000</b> Female connector for rail-mount terminal blocks; Rovné provedení; Blokovací západka; Rozteč 5 mm; 8pól.; Šedá	<a href="http://www.wago.com/232-138/005-000/039-000">www.wago.com/232-138/005-000/039-000</a>
	<b>Obj. č.: 232-139/005-000</b> Female connector for rail-mount terminal blocks; Rovné provedení; Rozteč 5 mm; 9pól.; Šedá	<a href="http://www.wago.com/232-139/005-000">www.wago.com/232-139/005-000</a>
	<b>Obj. č.: 232-139/005-000/039-000</b> Female connector for rail-mount terminal blocks; Rovné provedení; Blokovací západka; Rozteč 5 mm; 9pól.; Šedá	<a href="http://www.wago.com/232-139/005-000/039-000">www.wago.com/232-139/005-000/039-000</a>
	<b>Obj. č.: 232-140/005-000</b> Female connector for rail-mount terminal blocks; Rovné provedení; Rozteč 5 mm; 10pól.; Šedá	<a href="http://www.wago.com/232-140/005-000">www.wago.com/232-140/005-000</a>
	<b>Obj. č.: 232-140/005-000/039-000</b> Female connector for rail-mount terminal blocks; Rovné provedení; Blokovací západka; Rozteč 5 mm; 10pól.; Šedá	<a href="http://www.wago.com/232-140/005-000/039-000">www.wago.com/232-140/005-000/039-000</a>
	<b>Obj. č.: 232-142/005-000</b> Female connector for rail-mount terminal blocks; Rovné provedení; Rozteč 5 mm; 12pól.; Šedá	<a href="http://www.wago.com/232-142/005-000">www.wago.com/232-142/005-000</a>
	<b>Obj. č.: 232-142/005-000/039-000</b> Female connector for rail-mount terminal blocks; Rovné provedení; Blokovací západka; Rozteč 5 mm; 12pól.; Šedá	<a href="http://www.wago.com/232-142/005-000/039-000">www.wago.com/232-142/005-000/039-000</a>
	<b>Obj. č.: 232-146/005-000</b> Female connector for rail-mount terminal blocks; Rovné provedení; Rozteč 5 mm; 16pól.; Šedá	<a href="http://www.wago.com/232-146/005-000">www.wago.com/232-146/005-000</a>
	<b>Obj. č.: 232-146/005-000/039-000</b> Female connector for rail-mount terminal blocks; Rovné provedení; Blokovací západka; Rozteč 5 mm; 16pól.; Šedá	<a href="http://www.wago.com/232-146/005-000/039-000">www.wago.com/232-146/005-000/039-000</a>
	<b>Obj. č.: 232-147/005-000/039-000</b> Female connector for rail-mount terminal blocks; straight; Locking lever; Pin spacing 5 mm; 17-pole;	

	gray	<a href="http://www.wago.com/232-147/005-000/039-000">www.wago.com/232-147/005-000/039-000</a>
	<b>Obj. č.: 232-150/005-000</b> Female connector for rail-mount terminal blocks; Rovné provedení; Rozteč 5 mm; 20pól.; Šedá	<a href="http://www.wago.com/232-150/005-000">www.wago.com/232-150/005-000</a>
	<b>Obj. č.: 232-150/005-000/039-000</b> Female connector for rail-mount terminal blocks; straight; Locking lever; Pin spacing 5 mm; 20-pole; gray	<a href="http://www.wago.com/232-150/005-000/039-000">www.wago.com/232-150/005-000/039-000</a>
	<b>Obj. č.: 232-232/005-000</b> Female connector for rail-mount terminal blocks; Úhlové provedení; Rozteč 5 mm; 2pól.; Šedá	<a href="http://www.wago.com/232-232/005-000">www.wago.com/232-232/005-000</a>
	<b>Obj. č.: 232-232/005-000/039-000</b> Female connector for rail-mount terminal blocks; Úhlové provedení; Blokovací západka; Rozteč 5 mm; 2pól.; Šedá	<a href="http://www.wago.com/232-232/005-000/039-000">www.wago.com/232-232/005-000/039-000</a>
	<b>Obj. č.: 232-233/005-000</b> Female connector for rail-mount terminal blocks; Úhlové provedení; Rozteč 5 mm; 3pól.; Šedá	<a href="http://www.wago.com/232-233/005-000">www.wago.com/232-233/005-000</a>
	<b>Obj. č.: 232-233/005-000/039-000</b> Female connector for rail-mount terminal blocks; angled; Locking lever; Pin spacing 5 mm; 3-pole; gray	<a href="http://www.wago.com/232-233/005-000/039-000">www.wago.com/232-233/005-000/039-000</a>
	<b>Obj. č.: 232-234/005-000</b> Female connector for rail-mount terminal blocks; Úhlové provedení; Rozteč 5 mm; 4pól.; Šedá	<a href="http://www.wago.com/232-234/005-000">www.wago.com/232-234/005-000</a>
	<b>Obj. č.: 232-234/005-000/039-000</b> Female connector for rail-mount terminal blocks; Úhlové provedení; Blokovací západka; Rozteč 5 mm; 4pól.; Šedá	<a href="http://www.wago.com/232-234/005-000/039-000">www.wago.com/232-234/005-000/039-000</a>
	<b>Obj. č.: 232-235/005-000</b> Female connector for rail-mount terminal blocks; Úhlové provedení; Rozteč 5 mm; 5pól.; Šedá	<a href="http://www.wago.com/232-235/005-000">www.wago.com/232-235/005-000</a>
	<b>Obj. č.: 232-235/005-000/039-000</b> Female connector for rail-mount terminal blocks; Úhlové provedení; Blokovací západka; Rozteč 5 mm; 5pól.; Šedá	<a href="http://www.wago.com/232-235/005-000/039-000">www.wago.com/232-235/005-000/039-000</a>
	<b>Obj. č.: 232-236/005-000</b> Female connector for rail-mount terminal blocks; Úhlové provedení; Rozteč 5 mm; 6pól.; Šedá	<a href="http://www.wago.com/232-236/005-000">www.wago.com/232-236/005-000</a>
	<b>Obj. č.: 232-236/005-000/039-000</b> Female connector for rail-mount terminal blocks; angled; Locking lever; Pin spacing 5 mm; 6-pole; gray	<a href="http://www.wago.com/232-236/005-000/039-000">www.wago.com/232-236/005-000/039-000</a>
	<b>Obj. č.: 232-237/005-000</b> Female connector for rail-mount terminal blocks; Úhlové provedení; Rozteč 5 mm; 7pól.; Šedá	<a href="http://www.wago.com/232-237/005-000">www.wago.com/232-237/005-000</a>
	<b>Obj. č.: 232-238/005-000</b> Female connector for rail-mount terminal blocks; Úhlové provedení; Rozteč 5 mm; 8pól.; Šedá	<a href="http://www.wago.com/232-238/005-000">www.wago.com/232-238/005-000</a>



**Obj. č.: 232-239/005-000**

Female connector for rail-mount terminal blocks; Úhlové provedení; Rozteč 5 mm; 9pól.; Šedá

[www.wago.com/232-239/005-000](http://www.wago.com/232-239/005-000)**Obj. č.: 232-240/005-000**

Female connector for rail-mount terminal blocks; Úhlové provedení; Rozteč 5 mm; 10pól.; Šedá

[www.wago.com/232-240/005-000](http://www.wago.com/232-240/005-000)**Obj. č.: 232-240/005-000/039-000**

Female connector for rail-mount terminal blocks; Úhlové provedení; Blokovací západka; Rozteč 5 mm; 10pól.; Šedá

[www.wago.com/232-240/005-000/039-000](http://www.wago.com/232-240/005-000/039-000)**Obj. č.: 232-242/005-000**

Female connector for rail-mount terminal blocks; Úhlové provedení; Rozteč 5 mm; 12pól.; Šedá

[www.wago.com/232-242/005-000](http://www.wago.com/232-242/005-000)**Obj. č.: 232-242/005-000/039-000**

Female connector for rail-mount terminal blocks; Úhlové provedení; Blokovací západka; Rozteč 5 mm; 12pól.; Šedá

[www.wago.com/232-242/005-000/039-000](http://www.wago.com/232-242/005-000/039-000)**Obj. č.: 232-246/005-000**

Female connector for rail-mount terminal blocks; Úhlové provedení; Rozteč 5 mm; 16pól.; Šedá

[www.wago.com/232-246/005-000](http://www.wago.com/232-246/005-000)**Obj. č.: 232-246/005-000/039-000**

Female connector for rail-mount terminal blocks; Úhlové provedení; Blokovací západka; Rozteč 5 mm; 16pól.; Šedá

[www.wago.com/232-246/005-000/039-000](http://www.wago.com/232-246/005-000/039-000)**Obj. č.: 232-250/005-000**

Female connector for rail-mount terminal blocks; Úhlové provedení; Rozteč 5 mm; 20pól.; Šedá

[www.wago.com/232-250/005-000](http://www.wago.com/232-250/005-000)**Obj. č.: 232-250/005-000/039-000**

Female connector for rail-mount terminal blocks; angled; Locking lever; Pin spacing 5 mm; 20-pole; gray

[www.wago.com/232-250/005-000/039-000](http://www.wago.com/232-250/005-000/039-000)**Obj. č.: 232-732/005-000**

Female connector for rail-mount terminal blocks; Rovné provedení; Rozteč 7,5 mm; 2pól.; Šedá

[www.wago.com/232-732/005-000](http://www.wago.com/232-732/005-000)**Obj. č.: 232-733/005-000**

Female connector for rail-mount terminal blocks; Rovné provedení; Rozteč 7,5 mm; 3pól.; Šedá

[www.wago.com/232-733/005-000](http://www.wago.com/232-733/005-000)**Obj. č.: 232-734/005-000**

Female connector for rail-mount terminal blocks; Rovné provedení; Rozteč 7,5 mm; 4pól.; Šedá















[www.wago.com/232-734/005-000](http://www.wago.com/232-734/005-000)**Obj. č.: 232-734/005-000/039-000**

Female connector for rail-mount terminal blocks; Rovné provedení; Rozteč 7,5 mm; 4pól.; Šedá

[www.wago.com/232-734/005-000/039-000](http://www.wago.com/232-734/005-000/039-000)**Obj. č.: 232-735/005-000**

Female connector for rail-mount terminal blocks; Rovné provedení; Rozteč 7,5 mm; 5pól.; Šedá

[www.wago.com/232-735/005-000](http://www.wago.com/232-735/005-000)

	<b>Obj. č.: 232-735/005-000/039-000</b> Female connector for rail-mount terminal blocks; Rovné provedení; Rozteč 7,5 mm; 5pól.; Šedá	<a href="http://www.wago.com/232-735/005-000/039-000">www.wago.com/232-735/005-000/039-000</a>
	<b>Obj. č.: 232-736/005-000</b> Female connector for rail-mount terminal blocks; Rovné provedení; Rozteč 7,5 mm; 6pól.; Šedá	<a href="http://www.wago.com/232-736/005-000">www.wago.com/232-736/005-000</a>
	<b>Obj. č.: 232-736/005-000/039-000</b> Female connector for rail-mount terminal blocks; Rovné provedení; Rozteč 7,5 mm; 6pól.; Šedá	<a href="http://www.wago.com/232-736/005-000/039-000">www.wago.com/232-736/005-000/039-000</a>
	<b>Obj. č.: 232-738/005-000</b> Female connector for rail-mount terminal blocks; Rovné provedení; Rozteč 7,5 mm; 8pól.; Šedá	<a href="http://www.wago.com/232-738/005-000">www.wago.com/232-738/005-000</a>
	<b>Obj. č.: 232-740/005-000</b> Female connector for rail-mount terminal blocks; Rovné provedení; Rozteč 7,5 mm; 10pól.; Šedá	<a href="http://www.wago.com/232-740/005-000">www.wago.com/232-740/005-000</a>
	<b>Obj. č.: 232-742/005-000</b> Female connector for rail-mount terminal blocks; Rovné provedení; Rozteč 7,5 mm; 12pól.; Šedá	<a href="http://www.wago.com/232-742/005-000">www.wago.com/232-742/005-000</a>
	<b>Obj. č.: 232-832/005-000</b> Pružinová svorkovnice THT; 0.6 x 1.0 mm solder pin; Úhlové provedení; Rozteč 7,5 mm; 2pól.; Šedá	<a href="http://www.wago.com/232-832/005-000">www.wago.com/232-832/005-000</a>
	<b>Obj. č.: 232-833/005-000</b> Pružinová svorkovnice THT; 0.6 x 1.0 mm solder pin; Úhlové provedení; Rozteč 7,5 mm; 3pól.; Šedá	<a href="http://www.wago.com/232-833/005-000">www.wago.com/232-833/005-000</a>
	<b>Obj. č.: 232-834/005-000</b> Pružinová svorkovnice THT; 0.6 x 1.0 mm solder pin; Úhlové provedení; Rozteč 7,5 mm; 4pól.; Šedá	<a href="http://www.wago.com/232-834/005-000">www.wago.com/232-834/005-000</a>
	<b>Obj. č.: 232-836/005-000</b> Pružinová svorkovnice THT; 0.6 x 1.0 mm solder pin; Úhlové provedení; Rozteč 7,5 mm; 6pól.; Šedá	<a href="http://www.wago.com/232-836/005-000">www.wago.com/232-836/005-000</a>
	<b>Obj. č.: 232-836/005-000/039-000</b> Pružinová svorkovnice THT; 0.6 x 1.0 mm solder pin; Úhlové provedení; Blokovací západka; Rozteč 7,5 mm; 6pól.; Šedá	<a href="http://www.wago.com/232-836/005-000/039-000">www.wago.com/232-836/005-000/039-000</a>
	<b>Obj. č.: 232-840/005-000</b> Pružinová svorkovnice THT; 0.6 x 1.0 mm solder pin; Úhlové provedení; Rozteč 7,5 mm; 10pól.; Šedá	<a href="http://www.wago.com/232-840/005-000">www.wago.com/232-840/005-000</a>
	<b>Obj. č.: 232-842/005-000</b> THT female header; 0.6 x 1.0 mm solder pin; angled; Pin spacing 7.5 mm; 12-pole; gray	<a href="http://www.wago.com/232-842/005-000">www.wago.com/232-842/005-000</a>
	<b>Obj. č.: 722-132/005-000</b> Female connector for rail-mount terminal blocks; Rovné provedení; 100% ochrana proti chybnému zapojení; Rozteč 5 mm; 2pól.; Světle šedá	<a href="http://www.wago.com/722-132/005-000">www.wago.com/722-132/005-000</a>
	<b>Obj. č.: 722-132/005-000/039-000</b> Female connector for rail-mount terminal blocks; Rovné provedení; 100% ochrana proti chybnému	<a href="http://www.wago.com/722-132/005-000/039-000">www.wago.com/722-132/005-000/039-000</a>

zapojení; Blokovací západka; Rozteč 5 mm; 3pól.; Světle šedá

**Obj. č.: 722-133/005-000**

Female connector for rail-mount terminal blocks; Rovné provedení; 100% ochrana proti chybnému zapojení; Rozteč 5 mm; 3pól.; Světle šedá

[www.wago.com/722-133/005-000](http://www.wago.com/722-133/005-000)**Obj. č.: 722-133/005-000/039-000**

Female connector for rail-mount terminal blocks; Rovné provedení; 100% ochrana proti chybnému zapojení; Blokovací západka; Rozteč 5 mm; 3pól.; Světle šedá

[www.wago.com/722-133/005-000/039-000](http://www.wago.com/722-133/005-000/039-000)**Obj. č.: 722-134/005-000**

Female connector for rail-mount terminal blocks; Rovné provedení; 100% ochrana proti chybnému zapojení; Rozteč 5 mm; 4pól.; Světle šedá

[www.wago.com/722-134/005-000](http://www.wago.com/722-134/005-000)**Obj. č.: 722-134/005-000/039-000**

Female connector for rail-mount terminal blocks; Rovné provedení; 100% ochrana proti chybnému zapojení; Blokovací západka; Rozteč 5 mm; 4pól.; Světle šedá

[www.wago.com/722-134/005-000/039-000](http://www.wago.com/722-134/005-000/039-000)**Obj. č.: 722-135/005-000**

Female connector for rail-mount terminal blocks; Rovné provedení; 100% ochrana proti chybnému zapojení; Rozteč 5 mm; 5pól.; Světle šedá

[www.wago.com/722-135/005-000](http://www.wago.com/722-135/005-000)**Obj. č.: 722-135/005-000/039-000**

Female connector for rail-mount terminal blocks; Rovné provedení; 100% ochrana proti chybnému zapojení; Blokovací západka; Rozteč 5 mm; 5pól.; Světle šedá

[www.wago.com/722-135/005-000/039-000](http://www.wago.com/722-135/005-000/039-000)**Obj. č.: 722-136/005-000**

Female connector for rail-mount terminal blocks; Rovné provedení; 100% ochrana proti chybnému zapojení; Rozteč 5 mm; 6pól.; Světle šedá

[www.wago.com/722-136/005-000](http://www.wago.com/722-136/005-000)**Obj. č.: 722-136/005-000/039-000**

Female connector for rail-mount terminal blocks; Rovné provedení; 100% ochrana proti chybnému zapojení; Blokovací západka; Rozteč 5 mm; 6pól.; Světle šedá

[www.wago.com/722-136/005-000/039-000](http://www.wago.com/722-136/005-000/039-000)**Obj. č.: 722-137/005-000**

Female connector for rail-mount terminal blocks; Rovné provedení; 100% ochrana proti chybnému zapojení; Rozteč 5 mm; 7pól.; Světle šedá

[www.wago.com/722-137/005-000](http://www.wago.com/722-137/005-000)**Obj. č.: 722-137/005-000/039-000**

Female connector for rail-mount terminal blocks; Rovné provedení; 100% ochrana proti chybnému zapojení; Blokovací západka; Rozteč 5 mm; 7pól.; Světle šedá

[www.wago.com/722-137/005-000/039-000](http://www.wago.com/722-137/005-000/039-000)**Obj. č.: 722-138/005-000**

Female connector for rail-mount terminal blocks; Rovné provedení; 100% ochrana proti chybnému zapojení; Rozteč 5 mm; 8pól.; Světle šedá

[www.wago.com/722-138/005-000](http://www.wago.com/722-138/005-000)**Obj. č.: 722-138/005-000/039-000**

Female connector for rail-mount terminal blocks; Rovné provedení; 100% ochrana proti chybnému zapojení; Blokovací západka; Rozteč 5 mm; 8pól.; Světle šedá















[www.wago.com/722-138/005-000/039-000](http://www.wago.com/722-138/005-000/039-000)**Obj. č.: 722-139/005-000**















Female connector for rail-mount terminal blocks; Rovné provedení; 100% ochrana proti chybnému zapojení; Rozteč 5 mm; 9pól.; Světle šedá

[www.wago.com/722-139/005-000](http://www.wago.com/722-139/005-000)**Obj. č.: 722-139/005-000/039-000**



Female connector for rail-mount terminal blocks; Rovné provedení; 100% ochrana proti chybnému zapojení; Blokovací západka; Rozteč 5 mm; 9pól.; Světle šedá

[www.wago.com/722-139/005-000/039-000](http://www.wago.com/722-139/005-000/039-000)**Obj. č.: 722-140/005-000**





	Female connector for rail-mount terminal blocks; Rovné provedení; 100% ochrana proti chybnému zapojení; Rozteč 5 mm; 10pól.; Světle šedá	<a href="http://www.wago.com/722-140/005-000">www.wago.com/722-140/005-000</a>
	<b>Obj. č.: 722-140/005-000/039-000</b> Female connector for rail-mount terminal blocks; Rovné provedení; 100% ochrana proti chybnému zapojení; Blokovací západka; Rozteč 5 mm; 10pól.; Světle šedá	<a href="http://www.wago.com/722-140/005-000/039-000">www.wago.com/722-140/005-000/039-000</a>
	<b>Obj. č.: 722-141/005-000</b> Female connector for rail-mount terminal blocks; Rovné provedení; 100% ochrana proti chybnému zapojení; Rozteč 5 mm; 11pól.; Světle šedá	<a href="http://www.wago.com/722-141/005-000">www.wago.com/722-141/005-000</a>
	<b>Obj. č.: 722-142/005-000</b> Female connector for rail-mount terminal blocks; Rovné provedení; 100% ochrana proti chybnému zapojení; Rozteč 5 mm; 12pól.; Světle šedá	<a href="http://www.wago.com/722-142/005-000">www.wago.com/722-142/005-000</a>
	<b>Obj. č.: 722-142/005-007/039-000</b> Female connector for rail-mount terminal blocks; Šedá	<a href="http://www.wago.com/722-142/005-007/039-000">www.wago.com/722-142/005-007/039-000</a>
	<b>Obj. č.: 722-143/005-000</b> Female connector for rail-mount terminal blocks; Rovné provedení; 100% ochrana proti chybnému zapojení; Rozteč 5 mm; 13pól.; Světle šedá	<a href="http://www.wago.com/722-143/005-000">www.wago.com/722-143/005-000</a>
	<b>Obj. č.: 722-144/005-000</b> Female connector for rail-mount terminal blocks; straight; 100% protected against mismatching; Pin spacing 5 mm; 14-pole; light gray	<a href="http://www.wago.com/722-144/005-000">www.wago.com/722-144/005-000</a>
	<b>Obj. č.: 722-144/005-000/039-000</b> Female connector for rail-mount terminal blocks; Rovné provedení; 100% ochrana proti chybnému zapojení; Blokovací západka; Rozteč 5 mm; 14pól.; Světle šedá	<a href="http://www.wago.com/722-144/005-000/039-000">www.wago.com/722-144/005-000/039-000</a>
	<b>Obj. č.: 722-145/005-000</b> Female connector for rail-mount terminal blocks; Rovné provedení; 100% ochrana proti chybnému zapojení; Rozteč 5 mm; 15pól.; Světle šedá	<a href="http://www.wago.com/722-145/005-000">www.wago.com/722-145/005-000</a>
	<b>Obj. č.: 722-146/005-000</b> Female connector for rail-mount terminal blocks; Rovné provedení; 100% ochrana proti chybnému zapojení; Rozteč 5 mm; 16pól.; Světle šedá	<a href="http://www.wago.com/722-146/005-000">www.wago.com/722-146/005-000</a>
	<b>Obj. č.: 722-146/005-000/039-000</b> Female connector for rail-mount terminal blocks; straight; 100% protected against mismatching; Locking lever; Pin spacing 5 mm; 16-pole; light gray	<a href="http://www.wago.com/722-146/005-000/039-000">www.wago.com/722-146/005-000/039-000</a>
	<b>Obj. č.: 722-150/005-000</b> Female connector for rail-mount terminal blocks; Rovné provedení; 100% ochrana proti chybnému zapojení; Rozteč 5 mm; 20pól.; Světle šedá	<a href="http://www.wago.com/722-150/005-000">www.wago.com/722-150/005-000</a>
	<b>Obj. č.: 722-150/005-000/039-000</b> Female connector for rail-mount terminal blocks; Rovné provedení; 100% ochrana proti chybnému zapojení; Blokovací západka; Rozteč 5 mm; 20pól.; Světle šedá	<a href="http://www.wago.com/722-150/005-000/039-000">www.wago.com/722-150/005-000/039-000</a>
	<b>Obj. č.: 722-232/005-000</b> Female connector for rail-mount terminal blocks; Úhlové provedení; 100% ochrana proti chybnému zapojení; Rozteč 5 mm; 3pól.; Světle šedá	<a href="http://www.wago.com/722-232/005-000">www.wago.com/722-232/005-000</a>
	<b>Obj. č.: 722-232/005-000/039-000</b> Female connector for rail-mount terminal blocks; Úhlové provedení; 100% ochrana proti chybnému zapojení; Blokovací západka; Rozteč 5 mm; 3pól.; Světle šedá	<a href="http://www.wago.com/722-232/005-000/039-000">www.wago.com/722-232/005-000/039-000</a>















	<b>Obj. č.: 722-233/005-000</b> Female connector for rail-mount terminal blocks; Úhlové provedení; 100% ochrana proti chybnému zapojení; Rozteč 5 mm; 3pól.; Světle šedá	<a href="http://www.wago.com/722-233/005-000">www.wago.com/722-233/005-000</a>
	<b>Obj. č.: 722-233/005-000/039-000</b> Female connector for rail-mount terminal blocks; Úhlové provedení; 100% ochrana proti chybnému zapojení; Blokovací západka; Rozteč 5 mm; 3pól.; Světle šedá	<a href="http://www.wago.com/722-233/005-000/039-000">www.wago.com/722-233/005-000/039-000</a>
	<b>Obj. č.: 722-234/005-000</b> Female connector for rail-mount terminal blocks; Úhlové provedení; 100% ochrana proti chybnému zapojení; Rozteč 5 mm; 4pól.; Světle šedá	<a href="http://www.wago.com/722-234/005-000">www.wago.com/722-234/005-000</a>
	<b>Obj. č.: 722-234/005-000/039-000</b> Female connector for rail-mount terminal blocks; Úhlové provedení; 100% ochrana proti chybnému zapojení; Blokovací západka; Rozteč 5 mm; 4pól.; Světle šedá	<a href="http://www.wago.com/722-234/005-000/039-000">www.wago.com/722-234/005-000/039-000</a>
	<b>Obj. č.: 722-235/005-000</b> Female connector for rail-mount terminal blocks; Úhlové provedení; 100% ochrana proti chybnému zapojení; Rozteč 5 mm; 5pól.; Světle šedá	<a href="http://www.wago.com/722-235/005-000">www.wago.com/722-235/005-000</a>
	<b>Obj. č.: 722-235/005-000/039-000</b> Female connector for rail-mount terminal blocks; Úhlové provedení; 100% ochrana proti chybnému zapojení; Blokovací západka; Rozteč 5 mm; 5pól.; Světle šedá	<a href="http://www.wago.com/722-235/005-000/039-000">www.wago.com/722-235/005-000/039-000</a>
	<b>Obj. č.: 722-236/005-000</b> Female connector for rail-mount terminal blocks; Úhlové provedení; 100% ochrana proti chybnému zapojení; Rozteč 5 mm; 6pól.; Světle šedá	<a href="http://www.wago.com/722-236/005-000">www.wago.com/722-236/005-000</a>
	<b>Obj. č.: 722-236/005-000/039-000</b> Female connector for rail-mount terminal blocks; Úhlové provedení; 100% ochrana proti chybnému zapojení; Blokovací západka; Rozteč 5 mm; 6pól.; Světle šedá	<a href="http://www.wago.com/722-236/005-000/039-000">www.wago.com/722-236/005-000/039-000</a>
	<b>Obj. č.: 722-237/005-000</b> Female connector for rail-mount terminal blocks; Úhlové provedení; 100% ochrana proti chybnému zapojení; Rozteč 5 mm; 7pól.; Světle šedá	<a href="http://www.wago.com/722-237/005-000">www.wago.com/722-237/005-000</a>
	<b>Obj. č.: 722-237/005-000/039-000</b> Female connector for rail-mount terminal blocks; Úhlové provedení; 100% ochrana proti chybnému zapojení; Blokovací západka; Rozteč 5 mm; 7pól.; Světle šedá	<a href="http://www.wago.com/722-237/005-000/039-000">www.wago.com/722-237/005-000/039-000</a>
	<b>Obj. č.: 722-238/005-000</b> Female connector for rail-mount terminal blocks; Úhlové provedení; 100% ochrana proti chybnému zapojení; Rozteč 5 mm; 8pól.; Světle šedá	<a href="http://www.wago.com/722-238/005-000">www.wago.com/722-238/005-000</a>
	<b>Obj. č.: 722-239/005-000</b> Female connector for rail-mount terminal blocks; Úhlové provedení; 100% ochrana proti chybnému zapojení; Rozteč 5 mm; 9pól.; Světle šedá	<a href="http://www.wago.com/722-239/005-000">www.wago.com/722-239/005-000</a>
	<b>Obj. č.: 722-239/005-000/039-000</b> Female connector for rail-mount terminal blocks; angled; 100% protected against mismatching; Locking lever; Pin spacing 5 mm; 9-pole; light gray	<a href="http://www.wago.com/722-239/005-000/039-000">www.wago.com/722-239/005-000/039-000</a>
	<b>Obj. č.: 722-240/005-000</b> Female connector for rail-mount terminal blocks; Úhlové provedení; 100% ochrana proti chybnému zapojení; Rozteč 5 mm; 10pól.; Světle šedá	<a href="http://www.wago.com/722-240/005-000">www.wago.com/722-240/005-000</a>

Obj. č.: 722-240/005-000/039-000

	Female connector for rail-mount terminal blocks; Úhlové provedení; 100% ochrana proti chybnému zapojení; Blokovací západka; Rozteč 5 mm; 10pól.; Světle šedá	<a href="http://www.wago.com/722-240/005-000/039-000">www.wago.com/722-240/005-000/039-000</a>
	<b>Obj. č.: 722-241/005-000</b> Female connector for rail-mount terminal blocks; Úhlové provedení; 100% ochrana proti chybnému zapojení; Rozteč 5 mm; 11pól.; Světle šedá	<a href="http://www.wago.com/722-241/005-000">www.wago.com/722-241/005-000</a>
	<b>Obj. č.: 722-242/005-000</b> Female connector for rail-mount terminal blocks; Úhlové provedení; 100% ochrana proti chybnému zapojení; Rozteč 5 mm; 12pól.; Světle šedá	<a href="http://www.wago.com/722-242/005-000">www.wago.com/722-242/005-000</a>
	<b>Obj. č.: 722-242/005-000/039-000</b> Female connector for rail-mount terminal blocks; angled; 100% protected against mismating; Locking lever; Pin spacing 5 mm; 12-pole; light gray	<a href="http://www.wago.com/722-242/005-000/039-000">www.wago.com/722-242/005-000/039-000</a>
	<b>Obj. č.: 722-243/005-000</b> Female connector for rail-mount terminal blocks; angled; 100% protected against mismating; Pin spacing 5 mm; 13-pole; light gray	<a href="http://www.wago.com/722-243/005-000">www.wago.com/722-243/005-000</a>
	<b>Obj. č.: 722-244/005-000</b> Female connector for rail-mount terminal blocks; Úhlové provedení; 100% ochrana proti chybnému zapojení; Rozteč 5 mm; 14pól.; Světle šedá	<a href="http://www.wago.com/722-244/005-000">www.wago.com/722-244/005-000</a>
	<b>Obj. č.: 722-244/005-000/039-000</b> Female connector for rail-mount terminal blocks; Úhlové provedení; 100% ochrana proti chybnému zapojení; Blokovací západka; Rozteč 5 mm; 14pól.; Světle šedá	<a href="http://www.wago.com/722-244/005-000/039-000">www.wago.com/722-244/005-000/039-000</a>
	<b>Obj. č.: 722-246/005-000</b> Female connector for rail-mount terminal blocks; Úhlové provedení; 100% ochrana proti chybnému zapojení; Rozteč 5 mm; 16pól.; Světle šedá	<a href="http://www.wago.com/722-246/005-000">www.wago.com/722-246/005-000</a>
	<b>Obj. č.: 722-246/005-000/039-000</b> Female connector for rail-mount terminal blocks; Úhlové provedení; 100% ochrana proti chybnému zapojení; Blokovací západka; Rozteč 5 mm; 16pól.; Světle šedá	<a href="http://www.wago.com/722-246/005-000/039-000">www.wago.com/722-246/005-000/039-000</a>
	<b>Obj. č.: 722-250/005-000</b> Female connector for rail-mount terminal blocks; Úhlové provedení; 100% ochrana proti chybnému zapojení; Rozteč 5 mm; 20pól.; Světle šedá	<a href="http://www.wago.com/722-250/005-000">www.wago.com/722-250/005-000</a>

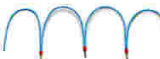
## General accessories

	<b>Obj. č.: 231-162/003-000</b> Male connector for rail-mount terminal blocks; 1.2 x 1.2 mm pins; Rovné provedení; Rozteč 5 mm; 2pól.; Šedá	<a href="http://www.wago.com/231-162/003-000">www.wago.com/231-162/003-000</a>
	<b>Obj. č.: 231-163/003-000</b> Male connector for rail-mount terminal blocks; 1.2 x 1.2 mm pins; Rovné provedení; Rozteč 5 mm; 3pól.; Šedá	<a href="http://www.wago.com/231-163/003-000">www.wago.com/231-163/003-000</a>
	<b>Obj. č.: 231-164/003-000</b> Male connector for rail-mount terminal blocks; 1.2 x 1.2 mm pins; Rovné provedení; Rozteč 5 mm; 4pól.; Šedá	<a href="http://www.wago.com/231-164/003-000">www.wago.com/231-164/003-000</a>
	<b>Obj. č.: 231-165/003-000</b> Male connector for rail-mount terminal blocks; 1.2 x 1.2 mm pins; Rovné provedení; Rozteč 5 mm; 5pól.; Šedá	<a href="http://www.wago.com/231-165/003-000">www.wago.com/231-165/003-000</a>
	<b>Obj. č.: 231-166/003-000</b>	

	Male connector for rail-mount terminal blocks; 1.2 x 1.2 mm pins; Rovné provedení; Rozteč 5 mm; 6pól.; Šedá	<a href="http://www.wago.com/231-166/003-000">www.wago.com/231-166/003-000</a>
	<b>Obj. č.: 231-167/003-000</b> Male connector for rail-mount terminal blocks; 1.2 x 1.2 mm pins; Rovné provedení; Rozteč 5 mm; 7pól.; Šedá	<a href="http://www.wago.com/231-167/003-000">www.wago.com/231-167/003-000</a>
	<b>Obj. č.: 231-168/003-000</b> Male connector for rail-mount terminal blocks; 1.2 x 1.2 mm pins; Rovné provedení; Rozteč 5 mm; 8pól.; Šedá	<a href="http://www.wago.com/231-168/003-000">www.wago.com/231-168/003-000</a>
	<b>Obj. č.: 231-169/003-000</b> Male connector for rail-mount terminal blocks; 1.2 x 1.2 mm pins; Rovné provedení; Rozteč 5 mm; 9pól.; Šedá	<a href="http://www.wago.com/231-169/003-000">www.wago.com/231-169/003-000</a>
	<b>Obj. č.: 231-170/003-000</b> Male connector for rail-mount terminal blocks; 1.2 x 1.2 mm pins; Rovné provedení; Rozteč 5 mm; 10pól.; Šedá	<a href="http://www.wago.com/231-170/003-000">www.wago.com/231-170/003-000</a>
	<b>Obj. č.: 231-171/003-000</b> Male connector for rail-mount terminal blocks; 1.2 x 1.2 mm pins; Rovné provedení; Rozteč 5 mm; 11pól.; Šedá	<a href="http://www.wago.com/231-171/003-000">www.wago.com/231-171/003-000</a>
	<b>Obj. č.: 231-172/003-000</b> Male connector for rail-mount terminal blocks; 1.2 x 1.2 mm pins; Rovné provedení; Rozteč 5 mm; 12pól.; Šedá	<a href="http://www.wago.com/231-172/003-000">www.wago.com/231-172/003-000</a>
	<b>Obj. č.: 231-176/003-000</b> Male connector for rail-mount terminal blocks; 1.2 x 1.2 mm pins; Rovné provedení; Rozteč 5 mm; 16pól.; Šedá	<a href="http://www.wago.com/231-176/003-000">www.wago.com/231-176/003-000</a>
	<b>Obj. č.: 231-180/003-000</b> Male connector for rail-mount terminal blocks; 1.2 x 1.2 mm pins; Rovné provedení; Rozteč 5 mm; 20pól.; Šedá	<a href="http://www.wago.com/231-180/003-000">www.wago.com/231-180/003-000</a>
	<b>Obj. č.: 709-170</b> Blokovací pojistka proti zapojení; Pro rozpojovací vidlice rozpojovacích svorek řad 280/281 a 769; Červená	<a href="http://www.wago.com/709-170">www.wago.com/709-170</a>
<b>Jumper</b>		
	<b>Obj. č.: 210-103</b> Vícenásobný vodičový můstek; Izolováno; 50 přípojek; Černá	<a href="http://www.wago.com/210-103">www.wago.com/210-103</a>
	<b>Obj. č.: 210-123</b> Vícenásobný vodičový můstek; Izolováno; 50 přípojek	<a href="http://www.wago.com/210-123">www.wago.com/210-123</a>
	<b>Obj. č.: 280-482</b> Hřebenový můstek; Izolováno; 2x; IN = IN svorky; Šedá	<a href="http://www.wago.com/280-482">www.wago.com/280-482</a>
	<b>Obj. č.: 280-483</b> Hřebenový můstek; Izolováno; 3x; IN = IN svorky; Šedá	<a href="http://www.wago.com/280-483">www.wago.com/280-483</a>
	<b>Obj. č.: 280-484</b> Hřebenový můstek; Izolováno; 4x; IN = IN svorky; Šedá	<a href="http://www.wago.com/280-484">www.wago.com/280-484</a>
	<b>Obj. č.: 280-485</b> Hřebenový můstek; Izolováno; 5x; IN = IN svorky; Šedá	<a href="http://www.wago.com/280-485">www.wago.com/280-485</a>



**Obj. č.: 280-490**  
Hřebenový můstek; Izolováno; 10x; IN = IN svorky; Šedá

[www.wago.com/280-490](http://www.wago.com/280-490)



**Obj. č.: 280-492**  
Hřebenový můstek ob svorku; Izolováno; 2x; IN = IN svorky; Šedá

[www.wago.com/280-492](http://www.wago.com/280-492)



**Obj. č.: 709-110**  
Vícenásobný vodičový můstek; Izolováno; 4 přípojk; 3 × 110 mm; Černá

[www.wago.com/709-110](http://www.wago.com/709-110)



**Obj. č.: 709-111**  
Vícenásobný vodičový můstek; Izolováno; 3 přípojek; 2 × 120 mm; Černá

[www.wago.com/709-111](http://www.wago.com/709-111)



**Obj. č.: 709-112**  
Vícenásobný vodičový můstek; Izolováno; 3 přípojek; 2 × 170 mm; Černá

[www.wago.com/709-112](http://www.wago.com/709-112)

#### Marking accessories



**Obj. č.: 2009-115**  
WMB Inline; Pro Smart Printer; Na cívce; Flexibilní, 5–5,2 mm; Bez potisku; Možnost naklapnutí; Bílá

[www.wago.com/2009-115](http://www.wago.com/2009-115)



**Obj. č.: 2009-115/000-002**  
WMB Inline; Pro Smart Printer; Na cívce; Flexibilní, 5–5,2 mm; Bez potisku; Možnost naklapnutí; Žlutá

[www.wago.com/2009-115/000-002](http://www.wago.com/2009-115/000-002)



**Obj. č.: 2009-115/000-006**  
WMB Inline; Pro Smart Printer; Na cívce; Flexibilní, 5–5,2 mm; Bez potisku; Možnost naklapnutí; Modrá

[www.wago.com/2009-115/000-006](http://www.wago.com/2009-115/000-006)



**Obj. č.: 2009-115/000-007**  
WMB Inline; Pro Smart Printer; Na cívce; Flexibilní, 5–5,2 mm; Bez potisku; Možnost naklapnutí; Šedá

[www.wago.com/2009-115/000-007](http://www.wago.com/2009-115/000-007)



**Obj. č.: 2009-115/000-012**  
WMB Inline; Pro Smart Printer; Na cívce; Flexibilní, 5–5,2 mm; Bez potisku; Možnost naklapnutí; Oranžová

[www.wago.com/2009-115/000-012](http://www.wago.com/2009-115/000-012)



**Obj. č.: 2009-115/000-017**  
WMB Inline; Pro Smart Printer; Na cívce; Flexibilní, 5–5,2 mm; Bez potisku; Možnost naklapnutí; Světle zelená

[www.wago.com/2009-115/000-017](http://www.wago.com/2009-115/000-017)



**Obj. č.: 2009-115/000-023**  
WMB Inline; Pro Smart Printer; Na cívce; Flexibilní, 5–5,2 mm; Bez potisku; Možnost naklapnutí; Zelená

[www.wago.com/2009-115/000-023](http://www.wago.com/2009-115/000-023)



**Obj. č.: 2009-115/000-024**  
WMB Inline; Pro Smart Printer; Na cívce; Flexibilní, 5–5,2 mm; Bez potisku; Možnost naklapnutí; Fialová

[www.wago.com/2009-115/000-024](http://www.wago.com/2009-115/000-024)



**Obj. č.: 793-501**  
Popisovací karta WMB; Jako karta; Neflexibilní; Bez potisku; Možnost naklapnutí; Bílá

[www.wago.com/793-501](http://www.wago.com/793-501)



**Obj. č.: 793-501/000-002**  
Popisovací karta WMB; Jako karta; Neflexibilní; Bez potisku; Možnost naklapnutí; Bílá

[www.wago.com/793-501/000-002](http://www.wago.com/793-501/000-002)



**Obj. č.: 793-501/000-005**  
Popisovací karta WMB; Jako karta; Neflexibilní; Bez potisku; Možnost naklapnutí; Červená

[www.wago.com/793-501/000-005](http://www.wago.com/793-501/000-005)





**Obj. č.: 793-501/000-006**  
Popisovací karta WMB; Jako karta; Neflexibilní; Bez potisku; Možnost naklapnutí; Modrá

[www.wago.com/793-501/000-006](http://www.wago.com/793-501/000-006)



**Obj. č.: 793-501/000-007**  
Popisovací karta WMB; Jako karta; Neflexibilní; Bez potisku; Možnost naklapnutí; Šedá

[www.wago.com/793-501/000-007](http://www.wago.com/793-501/000-007)



**Obj. č.: 793-501/000-012**  
Popisovací karta WMB; Jako karta; Neflexibilní; Bez potisku; Možnost naklapnutí; Oranžová

[www.wago.com/793-501/000-012](http://www.wago.com/793-501/000-012)



**Obj. č.: 793-501/000-017**  
Popisovací karta WMB; Jako karta; Neflexibilní; Bez potisku; Možnost naklapnutí; Světle zelená

[www.wago.com/793-501/000-017](http://www.wago.com/793-501/000-017)



**Obj. č.: 793-501/000-023**  
Popisovací karta WMB; Jako karta; Neflexibilní; Bez potisku; Možnost naklapnutí; Zelená

[www.wago.com/793-501/000-023](http://www.wago.com/793-501/000-023)



**Obj. č.: 793-501/000-024**  
Popisovací karta WMB; Jako karta; Neflexibilní; Bez potisku; Možnost naklapnutí; Fialová

[www.wago.com/793-501/000-024](http://www.wago.com/793-501/000-024)



**Obj. č.: 793-5501**  
Popisovací karta WMB; Jako karta; Pro svorky o šířce 5–17,5 mm; Flexibilní, 5–5,2 mm; Bez potisku; Možnost naklapnutí; Bílá

[www.wago.com/793-5501](http://www.wago.com/793-5501)



**Obj. č.: 793-5501/000-002**  
Popisovací karta WMB; Jako karta; Pro svorky o šířce 5–17,5 mm; Flexibilní, 5–5,2 mm; Bez potisku; Možnost naklapnutí; Žlutá

[www.wago.com/793-5501/000-002](http://www.wago.com/793-5501/000-002)



**Obj. č.: 793-5501/000-005**  
Popisovací karta WMB; Jako karta; Flexibilní, 5–5,2 mm; Bez potisku; Možnost naklapnutí; Červená

[www.wago.com/793-5501/000-005](http://www.wago.com/793-5501/000-005)



**Obj. č.: 793-5501/000-006**  
Popisovací karta WMB; Jako karta; Flexibilní, 5–5,2 mm; Bez potisku; Možnost naklapnutí; Modrá

[www.wago.com/793-5501/000-006](http://www.wago.com/793-5501/000-006)



**Obj. č.: 793-5501/000-007**  
Popisovací karta WMB; Jako karta; Flexibilní, 5–5,2 mm; Bez potisku; Možnost naklapnutí; Šedá

[www.wago.com/793-5501/000-007](http://www.wago.com/793-5501/000-007)



**Obj. č.: 793-5501/000-012**  
Popisovací karta WMB; Jako karta; Flexibilní, 5–5,2 mm; Bez potisku; Možnost naklapnutí; Oranžová

[www.wago.com/793-5501/000-012](http://www.wago.com/793-5501/000-012)



**Obj. č.: 793-5501/000-017**  
Popisovací karta WMB; Jako karta; Flexibilní, 5–5,2 mm; Bez potisku; Možnost naklapnutí; Světle zelená

[www.wago.com/793-5501/000-017](http://www.wago.com/793-5501/000-017)



**Obj. č.: 793-5501/000-023**  
Popisovací karta WMB; Jako karta; Flexibilní, 5–5,2 mm; Bez potisku; Možnost naklapnutí; Zelená

[www.wago.com/793-5501/000-023](http://www.wago.com/793-5501/000-023)



**Obj. č.: 793-5501/000-024**  
Popisovací karta WMB; Jako karta; Flexibilní, 5–5,2 mm; Bez potisku; Možnost naklapnutí; Fialová

[www.wago.com/793-5501/000-024](http://www.wago.com/793-5501/000-024)

## assembling



Obj. č.: 209-106  
Držák; K izolované montáži nosných lišt DIN 35; Šedá

[www.wago.com/209-106](http://www.wago.com/209-106)



Obj. č.: 210-148  
Úchytka pro šikmou montáž; Bez šroubu

[www.wago.com/210-148](http://www.wago.com/210-148)



Obj. č.: 709-153  
Krycí profil; Typ 1; Vhodný pro držák krycího profilu typu 1; Délka 1 m; Transparentní

[www.wago.com/709-153](http://www.wago.com/709-153)

## Ke stažení

### Documentation

#### Additional Information

Technical explanations	03-Apr-2019	pdf 2,1 MB	Stáhnout
------------------------	-------------	---------------	----------

## CAD/CAE-Data

### CAD data

2D/3D Models 280-612	URL	Stáhnout
----------------------	-----	----------

### CAE data

EPLAN Data Portal 280-612	Stáhnout
---------------------------	----------

WSCAD Universe 280-612	Stáhnout
------------------------	----------

## Handling Instructions

### Safety

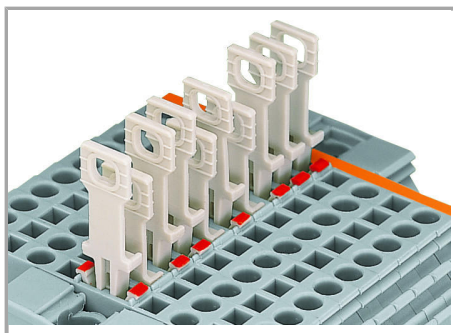

Disconnect terminal block with colored tab to indicate the switching status (red = disconnected).

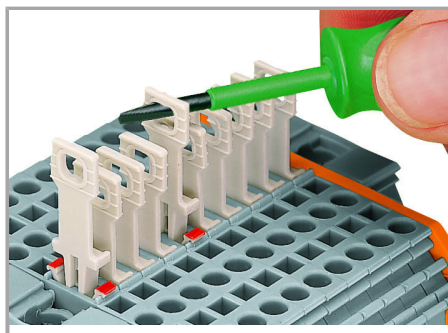

Pulling the disconnect tab via operating tool.

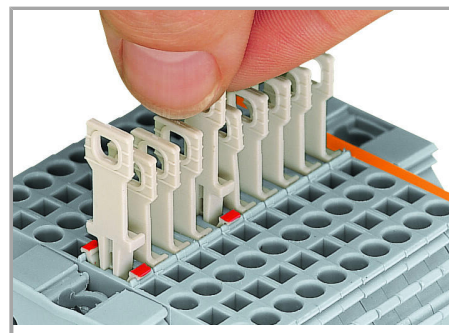

Pulling the disconnect tab by hand.

WAGO Elektro spol. sr. o.  
Rozvodova 1116/36  
143 00 Praha 12 - Modřany  
Tel.: +420 261 090 143  
Email: [info.cz@wago.com](mailto:info.cz@wago.com), [wago-cz@wago.com](mailto:wago-cz@wago.com)

Máte otázky ohledně našich produktů?  
Kdykoli nám zavolejte na číslo +420 261 090 143.