

### Popis položky

- Vhodný pro kabelovou příchytku
- 1 × výstup pro kabel vzadu

### Data

#### Elektrické parametry

#### Ratings per IEC/EN 60664-1

Legenda (návrhové hodnoty)

(III / 2) ≙ kategorie přepětí III / stupeň znečištění 2

### Údaje o připojení

Počet pólů	5
Počet typů připojení	1

### Geometrické údaje

Rozteč	5 mm / 0.197 inch
Šířka	28 mm / 1.102 inch

Výška	17,5 mm / 0.689 inch
Hloubka	41,5 mm / 1.634 inch

### Mechanické parametry

Suitable	für Stift- und Federleisten mit Leiteranschluss
----------	---

### Údaje o materiálu



barva	šedá
Požární zatížení	0.202 MJ
Hmotnost	6.72 g

### Obchodní údaje

Product Group	3 (Multi Conn. System)
Druh balení	BOX
Country of origin	DE
GTIN	4017332283045
Customs Tariff No.	85389099990

### Atesty/certifikáty

#### Specifické atesty jednotlivých států

Logo	Schválení	Doplňkový text schválení	Název certifikátu
	CSA DEKRA Certification B.V.	C22.2	1466354
	KEMA/KEUR DEKRA Certification B.V.	EN 61984	2190761.01

#### Atesty pro použití v lodním průmyslu

Logo	Schválení	Doplňkový text schválení	Název certifikátu
	ABS American Bureau of Shipping	-	19- HG15869876- PDA

#### Atesty UL

Logo	Schválení	Doplňkový text schválení	Název certifikátu
	UL Underwriters Laboratories Inc.	UL 1059	E45172- 19911118



UR

UL 1977



E45171











UL International Germany GmbH















## Kompatibilní produkty

### General accessories

	<b>Obj. č.: 209-173</b> Upevňovací šroub; Pro kabelovou příchytku; Od 7pól. provedení	<a href="http://www.wago.com/209-173">www.wago.com/209-173</a>
	<b>Obj. č.: 209-176</b> Upevňovací šrouby; Pro kabelovou příchytku; 4- až 6pól.	<a href="http://www.wago.com/209-176">www.wago.com/209-176</a>
	<b>Obj. č.: 209-177</b> Kabelová příchytka; Pro odlehčení tahu; 4- až 6pól.	<a href="http://www.wago.com/209-177">www.wago.com/209-177</a>

### Marking accessories

	<b>Obj. č.: 2009-115</b> WMB Inline; Pro Smart Printer; Na cívce; Flexibilní, 5–5,2 mm; Bez potisku; Možnost naklapnutí; Bílá	<a href="http://www.wago.com/2009-115">www.wago.com/2009-115</a>
	<b>Obj. č.: 2009-115/000-002</b> WMB Inline; Pro Smart Printer; Na cívce; Flexibilní, 5–5,2 mm; Bez potisku; Možnost naklapnutí; Žlutá	<a href="http://www.wago.com/2009-115/000-002">www.wago.com/2009-115/000-002</a>
	<b>Obj. č.: 2009-115/000-006</b> WMB Inline; Pro Smart Printer; Na cívce; Flexibilní, 5–5,2 mm; Bez potisku; Možnost naklapnutí; Modrá	<a href="http://www.wago.com/2009-115/000-006">www.wago.com/2009-115/000-006</a>
	<b>Obj. č.: 2009-115/000-007</b> WMB Inline; Pro Smart Printer; Na cívce; Flexibilní, 5–5,2 mm; Bez potisku; Možnost naklapnutí; Šedá	<a href="http://www.wago.com/2009-115/000-007">www.wago.com/2009-115/000-007</a>
	<b>Obj. č.: 2009-115/000-012</b> WMB Inline; Pro Smart Printer; Na cívce; Flexibilní, 5–5,2 mm; Bez potisku; Možnost naklapnutí; Oranžová	<a href="http://www.wago.com/2009-115/000-012">www.wago.com/2009-115/000-012</a>
	<b>Obj. č.: 2009-115/000-017</b> WMB Inline; Pro Smart Printer; Na cívce; Flexibilní, 5–5,2 mm; Bez potisku; Možnost naklapnutí; Světle zelená	<a href="http://www.wago.com/2009-115/000-017">www.wago.com/2009-115/000-017</a>
	<b>Obj. č.: 2009-115/000-023</b> WMB Inline; Pro Smart Printer; Na cívce; Flexibilní, 5–5,2 mm; Bez potisku; Možnost naklapnutí; Zelená	<a href="http://www.wago.com/2009-115/000-023">www.wago.com/2009-115/000-023</a>
	<b>Obj. č.: 2009-115/000-024</b> WMB Inline; Pro Smart Printer; Na cívce; Flexibilní, 5–5,2 mm; Bez potisku; Možnost naklapnutí; Fialová	<a href="http://www.wago.com/2009-115/000-024">www.wago.com/2009-115/000-024</a>

	<b>Obj. č.: 793-501</b> Popisovací karta WMB; Jako karta; Neflexibilní; Bez potisku; Možnost naklapnutí; Bílá	<a href="http://www.wago.com/793-501">www.wago.com/793-501</a>
	<b>Obj. č.: 793-501/000-002</b> Popisovací karta WMB; Jako karta; Neflexibilní; Bez potisku; Možnost naklapnutí; Bílá	<a href="http://www.wago.com/793-501/000-002">www.wago.com/793-501/000-002</a>
	<b>Obj. č.: 793-501/000-005</b> Popisovací karta WMB; Jako karta; Neflexibilní; Bez potisku; Možnost naklapnutí; Červená	<a href="http://www.wago.com/793-501/000-005">www.wago.com/793-501/000-005</a>
	<b>Obj. č.: 793-501/000-006</b> Popisovací karta WMB; Jako karta; Neflexibilní; Bez potisku; Možnost naklapnutí; Modrá	<a href="http://www.wago.com/793-501/000-006">www.wago.com/793-501/000-006</a>
	<b>Obj. č.: 793-501/000-007</b> Popisovací karta WMB; Jako karta; Neflexibilní; Bez potisku; Možnost naklapnutí; Šedá	<a href="http://www.wago.com/793-501/000-007">www.wago.com/793-501/000-007</a>
	<b>Obj. č.: 793-501/000-012</b> Popisovací karta WMB; Jako karta; Neflexibilní; Bez potisku; Možnost naklapnutí; Oranžová	<a href="http://www.wago.com/793-501/000-012">www.wago.com/793-501/000-012</a>
	<b>Obj. č.: 793-501/000-017</b> Popisovací karta WMB; Jako karta; Neflexibilní; Bez potisku; Možnost naklapnutí; Světle zelená	<a href="http://www.wago.com/793-501/000-017">www.wago.com/793-501/000-017</a>
	<b>Obj. č.: 793-501/000-023</b> Popisovací karta WMB; Jako karta; Neflexibilní; Bez potisku; Možnost naklapnutí; Zelená	<a href="http://www.wago.com/793-501/000-023">www.wago.com/793-501/000-023</a>
	<b>Obj. č.: 793-501/000-024</b> Popisovací karta WMB; Jako karta; Neflexibilní; Bez potisku; Možnost naklapnutí; Fialová	<a href="http://www.wago.com/793-501/000-024">www.wago.com/793-501/000-024</a>
	<b>Obj. č.: 793-5501</b> Popisovací karta WMB; Jako karta; Pro svorky o šířce 5–17,5 mm; Flexibilní, 5–5,2 mm; Bez potisku; Možnost naklapnutí; Bílá	<a href="http://www.wago.com/793-5501">www.wago.com/793-5501</a>
	<b>Obj. č.: 793-5501/000-002</b> Popisovací karta WMB; Jako karta; Pro svorky o šířce 5–17,5 mm; Flexibilní, 5–5,2 mm; Bez potisku; Možnost naklapnutí; Žlutá	<a href="http://www.wago.com/793-5501/000-002">www.wago.com/793-5501/000-002</a>
	<b>Obj. č.: 793-5501/000-005</b> Popisovací karta WMB; Jako karta; Flexibilní, 5–5,2 mm; Bez potisku; Možnost naklapnutí; Červená	<a href="http://www.wago.com/793-5501/000-005">www.wago.com/793-5501/000-005</a>
	<b>Obj. č.: 793-5501/000-006</b> Popisovací karta WMB; Jako karta; Flexibilní, 5–5,2 mm; Bez potisku; Možnost naklapnutí; Modrá	<a href="http://www.wago.com/793-5501/000-006">www.wago.com/793-5501/000-006</a>
	<b>Obj. č.: 793-5501/000-007</b> Popisovací karta WMB; Jako karta; Flexibilní, 5–5,2 mm; Bez potisku; Možnost naklapnutí; Šedá	<a href="http://www.wago.com/793-5501/000-007">www.wago.com/793-5501/000-007</a>
	<b>Obj. č.: 793-5501/000-012</b> Popisovací karta WMB; Jako karta; Flexibilní, 5–5,2 mm; Bez potisku; Možnost naklapnutí; Oranžová	<a href="http://www.wago.com/793-5501/000-012">www.wago.com/793-5501/000-012</a>



Obj. č.: 793-5501/000-014  
WMB marking card; as card; stretchable 5 - 5.2 mm; plain; snap-on type; brown

[www.wago.com/793-5501/000-014](http://www.wago.com/793-5501/000-014)



Obj. č.: 793-5501/000-017  
Popisovací karta WMB; Jako karta; Flexibilní, 5–5,2 mm; Bez potisku; Možnost naklapnutí; Světle zelená

[www.wago.com/793-5501/000-017](http://www.wago.com/793-5501/000-017)



Obj. č.: 793-5501/000-023  
Popisovací karta WMB; Jako karta; Flexibilní, 5–5,2 mm; Bez potisku; Možnost naklapnutí; Zelená

[www.wago.com/793-5501/000-023](http://www.wago.com/793-5501/000-023)



Obj. č.: 793-5501/000-024  
Popisovací karta WMB; Jako karta; Flexibilní, 5–5,2 mm; Bez potisku; Možnost naklapnutí; Fialová

[www.wago.com/793-5501/000-024](http://www.wago.com/793-5501/000-024)

## Ke stažení

### Documentation

#### Additional Information

Technical explanations	03-Apr-2019	pdf 3,6 MB	Stáhnout
------------------------	-------------	---------------	----------

### CAD/CAE-Data

#### CAD data

2D/3D Models 232-605	URL	Stáhnout
----------------------	-----	----------

#### CAE data

EPLAN Data Portal 232-605	Stáhnout
---------------------------	----------

## Handling Instructions

### Assembly

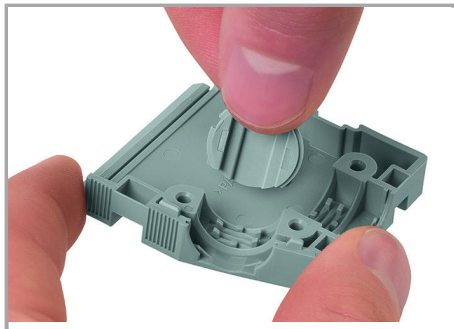

Snapping a cover into the unused cable outlet.

### Assembly

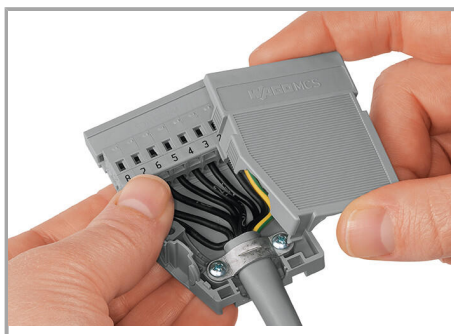

Strain relief housing shown with a male connector equipped with CAGE CLAMP®

### Assembly

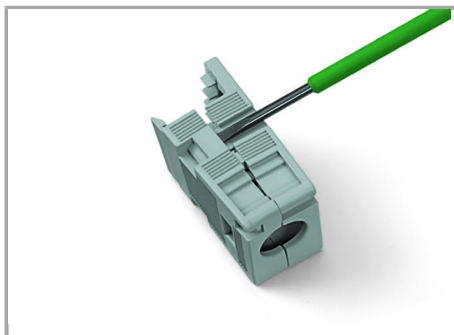

Disassembling a strain relief housing is only possible using an operating tool (e.g., 210-Zrňny vyhrazeny.