

Datový list | Objednáací číslo: 281-622/281-542

2vodičová pojistková svorka; S výklopným držákem pojistek; Pro pojistkovou vložku G 5 × 30 mm; S indikací poruchy LED diodou; 30–65 V; Na DIN lištu 35 × 15 a 35 × 7,5; 4 mm²; CAGE CLAMP®; 4,00 mm²; Šedá

www.wago.com/281-622/281-542

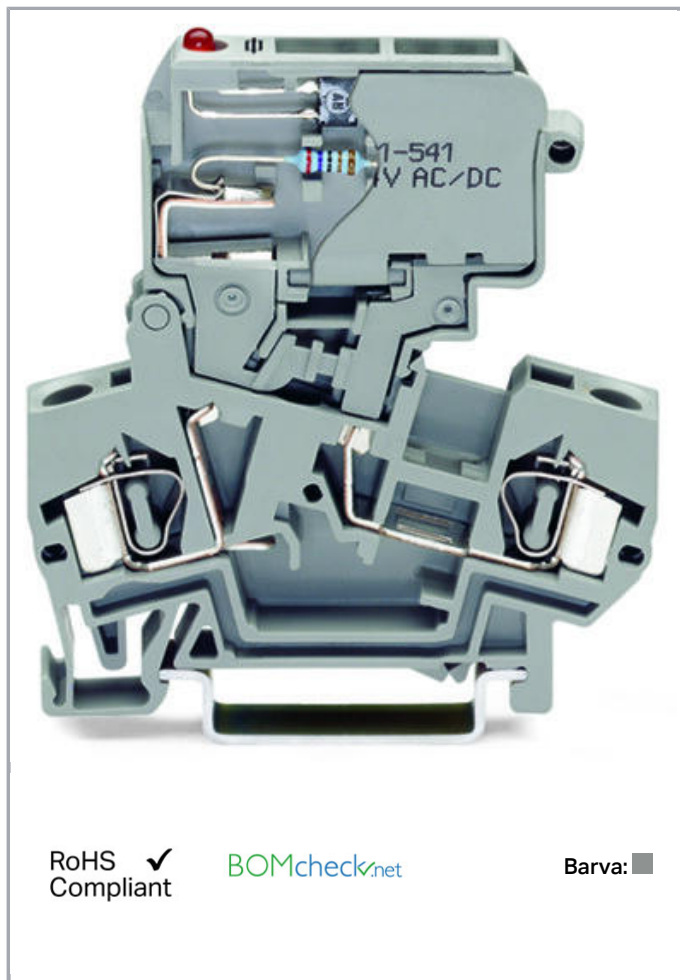

Popis položky

Upozornění:

Terminating Aluminum Conductors

WAGO spring clamp terminal blocks are suitable for solid aluminum conductors up to 4 mm²/12 AWG if WAGO "Alu-Plus" Contact Paste is used for termination.

"Alu-Plus" Contact Paste Advantages:

- Automatically destroys the oxide film during clamping.
- Prevents fresh oxidation at the clamping point.
- Prevents electrolytic corrosion between aluminum and copper conductors (in the same terminal block).
- Provides long-term protection against corrosion.



Using terminal blocks with CAGE CLAMP® Spring Pressure Connection Technology, **aluminum conductors must first be cleaned with a blade and then immediately be inserted into the clamping units filled with "Alu-Plus" Contact Paste.**

It is also possible to apply WAGO "Alu-Plus" **additionally** on the whole surface of the aluminum conductor before termination.

Please note that the nominal currents must be adapted to the reduced conductivity of the aluminum conductors:

2.5 mm² (14 AWG) = 16 A

4 mm² (12 AWG) = 22 A

Bezpečnostní upozornění 1:

Elektrické parametry jsou určovány pojistkou a indikací poruchy.

Bezpečnostní upozornění 2:

Zbytkový proud při vadné pojistce: LED 6 mA

Data

Elektrické parametry

Ratings per IEC/EN 60664-1

Návrhové napětí (III / 3)	800 V
Návrhové rázové napětí (III / 3)	8 kV
Jmenovitý proud	10 A
Legenda (návrhové hodnoty)	(III / 3) ≙ kategorie přepětí III / stupeň znečištění 3

Údaje o připojení

Připojovací technika	CAGE CLAMP®
Způsob ovládání	Ovládací nástroj
Materiály připojitelných vodičů	Měď Hliník
Plný vodič	0,08 ... 4 mm ² / 28 ... 12 AWG
Jemně laněný vodič	0,08 ... 4 mm ² / 28 ... 12 AWG
Délka odizolování	9 ... 10 mm / 0.35 ... 0.39 palec
Celkový počet kontaktních míst	2
Celkový počet potenciálů	2
Počet úrovní	1
Způsob zapojení	čelní připojení

Geometrické údaje

Šířka	8 mm / 0.315 inch
Výška od horní hrany lišty DIN 35	60 mm / 2.362 inch
Hloubka	60 mm / 2.362 inch

Mechanické parametry

Provedení	Úhlové provedení
-----------	------------------

Způsob montáže	Lišta DIN 35
Úroveň popisování	Středový popis

Údaje o materiálu



barva	Šedá
Izolační materiál	Polyamid 66 (PA 66)
Požární zatížení	0.338 MJ
Hmotnost	17.867 g

Obchodní údaje



Product Group	1 (Rail Mounted Terminal Blocks)
Druh balení	BOX
Country of origin	DE
GTIN	4045454317881
Customs Tariff No.	85369095990

Atesty/certifikáty

Specifické atesty jednotlivých států

Logo	Schválení	Doplňkový text schválení	Název certifikátu
	CSA DEKRA Certification B.V.	C22.2 No. 158	1505034
	KEMA/KEUR DEKRA Certification B.V.	EN 60947	NTR NL- 7135
	KEMA/KEUR DEKRA Certification B.V.	EN 60947	2160584.31

Atesty pro použití v lodním průmyslu



Logo	Schválení	Doplňkový text schválení	Název certifikátu
	ABS American Bureau of Shipping	-	14- HG1293677- PDA
	DNV GL Det Norske Veritas, Germanischer Lloyd	-	TAE00001V2

Atesty UL



Logo	Schválení	Doplňkový text schválení	Název certifikátu
	UR Underwriters Laboratories Inc.	UL 1059	E45172

Kompatibilní produkty



End plate

	Obj. č.: 281-309 Koncová bočnice a separátor; Tloušťka 2,5 mm; Oranžová	www.wago.com/281-309
	Obj. č.: 281-311 Koncová bočnice a separátor; Tloušťka 2,5 mm; Šedá	www.wago.com/281-311

tools

	Obj. č.: 210-657 Ovládací nástroj; Břit: 3,5 × 0,5 mm; S částečně izolovanou rukojetí; Krátké	www.wago.com/210-657
	Obj. č.: 210-658 Ovládací nástroj; Břit: 3,5 × 0,5 mm; S částečně izolovanou rukojetí; Úhlové provedení; Krátké	www.wago.com/210-658
	Obj. č.: 210-720 Ovládací nástroj; Břit: 3,5 × 0,5 mm; S částečně izolovanou rukojetí	www.wago.com/210-720

assembling















	Obj. č.: 209-106 Držák; K izolované montáži nosných lišt DIN 35; Šedá	www.wago.com/209-106
	Obj. č.: 709-153 Krycí profil; Typ 1; Vhodný pro držák krycího profilu typu 1; Délka 1 m; Transparentní	www.wago.com/709-153















N-busbar

	Obj. č.: 210-254 Pojistný profil; Ke spojení několika odpojovacích páček; Délka 1 m; Transparentní	www.wago.com/210-254
--	---	--

ferrule

	Obj. č.: 216-106 Dutinka; Objímka na 2,5 mm ² / AWG 14; Bez plastového límce; Galvanicky pocínováno	www.wago.com/216-106
--	---	--

	Obj. č.: 216-201 Ferrule; Sleeve for 0.5 mm ² / 20 AWG; insulated; electro-tin plated; white	www.wago.com/216-201
	Obj. č.: 216-202 Ferrule; Sleeve for 0.75 mm ² / 18 AWG; insulated; electro-tin plated; gray	www.wago.com/216-202
	Obj. č.: 216-203 Dutinka; Objímka na 1 mm ² / AWG 18; S plastovým límcem; Galvanicky pocínováno; Červená	www.wago.com/216-203
	Obj. č.: 216-204 Dutinka; Objímka na 1,5 mm ² / AWG 16; S plastovým límcem; Galvanicky pocínováno; Černá	www.wago.com/216-204
	Obj. č.: 216-205 Dutinka; Objímka na 2,08 mm ² / AWG 14; S plastovým límcem; Galvanicky pocínováno; Žlutá	www.wago.com/216-205
	Obj. č.: 216-206 Dutinka; Objímka na 2,5 mm ² / AWG 14; S plastovým límcem; Galvanicky pocínováno; Modrá	www.wago.com/216-206
	Obj. č.: 216-241 Ferrule; Sleeve for 0.5 mm ² / 20 AWG; insulated; electro-tin plated; electrolytic copper; gastight crimped; acc. to DIN 46228, Part 4/09.90; white	www.wago.com/216-241
	Obj. č.: 216-242 Ferrule; Sleeve for 0.75 mm ² / 18 AWG; insulated; electro-tin plated; electrolytic copper; gastight crimped; acc. to DIN 46228, Part 4/09.90; gray	www.wago.com/216-242
	Obj. č.: 216-243 Dutinka; Objímka na 1 mm ² / AWG 18; S plastovým límcem; Galvanicky pocínováno; Elektrolytická měď; Plynotěsně osazena; Dle DIN 46228, část 4/09.90; Červená	www.wago.com/216-243
	Obj. č.: 216-244 Dutinka; Objímka na 1,5 mm ² / AWG 16; S plastovým límcem; Galvanicky pocínováno; Elektrolytická měď; Plynotěsně osazena; Dle DIN 46228, část 4/09.90; Černá	www.wago.com/216-244
	Obj. č.: 216-246 Dutinka; Objímka na 2,5 mm ² / AWG 14; S plastovým límcem; Galvanicky pocínováno; Elektrolytická měď; Plynotěsně osazena; Dle DIN 46228, část 4/09.90; Modrá	www.wago.com/216-246
	Obj. č.: 216-301 Dutinka; Objímka na 0,25 mm ² / AWG 24; S plastovým límcem; Galvanicky pocínováno; Žlutá	www.wago.com/216-301
	Obj. č.: 216-302 Ferrule; Sleeve for 0.34 mm ² / 22 AWG; insulated; electro-tin plated; green	www.wago.com/216-302
Carrier rail		
	Obj. č.: 210-112 Ocelová nosná lišta; 35 × 7,5 mm; Tloušťka 1 mm; Délka 2 m; Děrovaná; Dle normy EN 60715; Šířka otvorů 25 mm; vzdálenost mezi otvory 36 mm	www.wago.com/210-112
	Obj. č.: 210-113 Ocelová nosná lišta; 35 × 7,5 mm; Tloušťka 1 mm; Délka 2 m; Neděrovaná; Dle normy EN 60715	www.wago.com/210-113
	Obj. č.: 210-114 Ocelová nosná lišta; 35 × 15 mm; Tloušťka 1,5 mm; Délka 2 m; Neděrovaná; Podobné EN 60715	www.wago.com/210-114
	Obj. č.: 210-115 Ocelová nosná lišta; 35 × 7,5 mm; Tloušťka 1 mm; Délka 2 m; Děrovaná; Dle normy EN 60715; Šířka otvorů 18 mm; vzdálenost mezi otvory 25 mm	www.wago.com/210-115
	Obj. č.: 210-118 Ocelová nosná lišta; 35 × 15 mm; Tloušťka 2,3 mm; Délka 2 m; Neděrovaná; Dle normy EN 60715	www.wago.com/210-118
	Obj. č.: 210-196	

	Hliníková nosná lišta; 35 × 8,2 mm; Tloušťka 1,6 mm; Délka 2 m; Neděrovaná; Podobné EN 60715; Stříbrná	www.wago.com/210-196
	Obj. č.: 210-197 Ocelová nosná lišta; 35 × 15 mm; Tloušťka 1,5 mm; Délka 2 m; Děrovaná; Podobné EN 60715	www.wago.com/210-197
	Obj. č.: 210-198 Měděná nosná lišta; 35 × 15 mm; Tloušťka 2,3 mm; Délka 2 m; Neděrovaná; Dle normy EN 60715; Měděná	www.wago.com/210-198
	Obj. č.: 210-504 Ocelová nosná lišta; 35 × 7,5 mm; Tloušťka 1 mm; Délka 2 m; Děrovaná; Pásově zinkováno; Dle normy EN 60715	www.wago.com/210-504
	Obj. č.: 210-505 Ocelová nosná lišta; 35 × 7,5 mm; Tloušťka 1 mm; Délka 2 m; Neděrovaná; Pásově zinkováno; Dle normy EN 60715	www.wago.com/210-505
	Obj. č.: 210-506 Ocelová nosná lišta; 35 × 15 mm; Tloušťka 1,5 mm; Délka 2 m; Neděrovaná; Pásově zinkováno; Podobné EN 60715	www.wago.com/210-506
	Obj. č.: 210-508 Ocelová nosná lišta; 35 × 15 mm; Tloušťka 1,5 mm; Délka 2 m; Děrovaná; Pásově zinkováno; Podobné EN 60715	www.wago.com/210-508
Marking accessories		
	Obj. č.: 2009-115 WMB Inline; Pro Smart Printer; Na cívce; Flexibilní, 5–5,2 mm; Bez potisku; Možnost naklapnutí; Bílá	www.wago.com/2009-115
	Obj. č.: 2009-115/000-002 WMB Inline; Pro Smart Printer; Na cívce; Flexibilní, 5–5,2 mm; Bez potisku; Možnost naklapnutí; Žlutá	www.wago.com/2009-115/000-002
	Obj. č.: 2009-115/000-006 WMB Inline; Pro Smart Printer; Na cívce; Flexibilní, 5–5,2 mm; Bez potisku; Možnost naklapnutí; Modrá	www.wago.com/2009-115/000-006
	Obj. č.: 2009-115/000-007 WMB Inline; Pro Smart Printer; Na cívce; Flexibilní, 5–5,2 mm; Bez potisku; Možnost naklapnutí; Šedá	www.wago.com/2009-115/000-007
	Obj. č.: 2009-115/000-012 WMB Inline; Pro Smart Printer; Na cívce; Flexibilní, 5–5,2 mm; Bez potisku; Možnost naklapnutí; Oranžová	www.wago.com/2009-115/000-012
	Obj. č.: 2009-115/000-017 WMB Inline; Pro Smart Printer; Na cívce; Flexibilní, 5–5,2 mm; Bez potisku; Možnost naklapnutí; Světle zelená	www.wago.com/2009-115/000-017
	Obj. č.: 2009-115/000-023 WMB Inline; Pro Smart Printer; Na cívce; Flexibilní, 5–5,2 mm; Bez potisku; Možnost naklapnutí; Zelená	www.wago.com/2009-115/000-023
	Obj. č.: 2009-115/000-024 WMB Inline; Pro Smart Printer; Na cívce; Flexibilní, 5–5,2 mm; Bez potisku; Možnost naklapnutí; Fialová	www.wago.com/2009-115/000-024
	Obj. č.: 793-501 Popisovací karta WMB; Jako karta; Neflexibilní; Bez potisku; Možnost naklapnutí; Bílá	www.wago.com/793-501



Obj. č.: 793-501/000-002
Popisovací karta WMB; Jako karta; Neflexibilní; Bez potisku; Možnost naklapnutí; Bílá

www.wago.com/793-501/000-002



Obj. č.: 793-501/000-005
Popisovací karta WMB; Jako karta; Neflexibilní; Bez potisku; Možnost naklapnutí; Červená

www.wago.com/793-501/000-005



Obj. č.: 793-501/000-006
Popisovací karta WMB; Jako karta; Neflexibilní; Bez potisku; Možnost naklapnutí; Modrá

www.wago.com/793-501/000-006



Obj. č.: 793-501/000-007
Popisovací karta WMB; Jako karta; Neflexibilní; Bez potisku; Možnost naklapnutí; Šedá

www.wago.com/793-501/000-007



Obj. č.: 793-501/000-012
Popisovací karta WMB; Jako karta; Neflexibilní; Bez potisku; Možnost naklapnutí; Oranžová

www.wago.com/793-501/000-012



Obj. č.: 793-501/000-017
Popisovací karta WMB; Jako karta; Neflexibilní; Bez potisku; Možnost naklapnutí; Světle zelená

www.wago.com/793-501/000-017



Obj. č.: 793-501/000-023
Popisovací karta WMB; Jako karta; Neflexibilní; Bez potisku; Možnost naklapnutí; Zelená

www.wago.com/793-501/000-023



Obj. č.: 793-501/000-024
Popisovací karta WMB; Jako karta; Neflexibilní; Bez potisku; Možnost naklapnutí; Fialová

www.wago.com/793-501/000-024



Obj. č.: 793-5501
Popisovací karta WMB; Jako karta; Pro svorky o šířce 5–17,5 mm; Flexibilní, 5–5,2 mm; Bez potisku; Možnost naklapnutí; Bílá

www.wago.com/793-5501



Obj. č.: 793-5501/000-002
Popisovací karta WMB; Jako karta; Pro svorky o šířce 5–17,5 mm; Flexibilní, 5–5,2 mm; Bez potisku; Možnost naklapnutí; Žlutá

www.wago.com/793-5501/000-002



Obj. č.: 793-5501/000-005
Popisovací karta WMB; Jako karta; Flexibilní, 5–5,2 mm; Bez potisku; Možnost naklapnutí; Červená

www.wago.com/793-5501/000-005



Obj. č.: 793-5501/000-006
Popisovací karta WMB; Jako karta; Flexibilní, 5–5,2 mm; Bez potisku; Možnost naklapnutí; Modrá

www.wago.com/793-5501/000-006



Obj. č.: 793-5501/000-007
Popisovací karta WMB; Jako karta; Flexibilní, 5–5,2 mm; Bez potisku; Možnost naklapnutí; Šedá

www.wago.com/793-5501/000-007



Obj. č.: 793-5501/000-012
Popisovací karta WMB; Jako karta; Flexibilní, 5–5,2 mm; Bez potisku; Možnost naklapnutí; Oranžová

www.wago.com/793-5501/000-012



Obj. č.: 793-5501/000-017
Popisovací karta WMB; Jako karta; Flexibilní, 5–5,2 mm; Bez potisku; Možnost naklapnutí; Světle zelená

www.wago.com/793-5501/000-017



Obj. č.: 793-5501/000-023

Popisovací karta WMB; Jako karta; Flexibilní, 5–5,2 mm; Bez potisku; Možnost naklapnutí; Zelená

www.wago.com/793-5501/000-023



Obj. č.: 793-5501/000-024

Popisovací karta WMB; Jako karta; Flexibilní, 5–5,2 mm; Bez potisku; Možnost naklapnutí; Fialová

www.wago.com/793-5501/000-024

General accessories



Obj. č.: 249-120

Nosič skupinového označení

www.wago.com/249-120



Obj. č.: 280-404

Zkušební adaptér; Šířka 5 mm; Pro zkušební hrot 210-137 (Ø 2,3 mm); Vhodná pro svorky 1,5–4 mm²; Šedá

www.wago.com/280-404



Obj. č.: 281-407

Zkušební hrot; Šířka 6 mm; Jmenovitý proud 24 A; Pro 0,08–2,5 mm²; 2,50 mm²; Šedá

www.wago.com/281-407

Jumper



Obj. č.: 210-103

Vícenásobný vodičový můstek; Izolováno; 50 přípojek; Černá

www.wago.com/210-103

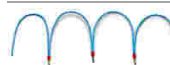

Obj. č.: 210-123

Vícenásobný vodičový můstek; Izolováno; 50 přípojek

www.wago.com/210-123



Obj. č.: 249-123

Vodičový můstek; Izolováno; L = 180 mm; Průřez vedení 0,75 mm²

www.wago.com/249-123



Obj. č.: 249-125

Vodičový můstek; Izolováno; L = 60 mm; Průřez vedení 0,75 mm²

www.wago.com/249-125



Obj. č.: 249-126

Vodičový můstek; Izolováno; L = 110 mm; Průřez vedení 0,75 mm²

www.wago.com/249-126



Obj. č.: 249-127

Vodičový můstek; Izolováno; L = 250 mm; Průřez vedení 0,75 mm²

www.wago.com/249-127



Obj. č.: 281-402

Příčný můstek; Izolováno; IN = IN svorky; Šedá

www.wago.com/281-402



Obj. č.: 709-110

Vícenásobný vodičový můstek; Izolováno; 4 přípojky; 3 × 110 mm; Černá

www.wago.com/709-110



Obj. č.: 709-111

Vícenásobný vodičový můstek; Izolováno; 3 přípojek; 2 × 120 mm; Černá

www.wago.com/709-111



Obj. č.: 709-112

Vícenásobný vodičový můstek; Izolováno; 3 přípojek; 2 × 170 mm; Černá

www.wago.com/709-112

check



Obj. č.: 210-137

Zkušební hrot; Ø 2,3 mm; S 500mm vedením; Žlutá

www.wago.com/210-137

Ke stažení

Documentation

Additional Information



Technical explanations

03-Apr-2019

pdf
2,1 MB

Stáhnout

CAD/CAE-Data

CAD data

2D/3D Models 281-622/281-542

URL

Stáhnout

CAE data

EPLAN Data Portal 281-622/281-542

Stáhnout

WSCAD Universe 281-622/281-542

Stáhnout

Handling Instructions

Inserting a conductor

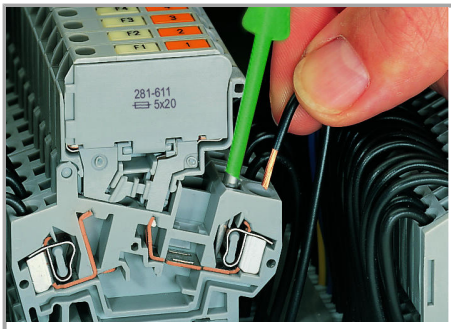

CAGE CLAMP® connection

Inserting a conductor via screwdriver.

With ferruled conductors, it is necessary to use a terminal block one size smaller than the conductor's nominal cross section.

Jumpered

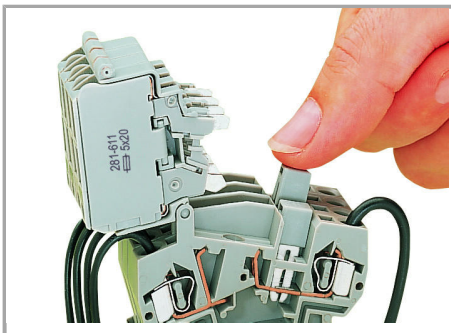

Commoning:

Distributing current to several fuse-protected circuits via insulated push-in type jumpers.

Testing

Změny vyhrazeny.

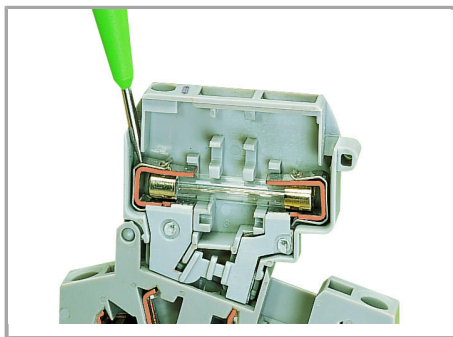

Voltage test, either at input or output with fuse holder in closed position (live)

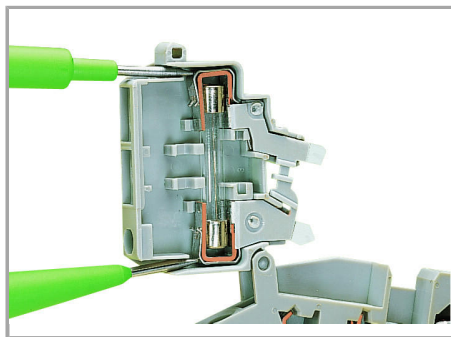

Through test with fuse holder in open position (no voltage)

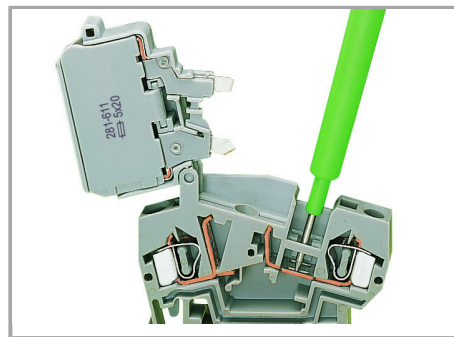

Voltage test at input in the test slot of the current bar

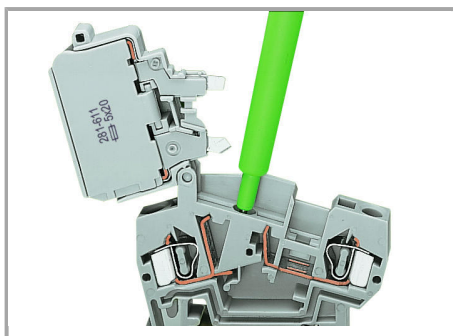

Testing voltage at the output via separate test slot.

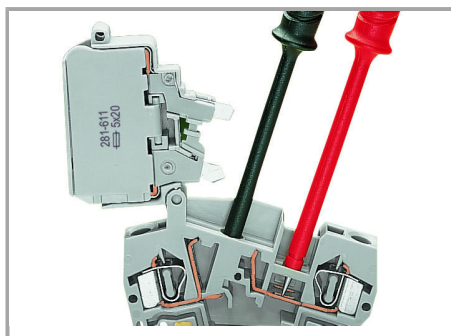

Measuring current between jumper slot and separate test slot.

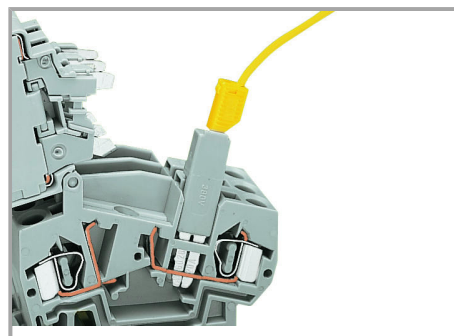

Testing voltage (input side) via test plug adapter (280-404, shown) or test plug (281-407).

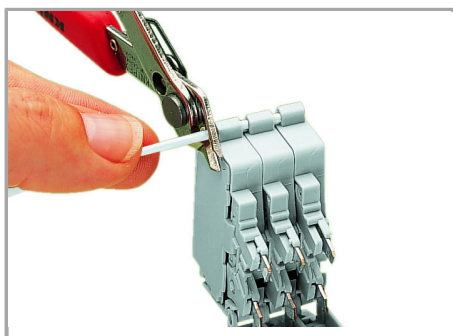

Ganging several fuse holders with an interlocking link (example shows 8 mm wide terminal blocks).

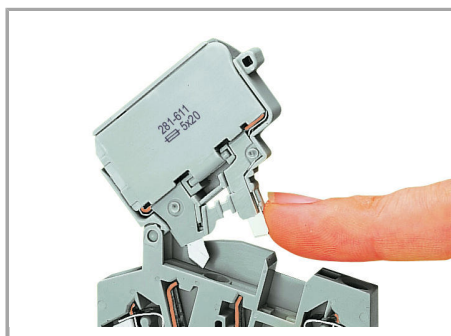

Touch-proof protection in all positions of the fuse holder

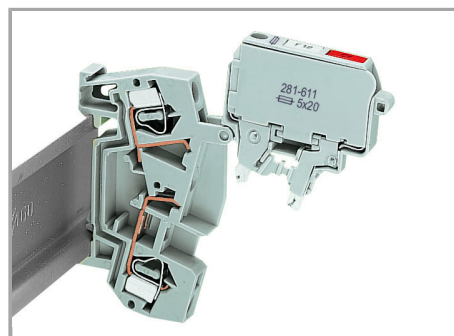

Fuse holder will remain safely locked open in vertical assemblies.

Změny vyhrazeny.

WAGO Elektro spol. sr. o.
Rozvodova 1116/36
143 00 Praha 12 - Modřany
Tel.: +420 261 090 143
Email: info.cz@wago.com, wago-cz@wago.com

Máte otázky ohledně našich produktů?
Kdykoli nám zavolejte na číslo +420 261 090 143.

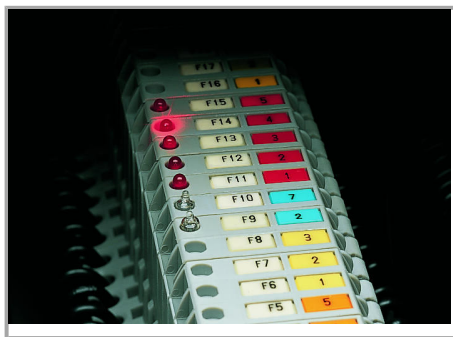

Blown fuse indication by LED or neon lamp

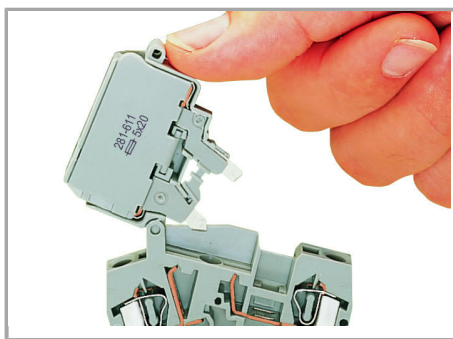

Fuse replacement:

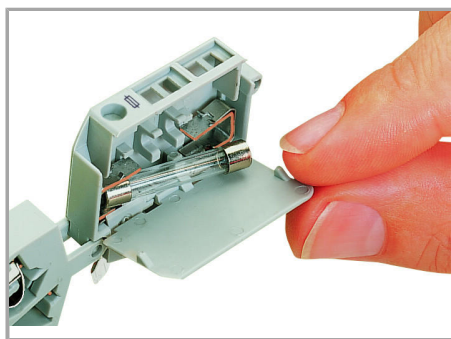

Fuse replacement:

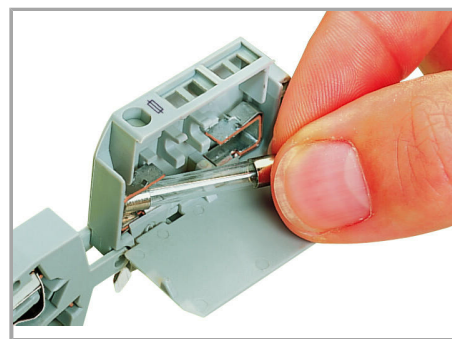

Fuse replacement:

Before replacing a fuse, pivot the fuse holder into the locked open position.

One end of the fuse is automatically ejected from the holder when opening the cover.

Easily removing a fuse by hand.

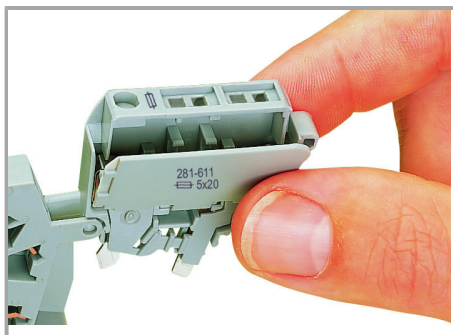

Fuse replacement:

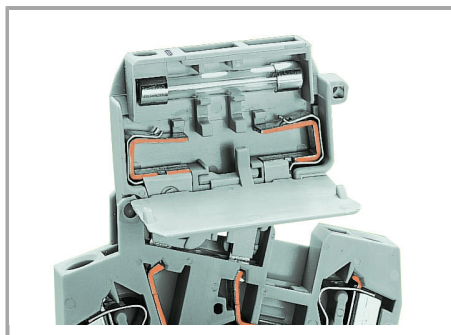

Storing a spare fuse (fuse holder without blown fuse indication).

Insert a new fuse and snap the cover closed.

Změny vyhrazeny.

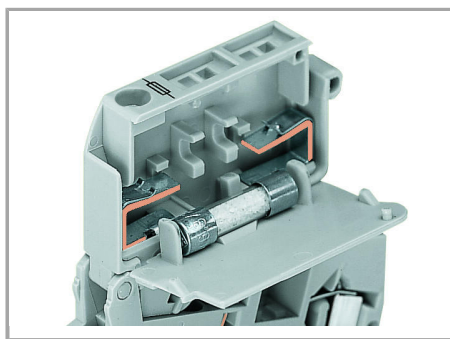
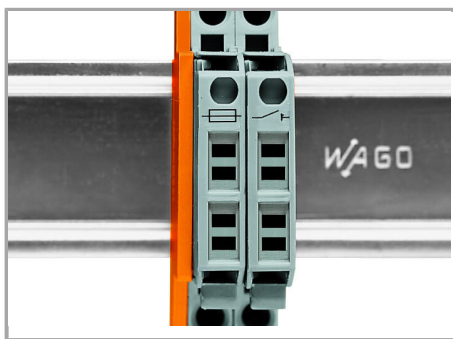

Fused disconnect or disconnect terminal blocks with a width of 8 mm can be assembled adjacently. At the end of an assembly or if there is **no** adjacent fused disconnect or disconnect terminal block, an end or intermediate plate must be used.

5 x 20 mm, 5 x 25 mm and 1/4" x 1" fuse holders are fitted with stops on the inside of the cover.

Marking

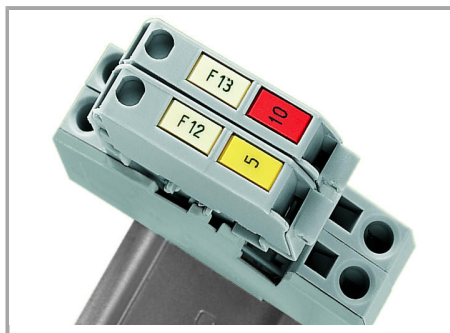
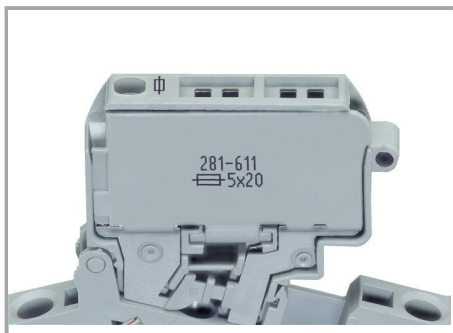

Fuse holders are printed with correct fuse size.

Je Sicherungshalter stehen 2 Aufnahmeprofile für die individuelle WMB-Multibeschriftung zur Verfügung (hier am Beispiel 8mm-Klemmenbreite).

Změny vyhrazeny.