

Datový list | Objednáací číslo: 264-292

4vodičová svorkovnice; Vhodná pro aplikace Ex e II; 12pól.; Bez tlačítka; Se západkami; Pro plech o tloušťce 0,6–1,2 mm; Upevňovací otvor Ø 3,5 mm; 2,5 mm²; CAGE CLAMP®; 2,50 mm²; Světle šedá



www.wago.com/264-292



RoHS Compliant

BOMcheck.net

Barva:

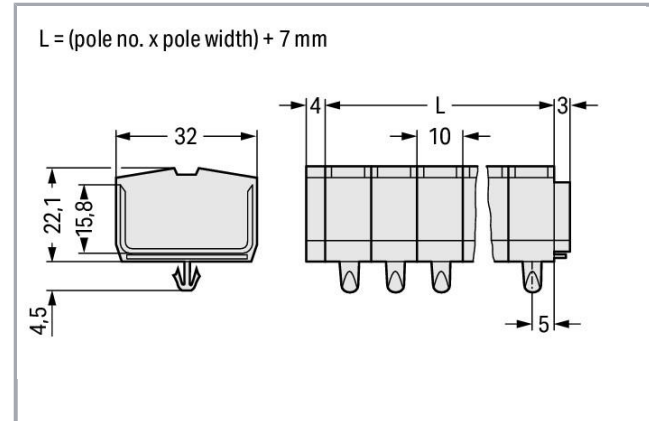

Data

Elektrické parametry

Approvals Ex

Jmenovité napětí dle EN (Ex e II)	690 V
Jmenovitý proud (Ex e II)	23 A

Údaje o připojení

Připojovací technika	CAGE CLAMP®
Způsob ovládání	Ovládací nástroj
Materiály připojitelných vodičů	Měď
Plný vodič	0,08 ... 2,5 mm ² / 28 ... 12 AWG
Jemně laněný vodič	0,08 ... 2,5 mm ² / 28 ... 12 AWG
Délka odizolování	8 ... 9 mm / 0.31 ... 0.35 palec
Počet pólů	12
Celkový počet kontaktních míst	48
Celkový počet potenciálů	12
Počet úrovní	1

Způsob zapojení	čelní připojení
Upozornění (průřez vodiče)	12 AWG: THHN, THWN

Geometrické údaje

Šířka	127 mm / 5 inch
Výška od povrchu	22,1 mm / 0.87 inch
Hloubka	32 mm / 1.26 inch
Šířka modulu	10 mm / 0.394 inch

Mechanické parametry

Provedení	Horizontální provedení
Úroveň popisování	Středový popis

Údaje o materiálu



barva	Světle šedá
Požární zatížení	1.448 MJ
Hmotnost	80 g

Obchodní údaje

Product Group	9 (Std. Chassis Mt. Blocks)
Druh balení	BOX
Country of origin	DE
GTIN	4044918415941
Customs Tariff No.	85369010000

Atesty/certifikáty

Atesty pro použití v prostředí s nebezpečím výbuchu

Logo	Schválení	Doplňkový text schválení	Název certifikátu
	AEx UL International Germany GmbH c/o Physikalisch Technische Bundesanstalt	UL 60079	E185892
	ATEX Physikalisch Technische Bundesanstalt (PTB)	EN 60079	PTB 98 ATEX 3129 U (II 2 G/D EEx e II)
	IECEX Physikalisch Technische Bundesanstalt (PTB)	IEC 60079	IECEX PTB

04.0003U
(Ex e IIC
Gb)

Specifické atesty jednotlivých států

Logo	Schválení	Doplňkový text schválení	Název certifikátu
	CSA DEKRA Certification B.V.	C22.2	70010891

Atesty pro použití v lodním průmyslu

Logo	Schválení	Doplňkový text schválení	Název certifikátu
	LR Lloyds Register	IEC 60998	91/20242 (E7)

Atesty UL

Logo	Schválení	Doplňkový text schválení	Název certifikátu
	UR Underwriters Laboratories Inc.	UL 1059	E45172, sec. 6

Kompatibilní produkty

Carrier rail

	Obj. č.: 210-154 Hliníková nosná lišta; Délka 1000 mm; Šířka 18 mm; Výška 7 mm; Stříbrná	www.wago.com/210-154
--	--	--

General accessories

	Obj. č.: 209-122 Plastová koncová svěrka; Možnost popisování systémem WSB; Na hliníkovou lištu 210-154; Šedá	www.wago.com/209-122
--	--	--

Jumper

	Obj. č.: 264-402 Vkládací můstek; Izolováno; 2x; Zmenšuje připojitelný průřez na 1,5 mm; Šedá	www.wago.com/264-402
--	---	--



Obj. č.: 280-492
Hřebenový můstek ob svorku; Izolováno; 2x; IN = IN svorky; Šedá

www.wago.com/280-492

assembling



Obj. č.: 709-153
Krycí profil; Typ 1; Vhodný pro držák krycího profilu typu 1; Délka 1 m; Transparentní

www.wago.com/709-153

check



Obj. č.: 249-139
Modul pro zkušební zástrčku; Bez zajišťovacích západek; Možnost řadového připojení; Pro 4vodičové svorky; Šedá

www.wago.com/249-139

ferrule



Obj. č.: 216-101
Dutinka; Objímka na 0,5 mm² / AWG 22; Bez plastového límce; Galvanicky pocínováno

www.wago.com/216-101



Obj. č.: 216-102
Dutinka; Objímka na 0,75 mm² / AWG 20; Bez plastového límce; Galvanicky pocínováno

www.wago.com/216-102



Obj. č.: 216-103
Dutinka; Objímka na 1 mm² / AWG 18; Bez plastového límce; Galvanicky pocínováno

www.wago.com/216-103



Obj. č.: 216-104
Dutinka; Objímka na 1,5 mm² / AWG 16; Bez plastového límce; Galvanicky pocínováno

www.wago.com/216-104



Obj. č.: 216-106
Dutinka; Objímka na 2,5 mm² / AWG 14; Bez plastového límce; Galvanicky pocínováno

www.wago.com/216-106



Obj. č.: 216-121
Dutinka; Objímka na 0,5 mm² / AWG 22; Bez plastového límce; Galvanicky pocínováno

www.wago.com/216-121



Obj. č.: 216-122
Dutinka; Objímka na 0,75 mm² / AWG 20; Bez plastového límce; Galvanicky pocínováno

www.wago.com/216-122



Obj. č.: 216-123
Dutinka; Objímka na 1 mm² / AWG 18; Bez plastového límce; Galvanicky pocínováno

www.wago.com/216-123



Obj. č.: 216-124
Dutinka; Objímka na 1,5 mm² / AWG 16; Bez plastového límce; Galvanicky pocínováno

www.wago.com/216-124



Obj. č.: 216-131
Dutinka; Objímka na 0,25 mm² / AWG 24; Bez plastového límce; Galvanicky pocínováno

www.wago.com/216-131



Obj. č.: 216-132
Dutinka; Objímka na 0,34 mm² / AWG 24; Bez plastového límce; Galvanicky pocínováno

www.wago.com/216-132



Obj. č.: 216-151
Dutinka; Objímka na 0,25 mm² / AWG 24; Bez plastového límce; Galvanicky pocínováno

www.wago.com/216-151



Obj. č.: 216-152
Dutinka; Objímka na 0,34 mm² / AWG 24; Bez plastového límce; Galvanicky pocínováno

www.wago.com/216-152



















Obj. č.: 216-201
Ferrule; Sleeve for 0.5 mm² / 20 AWG; insulated; electro-tin plated; white















www.wago.com/216-201



Obj. č.: 216-202
Ferrule; Sleeve for 0.75 mm² / 18 AWG; insulated; electro-tin plated; gray

www.wago.com/216-202

	Obj. č.: 216-203 Dutinka; Objímka na 1 mm ² / AWG 18; S plastovým límcem; Galvanicky pocínováno; Červená	www.wago.com/216-203
	Obj. č.: 216-204 Dutinka; Objímka na 1,5 mm ² / AWG 16; S plastovým límcem; Galvanicky pocínováno; Černá	www.wago.com/216-204
	Obj. č.: 216-205 Dutinka; Objímka na 2,08 mm ² / AWG 14; S plastovým límcem; Galvanicky pocínováno; Žlutá	www.wago.com/216-205
	Obj. č.: 216-206 Dutinka; Objímka na 2,5 mm ² / AWG 14; S plastovým límcem; Galvanicky pocínováno; Modrá	www.wago.com/216-206
	Obj. č.: 216-221 Ferrule; Sleeve for 0.5 mm ² / 20 AWG; insulated; electro-tin plated; white	www.wago.com/216-221
	Obj. č.: 216-222 Ferrule; Sleeve for 0.75 mm ² / 18 AWG; insulated; electro-tin plated; gray	www.wago.com/216-222
	Obj. č.: 216-223 Dutinka; Objímka na 1 mm ² / AWG 18; S plastovým límcem; Galvanicky pocínováno; Červená	www.wago.com/216-223
	Obj. č.: 216-224 Dutinka; Objímka na 1,5 mm ² / AWG 16; S plastovým límcem; Galvanicky pocínováno; Černá	www.wago.com/216-224
	Obj. č.: 216-321 Dutinka; Objímka na 0,25 mm ² / AWG 24; S plastovým límcem; Galvanicky pocínováno; Žlutá	www.wago.com/216-321
	Obj. č.: 216-322 Ferrule; Sleeve for 0.34 mm ² / 22 AWG; insulated; electro-tin plated; green	www.wago.com/216-322
tools		
	Obj. č.: 209-130 Ovládací nástroj; Vhodný pro řadu 264, 280, 281; 1×; Z izolačního materiálu	www.wago.com/209-130
	Obj. č.: 210-657 Ovládací nástroj; Břit: 3,5 × 0,5 mm; S částečně izolovanou rukojetí; Krátké	www.wago.com/210-657
	Obj. č.: 210-658 Ovládací nástroj; Břit: 3,5 × 0,5 mm; S částečně izolovanou rukojetí; Úhlové provedení; Krátké	www.wago.com/210-658
	Obj. č.: 210-720 Ovládací nástroj; Břit: 3,5 × 0,5 mm; S částečně izolovanou rukojetí	www.wago.com/210-720
	Obj. č.: 280-432 Ovládací nástroj; Z izolačního materiálu; 2×	www.wago.com/280-432
Marking accessories		
	Obj. č.: 2009-145 Mini-WSB Inline; Pro Smart Printer; Na cívce; Flexibilní, 5–5,2 mm; Bez potisku; Možnost naklapnutí; Bílá	www.wago.com/2009-145
	Obj. č.: 2009-145/000-002 Mini-WSB Inline; Pro Smart Printer; Na cívce; Flexibilní, 5–5,2 mm; Bez potisku; Možnost naklapnutí; Žlutá	www.wago.com/2009-145/000-002
	Obj. č.: 2009-145/000-005 Mini-WSB Inline; Pro Smart Printer; Na cívce; Flexibilní, 5–5,2 mm; Bez potisku; Možnost naklapnutí; Červená	www.wago.com/2009-145/000-005

	Obj. č.: 2009-145/000-006 Mini-WSB Inline; Pro Smart Printer; Na cívce; Flexibilní, 5–5,2 mm; Bez potisku; Možnost naklapnutí; Modrá	www.wago.com/2009-145/000-006
	Obj. č.: 2009-145/000-007 Mini-WSB Inline; Pro Smart Printer; Na cívce; Flexibilní, 5–5,2 mm; Bez potisku; Možnost naklapnutí; Šedá	www.wago.com/2009-145/000-007
	Obj. č.: 2009-145/000-012 Mini-WSB Inline; Pro Smart Printer; Na cívce; Flexibilní, 5–5,2 mm; Bez potisku; Možnost naklapnutí; Oranžová	www.wago.com/2009-145/000-012
	Obj. č.: 2009-145/000-023 Mini-WSB Inline; Pro Smart Printer; Na cívce; Flexibilní, 5–5,2 mm; Bez potisku; Možnost naklapnutí; Zelená	www.wago.com/2009-145/000-023
	Obj. č.: 2009-145/000-024 Mini-WSB Inline; Pro Smart Printer; Na cívce; Flexibilní, 5–5,2 mm; Bez potisku; Možnost naklapnutí; Fialová	www.wago.com/2009-145/000-024
	Obj. č.: 209-290 Popisovací svazek; Neflexibilní; Bez potisku; Možnost naklapnutí; Bílá	www.wago.com/209-290
	Obj. č.: 248-501 Systém rychlého popisování Mini-WSB; Bez potisku; Šířka štítků 5 mm; 10 řad po 10 štítcích na každé kartě	www.wago.com/248-501
	Obj. č.: 248-501/000-002 Popisovací karta Mini-WSB; Jako karta; Neflexibilní; Bez potisku; Možnost naklapnutí; Žlutá	www.wago.com/248-501/000-002
	Obj. č.: 248-501/000-005 Popisovací karta Mini-WSB; Jako karta; Neflexibilní; Bez potisku; Možnost naklapnutí; Červená	www.wago.com/248-501/000-005
	Obj. č.: 248-501/000-006 Popisovací karta Mini-WSB; Jako karta; Neflexibilní; Bez potisku; Možnost naklapnutí; Modrá	www.wago.com/248-501/000-006
	Obj. č.: 248-501/000-007 Popisovací karta Mini-WSB; Jako karta; Neflexibilní; Bez potisku; Možnost naklapnutí; Šedá	www.wago.com/248-501/000-007
	Obj. č.: 248-501/000-012 Popisovací karta Mini-WSB; Jako karta; Neflexibilní; Bez potisku; Možnost naklapnutí; Oranžová	www.wago.com/248-501/000-012
	Obj. č.: 248-501/000-017 Popisovací karta Mini-WSB; Jako karta; Neflexibilní; Bez potisku; Možnost naklapnutí; Světle zelená	www.wago.com/248-501/000-017
	Obj. č.: 248-501/000-023 Popisovací karta Mini-WSB; Jako karta; Neflexibilní; Bez potisku; Možnost naklapnutí; Zelená	www.wago.com/248-501/000-023
	Obj. č.: 248-501/000-024 Popisovací karta Mini-WSB; Jako karta; Neflexibilní; Bez potisku; Možnost naklapnutí; Fialová	www.wago.com/248-501/000-024



Ke stažení

Documentation

Additional Information

Technical explanations	03-Apr-2019	pdf 2,1 MB	Stáhnout
------------------------	-------------	---------------	----------

CAD/CAE-Data

CAD data

2D/3D Models 264-292	URL	Stáhnout
----------------------	-----	----------

CAE data

EPLAN Data Portal 264-292	Stáhnout
---------------------------	----------

WSCAD Universe 264-292	Stáhnout
------------------------	----------

Handling Instructions

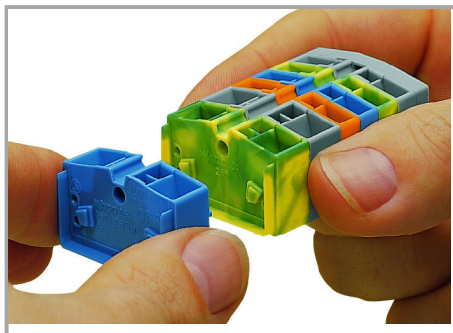

Assembling modular terminal blocks into terminal strips.

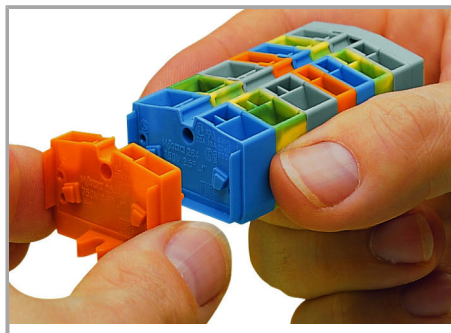

Mounting an "end terminal block" with mounting flange.

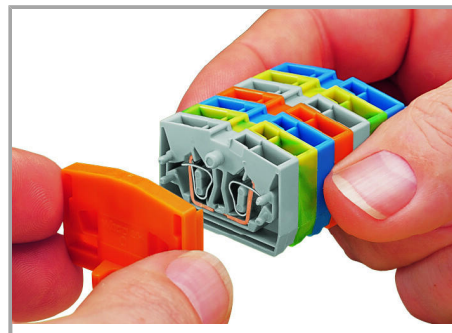

Mounting an end plate.



Removing a terminal block.

Změny vyhrazeny.

WAGO Elektro spol. sr. o.
Rozvodova 1116/36
143 00 Praha 12 - Modřany
Tel.: +420 261 090 143
Email: info.cz@wago.com, wago-cz@wago.com

Máte otázky ohledně našich produktů?
Kdykoli nám zavolejte na číslo +420 261 090 143.

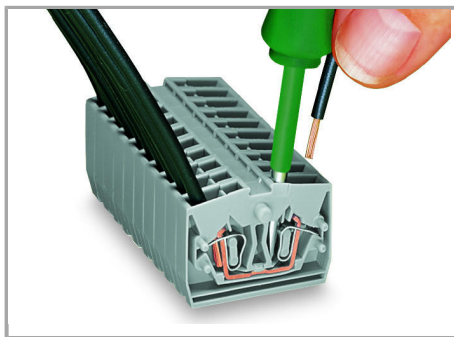

CAGE CLAMP® connection

Inserting a conductor.

With ferruled conductors, it is necessary to use a terminal block one size smaller than the conductor's nominal cross section.

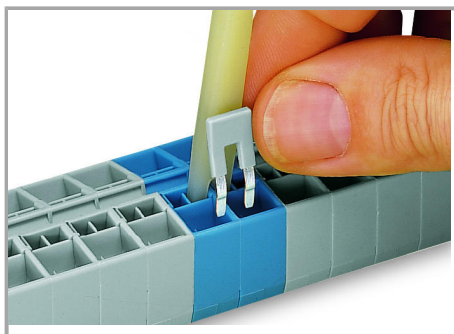

Commoning with comb-style jumper bar.

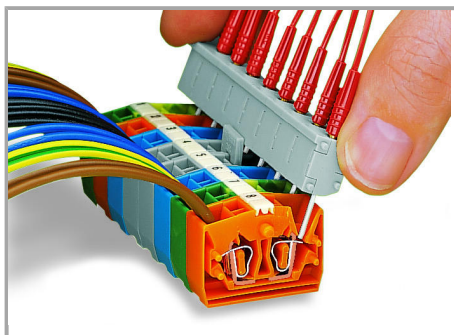

Testing by touch contact to the CAGE CLAMP® spring (limited to 0.5 A and 48 V test voltage) – test pins are not protected against accidental contact.

WAGO Elektro spol. s r. o.
Rozvodova 1116/36
143 00 Praha 12 - Modřany
Tel.: +420 261 090 143
Email: info.cz@wago.com, wago-cz@wago.com

Máte otázky ohledně našich produktů?
Kdykoli nám zavolejte na číslo +420 261 090 143.



Testing via CAGE CLAMP® on the current bar
(max. nominal current: 6 A).

CAGE CLAMP® clamps individual test
contacts.

The maximum test voltage is 400 V.



Mounting and securing a terminal strip
directly to the plate via screw-type flanges.



Mounting a terminal strip with snap-in feet
into holes.



Mounting a terminal strip with snap-in feet
onto aluminum rail.

Změny vyhrazeny.



Combining 2- and 4-conductor terminal blocks.

Marking via Mini-WSB Quick markers.

Změny vyhrazeny.

WAGO Elektro spol. sr. o.
Rozvodova 1116/36
143 00 Praha 12 - Modřany
Tel.: +420 261 090 143
Email: info.cz@wago.com, wago-cz@wago.com

Máte otázky ohledně našich produktů?
Kdykoli nám zavolejte na číslo +420 261 090 143.