

## Datový list | Objednací číslo: 264-289

4vodičová svorkovnice; Vhodná pro aplikace Ex e II; 9pól.; Bez tlačítka; Se západkami; Pro plech o tloušťce 0,6–1,2 mm; Upevňovací otvor Ø 3,5 mm; 2,5 mm<sup>2</sup>; CAGE CLAMP®; 2,50 mm<sup>2</sup>; Světle šedá



[www.wago.com/264-289](http://www.wago.com/264-289)



RoHS  Compliant

BOMcheck.net

Barva:

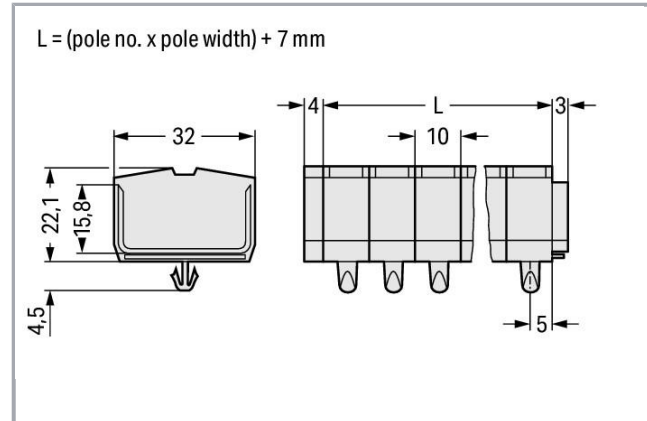

### Data

#### Elektrické parametry

#### Approvals Ex

|                                   |       |
|-----------------------------------|-------|
| Jmenovité napětí dle EN (Ex e II) | 690 V |
| Jmenovitý proud (Ex e II)         | 23 A  |

#### Údaje o připojení

|                                 |  |
|---------------------------------|--|
| Připojovací technika            | CAGE CLAMP®                                  |
| Způsob ovládání                 | Ovládací nástroj                             |
| Materiály připojitelných vodičů | Měď  |
| Plný vodič                      | 0,08 ... 2,5 mm <sup>2</sup> / 28 ... 12 AWG |
| Jemně laněný vodič              | 0,08 ... 2,5 mm <sup>2</sup> / 28 ... 12 AWG |
| Délka odizolování               | 8 ... 9 mm / 0.31 ... 0.35 palec             |
| Počet pólů                      | 9  |
| Celkový počet kontaktních míst  | 36   |
| Celkový počet potenciálů        | 9  |
| Počet úrovní                    | 1  |

|                            |                    |
|----------------------------|--------------------|
| Způsob zapojení            | čelní připojení    |
| Upozornění (průřez vodiče) | 12 AWG: THHN, THWN |

### Geometrické údaje

|                  |                     |
|------------------|---------------------|
| Šířka            | 97 mm / 3.819 inch  |
| Výška od povrchu | 22,1 mm / 0.87 inch |
| Hloubka          | 32 mm / 1.26 inch   |
| Šířka modulu     | 10 mm / 0.394 inch  |

### Mechanické parametry

|                   |                        |
|-------------------|------------------------|
| Provedení         | Horizontální provedení |
| Úroveň popisování | Středový popis         |

### Údaje o materiálu



|                  |             |
|------------------|-------------|
| barva            | Světle šedá |
| Požární zatížení | 1.1 MJ      |
| Hmotnost         | 60.5 g      |

### Obchodní údaje

|                    |                             |
|--------------------|-----------------------------|
| Product Group      | 9 (Std. Chassis Mt. Blocks) |
| Druh balení        | BOX                         |
| Country of origin  | DE                          |
| GTIN               | 4044918415910               |
| Customs Tariff No. | 85369010000                 |

### Atesty/certifikáty

#### Atesty pro použití v prostředí s nebezpečím výbuchu

| Logo   | Schválení   | Doplňkový text schválení | Název certifikátu                                  |
|--|---|--------------------------|--|
|  | AEx<br>UL International Germany GmbH c/o Physikalisch<br>Technische Bundesanstalt | UL 60079                 | E185892  |
|  | ATEX<br>Physikalisch Technische Bundesanstalt (PTB)                               | EN 60079                 | PTB 98<br>ATEX<br>3129 U (II<br>2 G/D EEx<br>e II) |
|  | IECEX<br>Physikalisch Technische Bundesanstalt (PTB)                              | IEC 60079                | IECEX<br>PTB                                       |

04.0003U  
(Ex e IIC  
Gb)

## Specifické atesty jednotlivých států

| Logo   | Schválení                       | Doplňkový text schválení | Název certifikátu |
|--|---------------------------------|--------------------------|-------------------|
|  | CSA<br>DEKRA Certification B.V. | C22.2                    | 70010891          |

## Atesty pro použití v lodním průmyslu

| Logo  | Schválení             | Doplňkový text schválení | Název certifikátu |
|---|-----------------------|--------------------------|-------------------|
|  | LR<br>Lloyds Register | IEC 60998                | 91/20242<br>(E7)  |

## Atesty UL



| Logo   | Schválení                            | Doplňkový text schválení | Název certifikátu |
|--|--------------------------------------|--------------------------|-------------------|
|  | UR<br>Underwriters Laboratories Inc. | UL 1059                  | E45172,<br>sec. 6 |



















## Kompatibilní produkty



## Carrier rail















|  |  |  |
|--|--|--|
|  | <b>Obj. č.: 210-154</b><br>Hliníková nosná lišta; Délka 1000 mm; Šířka 18 mm; Výška 7 mm; Stříbrná | <a href="http://www.wago.com/210-154">www.wago.com/210-154</a> |
|--|--|--|

## tools

|  |   |  |
|--|---|--|
|  | <b>Obj. č.: 209-130</b><br>Ovládací nástroj; Vhodný pro řadu 264, 280, 281; 1×; Z izolačního materiálu                    | <a href="http://www.wago.com/209-130">www.wago.com/209-130</a> |
|  | <b>Obj. č.: 210-657</b><br>Ovládací nástroj; Břit: 3,5 × 0,5 mm; S částečně izolovanou rukojetí; Krátké                   | <a href="http://www.wago.com/210-657">www.wago.com/210-657</a> |
|  | <b>Obj. č.: 210-658</b><br>Ovládací nástroj; Břit: 3,5 × 0,5 mm; S částečně izolovanou rukojetí; Úhlové provedení; Krátké | <a href="http://www.wago.com/210-658">www.wago.com/210-658</a> |

|  |   |  |
|--|---|--|
|    | <b>Obj. č.: 210-720</b><br>Ovládací nástroj; Břit: 3,5 × 0,5 mm; S částečně izolovanou rukojetí   | <a href="http://www.wago.com/210-720">www.wago.com/210-720</a> |
|    | <b>Obj. č.: 280-432</b><br>Ovládací nástroj; Z izolačního materiálu; 2×   | <a href="http://www.wago.com/280-432">www.wago.com/280-432</a> |
| <b>General accessories</b>   |   |  |
|    | <b>Obj. č.: 209-122</b><br>Plastová koncová svěrka; Možnost popisování systémem WSB; Na hliníkovou lištu 210-154; Šedá                    | <a href="http://www.wago.com/209-122">www.wago.com/209-122</a> |
| <b>check</b>   |   |  |
|    | <b>Obj. č.: 249-139</b><br>Modul pro zkušební zástrčku; Bez zajišťovacích západek; Možnost řadového připojení; Pro 4vodičové svorky; Šedá | <a href="http://www.wago.com/249-139">www.wago.com/249-139</a> |
| <b>ferrule</b>   |   |  |
|    | <b>Obj. č.: 216-101</b><br>Dutinka; Objímka na 0,5 mm <sup>2</sup> / AWG 22; Bez plastového límce; Galvanicky pocínováno                  | <a href="http://www.wago.com/216-101">www.wago.com/216-101</a> |
|    | <b>Obj. č.: 216-102</b><br>Dutinka; Objímka na 0,75 mm <sup>2</sup> / AWG 20; Bez plastového límce; Galvanicky pocínováno                 | <a href="http://www.wago.com/216-102">www.wago.com/216-102</a> |
|    | <b>Obj. č.: 216-103</b><br>Dutinka; Objímka na 1 mm <sup>2</sup> / AWG 18; Bez plastového límce; Galvanicky pocínováno                    | <a href="http://www.wago.com/216-103">www.wago.com/216-103</a> |
|   | <b>Obj. č.: 216-104</b><br>Dutinka; Objímka na 1,5 mm <sup>2</sup> / AWG 16; Bez plastového límce; Galvanicky pocínováno                  | <a href="http://www.wago.com/216-104">www.wago.com/216-104</a> |
|  | <b>Obj. č.: 216-106</b><br>Dutinka; Objímka na 2,5 mm <sup>2</sup> / AWG 14; Bez plastového límce; Galvanicky pocínováno                  | <a href="http://www.wago.com/216-106">www.wago.com/216-106</a> |
|  | <b>Obj. č.: 216-121</b><br>Dutinka; Objímka na 0,5 mm <sup>2</sup> / AWG 22; Bez plastového límce; Galvanicky pocínováno                  | <a href="http://www.wago.com/216-121">www.wago.com/216-121</a> |
|  | <b>Obj. č.: 216-122</b><br>Dutinka; Objímka na 0,75 mm <sup>2</sup> / AWG 20; Bez plastového límce; Galvanicky pocínováno                 | <a href="http://www.wago.com/216-122">www.wago.com/216-122</a> |
|  | <b>Obj. č.: 216-123</b><br>Dutinka; Objímka na 1 mm <sup>2</sup> / AWG 18; Bez plastového límce; Galvanicky pocínováno                    | <a href="http://www.wago.com/216-123">www.wago.com/216-123</a> |
|  | <b>Obj. č.: 216-124</b><br>Dutinka; Objímka na 1,5 mm <sup>2</sup> / AWG 16; Bez plastového límce; Galvanicky pocínováno                  | <a href="http://www.wago.com/216-124">www.wago.com/216-124</a> |
|  | <b>Obj. č.: 216-131</b><br>Dutinka; Objímka na 0,25 mm <sup>2</sup> / AWG 24; Bez plastového límce; Galvanicky pocínováno                 | <a href="http://www.wago.com/216-131">www.wago.com/216-131</a> |
|  | <b>Obj. č.: 216-132</b><br>Dutinka; Objímka na 0,34 mm <sup>2</sup> / AWG 24; Bez plastového límce; Galvanicky pocínováno                 | <a href="http://www.wago.com/216-132">www.wago.com/216-132</a> |
|  | <b>Obj. č.: 216-151</b><br>Dutinka; Objímka na 0,25 mm <sup>2</sup> / AWG 24; Bez plastového límce; Galvanicky pocínováno                 | <a href="http://www.wago.com/216-151">www.wago.com/216-151</a> |
|  | <b>Obj. č.: 216-152</b><br>Dutinka; Objímka na 0,34 mm <sup>2</sup> / AWG 24; Bez plastového límce; Galvanicky pocínováno                 | <a href="http://www.wago.com/216-152">www.wago.com/216-152</a> |
|  | <b>Obj. č.: 216-201</b><br>Ferrule; Sleeve for 0.5 mm <sup>2</sup> / 20 AWG; insulated; electro-tin plated; white                         | <a href="http://www.wago.com/216-201">www.wago.com/216-201</a> |
|  | <b>Obj. č.: 216-202</b>   |  |

|  |   |  |
|--|---|--|
|     | Ferrule; Sleeve for 0.75 mm <sup>2</sup> / 18 AWG; insulated; electro-tin plated; gray  | <a href="http://www.wago.com/216-202">www.wago.com/216-202</a>                   |
|     | <b>Obj. č.: 216-203</b><br>Dutinka; Objímka na 1 mm <sup>2</sup> / AWG 18; S plastovým límcem; Galvanicky pocínováno; Červená                     | <a href="http://www.wago.com/216-203">www.wago.com/216-203</a>                   |
|     | <b>Obj. č.: 216-204</b><br>Dutinka; Objímka na 1,5 mm <sup>2</sup> / AWG 16; S plastovým límcem; Galvanicky pocínováno; Černá                     | <a href="http://www.wago.com/216-204">www.wago.com/216-204</a>                   |
|     | <b>Obj. č.: 216-205</b><br>Dutinka; Objímka na 2,08 mm <sup>2</sup> / AWG 14; S plastovým límcem; Galvanicky pocínováno; Žlutá                    | <a href="http://www.wago.com/216-205">www.wago.com/216-205</a>                   |
|     | <b>Obj. č.: 216-206</b><br>Dutinka; Objímka na 2,5 mm <sup>2</sup> / AWG 14; S plastovým límcem; Galvanicky pocínováno; Modrá                     | <a href="http://www.wago.com/216-206">www.wago.com/216-206</a>                   |
|     | <b>Obj. č.: 216-221</b><br>Ferrule; Sleeve for 0.5 mm <sup>2</sup> / 20 AWG; insulated; electro-tin plated; white                                 | <a href="http://www.wago.com/216-221">www.wago.com/216-221</a>                   |
|     | <b>Obj. č.: 216-222</b><br>Ferrule; Sleeve for 0.75 mm <sup>2</sup> / 18 AWG; insulated; electro-tin plated; gray                                 | <a href="http://www.wago.com/216-222">www.wago.com/216-222</a>                   |
|     | <b>Obj. č.: 216-223</b><br>Dutinka; Objímka na 1 mm <sup>2</sup> / AWG 18; S plastovým límcem; Galvanicky pocínováno; Červená                     | <a href="http://www.wago.com/216-223">www.wago.com/216-223</a>                   |
|     | <b>Obj. č.: 216-224</b><br>Dutinka; Objímka na 1,5 mm <sup>2</sup> / AWG 16; S plastovým límcem; Galvanicky pocínováno; Černá                     | <a href="http://www.wago.com/216-224">www.wago.com/216-224</a>                   |
|  | <b>Obj. č.: 216-321</b><br>Dutinka; Objímka na 0,25 mm <sup>2</sup> / AWG 24; S plastovým límcem; Galvanicky pocínováno; Žlutá                    | <a href="http://www.wago.com/216-321">www.wago.com/216-321</a>                   |
|   | <b>Obj. č.: 216-322</b><br>Ferrule; Sleeve for 0.34 mm <sup>2</sup> / 22 AWG; insulated; electro-tin plated; green                                | <a href="http://www.wago.com/216-322">www.wago.com/216-322</a>                   |
| <b>Marking accessories</b>   |   |  |
|  | <b>Obj. č.: 2009-145</b><br>Mini-WSB Inline; Pro Smart Printer; Na cívce; Flexibilní, 5–5,2 mm; Bez potisku; Možnost naklapnutí; Bílá             | <a href="http://www.wago.com/2009-145">www.wago.com/2009-145</a>                 |
|  | <b>Obj. č.: 2009-145/000-002</b><br>Mini-WSB Inline; Pro Smart Printer; Na cívce; Flexibilní, 5–5,2 mm; Bez potisku; Možnost naklapnutí; Žlutá    | <a href="http://www.wago.com/2009-145/000-002">www.wago.com/2009-145/000-002</a> |
|  | <b>Obj. č.: 2009-145/000-005</b><br>Mini-WSB Inline; Pro Smart Printer; Na cívce; Flexibilní, 5–5,2 mm; Bez potisku; Možnost naklapnutí; Červená  | <a href="http://www.wago.com/2009-145/000-005">www.wago.com/2009-145/000-005</a> |
|  | <b>Obj. č.: 2009-145/000-006</b><br>Mini-WSB Inline; Pro Smart Printer; Na cívce; Flexibilní, 5–5,2 mm; Bez potisku; Možnost naklapnutí; Modrá    | <a href="http://www.wago.com/2009-145/000-006">www.wago.com/2009-145/000-006</a> |
|  | <b>Obj. č.: 2009-145/000-007</b><br>Mini-WSB Inline; Pro Smart Printer; Na cívce; Flexibilní, 5–5,2 mm; Bez potisku; Možnost naklapnutí; Šedá     | <a href="http://www.wago.com/2009-145/000-007">www.wago.com/2009-145/000-007</a> |
|  | <b>Obj. č.: 2009-145/000-012</b><br>Mini-WSB Inline; Pro Smart Printer; Na cívce; Flexibilní, 5–5,2 mm; Bez potisku; Možnost naklapnutí; Oranžová | <a href="http://www.wago.com/2009-145/000-012">www.wago.com/2009-145/000-012</a> |

|  |   |  |
|--|---|--|
|    | <b>Obj. č.: 2009-145/000-023</b><br>Mini-WSB Inline; Pro Smart Printer; Na cívice; Flexibilní, 5–5,2 mm; Bez potisku; Možnost naklapnutí; Zelená  | <a href="http://www.wago.com/2009-145/000-023">www.wago.com/2009-145/000-023</a> |
|    | <b>Obj. č.: 2009-145/000-024</b><br>Mini-WSB Inline; Pro Smart Printer; Na cívice; Flexibilní, 5–5,2 mm; Bez potisku; Možnost naklapnutí; Fialová | <a href="http://www.wago.com/2009-145/000-024">www.wago.com/2009-145/000-024</a> |
|    | <b>Obj. č.: 209-290</b><br>Popisovací svazek; Neflexibilní; Bez potisku; Možnost naklapnutí; Bílá   | <a href="http://www.wago.com/209-290">www.wago.com/209-290</a>                   |
|    | <b>Obj. č.: 248-501</b><br>Systém rychlého popisování Mini-WSB; Bez potisku; Šířka štítků 5 mm; 10 řad po 10 štítcích na každé kartě              | <a href="http://www.wago.com/248-501">www.wago.com/248-501</a>                   |
|    | <b>Obj. č.: 248-501/000-002</b><br>Popisovací karta Mini-WSB; Jako karta; Neflexibilní; Bez potisku; Možnost naklapnutí; Žlutá                    | <a href="http://www.wago.com/248-501/000-002">www.wago.com/248-501/000-002</a>   |
|    | <b>Obj. č.: 248-501/000-005</b><br>Popisovací karta Mini-WSB; Jako karta; Neflexibilní; Bez potisku; Možnost naklapnutí; Červená                  | <a href="http://www.wago.com/248-501/000-005">www.wago.com/248-501/000-005</a>   |
|    | <b>Obj. č.: 248-501/000-006</b><br>Popisovací karta Mini-WSB; Jako karta; Neflexibilní; Bez potisku; Možnost naklapnutí; Modrá                    | <a href="http://www.wago.com/248-501/000-006">www.wago.com/248-501/000-006</a>   |
|   | <b>Obj. č.: 248-501/000-007</b><br>Popisovací karta Mini-WSB; Jako karta; Neflexibilní; Bez potisku; Možnost naklapnutí; Šedá                     | <a href="http://www.wago.com/248-501/000-007">www.wago.com/248-501/000-007</a>   |
|  | <b>Obj. č.: 248-501/000-012</b><br>Popisovací karta Mini-WSB; Jako karta; Neflexibilní; Bez potisku; Možnost naklapnutí; Oranžová                 | <a href="http://www.wago.com/248-501/000-012">www.wago.com/248-501/000-012</a>   |
|  | <b>Obj. č.: 248-501/000-017</b><br>Popisovací karta Mini-WSB; Jako karta; Neflexibilní; Bez potisku; Možnost naklapnutí; Světle zelená            | <a href="http://www.wago.com/248-501/000-017">www.wago.com/248-501/000-017</a>   |
|  | <b>Obj. č.: 248-501/000-023</b><br>Popisovací karta Mini-WSB; Jako karta; Neflexibilní; Bez potisku; Možnost naklapnutí; Zelená                   | <a href="http://www.wago.com/248-501/000-023">www.wago.com/248-501/000-023</a>   |
|  | <b>Obj. č.: 248-501/000-024</b><br>Popisovací karta Mini-WSB; Jako karta; Neflexibilní; Bez potisku; Možnost naklapnutí; Fialová                  | <a href="http://www.wago.com/248-501/000-024">www.wago.com/248-501/000-024</a>   |
| <b>assembling</b>  |   |  |
|  | <b>Obj. č.: 709-153</b><br>Krycí profil; Typ 1; Vhodný pro držák krycího profilu typu 1; Délka 1 m; Transparentní                                 | <a href="http://www.wago.com/709-153">www.wago.com/709-153</a>                   |
| <b>Jumper</b>  |   |  |
|  | <b>Obj. č.: 264-402</b><br>Vkládací můstek; Izolováno; 2x; Zmenšuje připojitelný průřez na 1,5 mm; Šedá   | <a href="http://www.wago.com/264-402">www.wago.com/264-402</a>                   |
|  | <b>Obj. č.: 280-492</b><br>Hřebenový můstek ob svorku; Izolováno; 2x; IN = IN svorky; Šedá  | <a href="http://www.wago.com/280-492">www.wago.com/280-492</a>                   |



## Ke stažení

### Documentation

#### Additional Information

|                        |             |               |          |
|------------------------|-------------|---------------|----------|
| Technical explanations | 03-Apr-2019 | pdf<br>2,1 MB | Stáhnout |
|------------------------|-------------|---------------|----------|

---

### CAD/CAE-Data

#### CAD data

|                      |  |     |          |
|----------------------|--|-----|----------|
| 2D/3D Models 264-289 |  | URL | Stáhnout |
|----------------------|--|-----|----------|

---

#### CAE data

|                           |  |  |          |
|---------------------------|--|--|----------|
| EPLAN Data Portal 264-289 |  |  | Stáhnout |
|---------------------------|--|--|----------|

---

|                        |  |  |          |
|------------------------|--|--|----------|
| WSCAD Universe 264-289 |  |  | Stáhnout |
|------------------------|--|--|----------|

---

## Handling Instructions

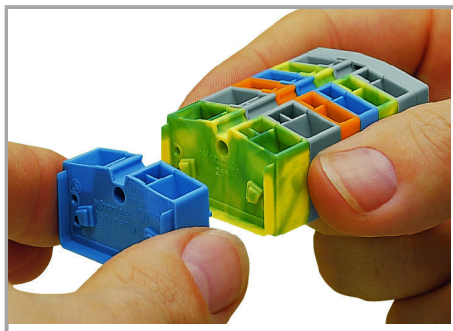

Assembling modular terminal blocks into terminal strips.

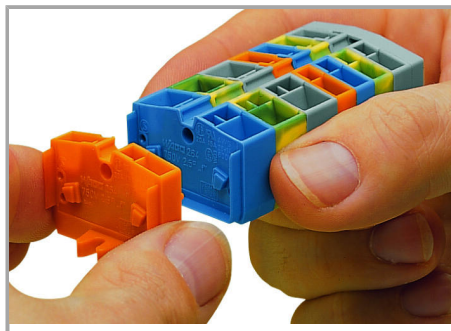

Mounting an "end terminal block" with mounting flange.

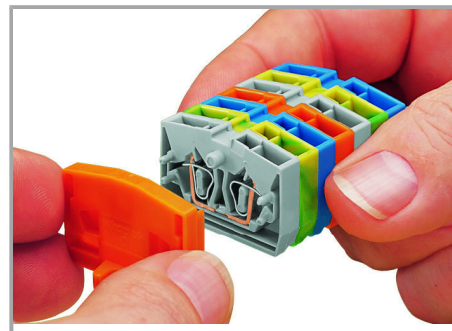

Mounting an end plate.

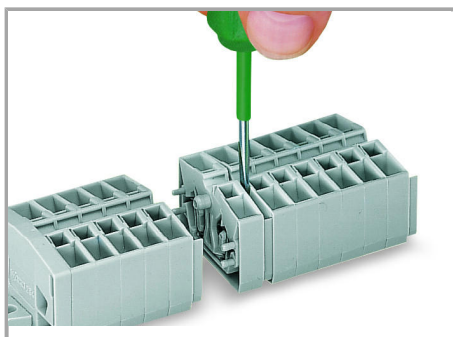

Removing a terminal block.

Změny vyhrazeny.

WAGO Elektro spol. sr. o.  
Rozvodova 1116/36  
143 00 Praha 12 - Modřany  
Tel.: +420 261 090 143  
Email: [info.cz@wago.com](mailto:info.cz@wago.com), [wago-cz@wago.com](mailto:wago-cz@wago.com)

Máte otázky ohledně našich produktů?  
Kdykoli nám zavolejte na číslo +420 261 090 143.



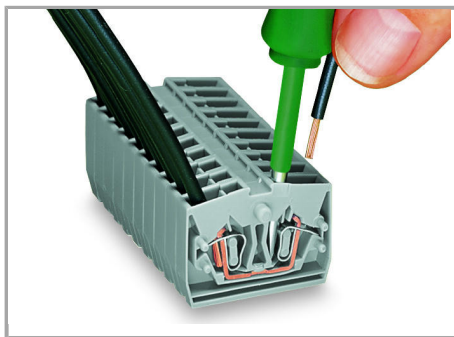

CAGE CLAMP® connection

Inserting a conductor.

With ferruled conductors, it is necessary to use a terminal block one size smaller than the conductor's nominal cross section.

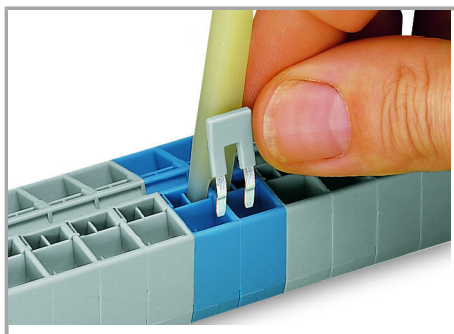

Commoning with comb-style jumper bar.

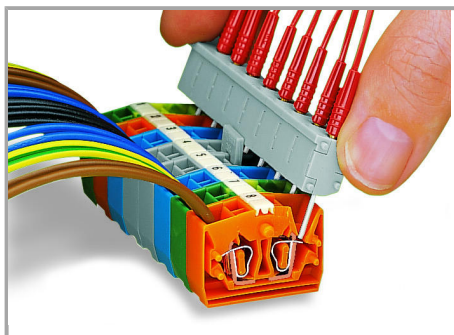

Testing by touch contact to the CAGE CLAMP® spring (limited to 0.5 A and 48 V test voltage) – test pins are not

protected against accidental contact.

WAGO Elektro spol. s r. o.

Rozvodova 1116/36

143 00 Praha 12 - Modřany

Tel.: +420 261 090 143

Email: [info.cz@wago.com](mailto:info.cz@wago.com), [wago-cz@wago.com](mailto:wago-cz@wago.com)

Máte otázky ohledně našich produktů?

Kdykoli nám zavolejte na číslo +420 261 090 143.

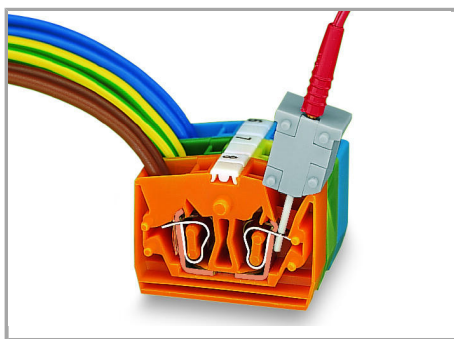

Testing via CAGE CLAMP® on the current bar  
(max. nominal current: 6 A).

CAGE CLAMP® clamps individual test  
contacts.

The maximum test voltage is 400 V.



Mounting and securing a terminal strip  
directly to the plate via screw-type flanges.

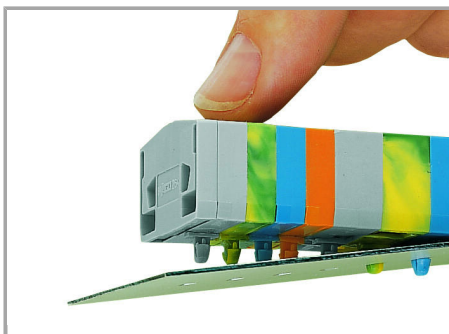

Mounting a terminal strip with snap-in feet  
into holes.

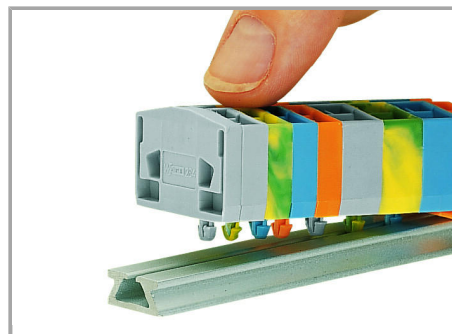

Mounting a terminal strip with snap-in feet  
onto aluminum rail.

Změny vyhrazeny.

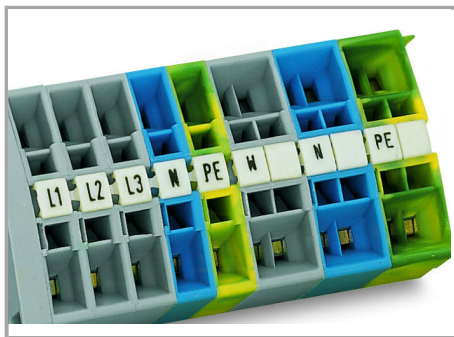

Combining 2- and 4-conductor terminal blocks.

Marking via Mini-WSB Quick markers.

Změny vyhrazeny.

---

WAGO Elektro spol. sr. o.  
Rozvodova 1116/36  
143 00 Praha 12 - Modřany  
Tel.: +420 261 090 143  
Email: [info.cz@wago.com](mailto:info.cz@wago.com), [wago-cz@wago.com](mailto:wago-cz@wago.com)

Máte otázky ohledně našich produktů?  
Kdykoli nám zavolejte na číslo +420 261 090 143.