

## Datový list | Objednací číslo: 264-260

4vodičová svorkovnice; 10pól.; Bez tlačítka; Se západkami; Pro plech o tloušťce 0,6–1,2 mm; Upevňovací otvor Ø 3,5 mm; 2,5 mm<sup>2</sup>; CAGE CLAMP®; 2,50 mm<sup>2</sup>; Šedá

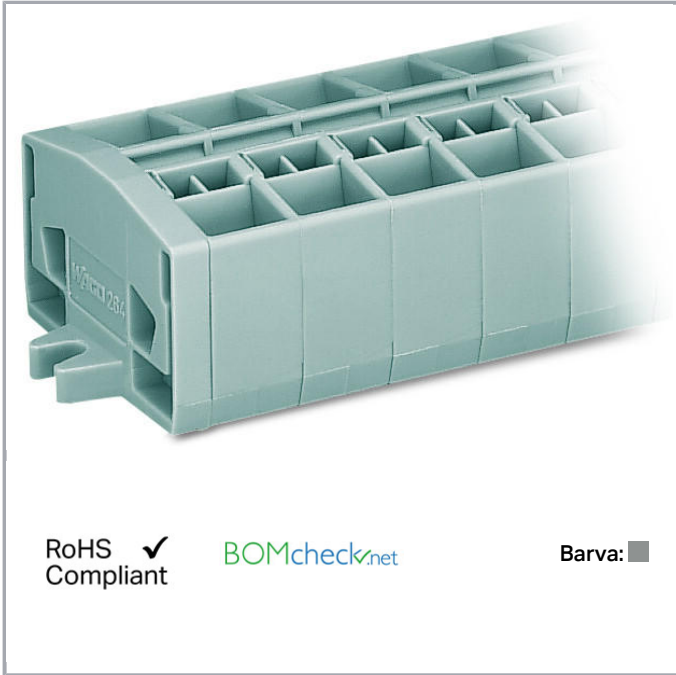

[www.wago.com/264-260](http://www.wago.com/264-260)



RoHS  
Compliant

BOMcheck.net

Barva: ■

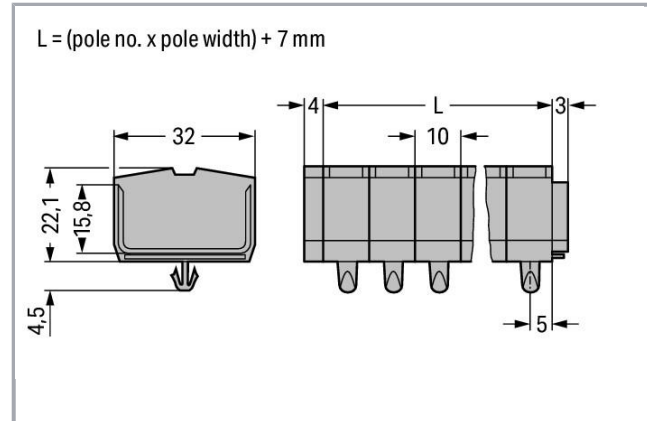

### Data

#### Elektrické parametry

#### Ratings per IEC/EN 60664-1

Návrhové napětí (III / 3)	800 V
Návrhové rázové napětí (III / 3)	8 kV
Jmenovitý proud	24 A
Legenda (návrhové hodnoty)	(III / 3) ≙ kategorie přepětí III / stupeň znečištění 3

#### Údaje o připojení

Připojovací technika	CAGE CLAMP®
Způsob ovládání	Ovládací nástroj
Materiály připojitelných vodičů	Měď
Plný vodič	0,08 ... 2,5 mm <sup>2</sup> / 28 ... 12 AWG
Jemně laněný vodič	0,08 ... 2,5 mm <sup>2</sup> / 28 ... 12 AWG
Délka odizolování	8 ... 9 mm / 0.31 ... 0.35 palec
Počet pólů	10
Celkový počet kontaktních míst	40
Celkový počet potenciálů	10

Počet úrovní	1
Způsob zapojení	čelní připojení
Upozornění (průřez vodiče)	12 AWG: THHN, THWN

### Geometrické údaje

Šířka	107 mm / 4.213 inch
Výška od povrchu	22,1 mm / 0.87 inch
Hloubka	32 mm / 1.26 inch
Šířka modulu	10 mm / 0.394 inch

### Mechanické parametry

Provedení	Horizontální provedení
Způsob upevnění	Západka
Úroveň popisování	Středový popis

### Údaje o materiálu



barva	Šedá
Požární zatížení	1.18 MJ
Hmotnost	65.7 g

### Obchodní údaje

Druh balení	BOX
Country of origin	DE
GTIN	4044918416085
Customs Tariff No.	85369010000

### Atesty/certifikáty

#### Specifické atesty jednotlivých států

Logo	Schválení	Doplňkový text schválení	Název certifikátu
	CB DEKRA Certification B.V.	EN 60998	NL-49768
	CCA DEKRA Certification B.V.	EN 60998	NTR NL-7342
	CCA DEKRA Certification B.V.	EN 60998	2175624.01
	CSA DEKRA Certification B.V.	C22.2	70010891



## Atesty pro použití v lodním průmyslu



Logo	Schválení	Doplňkový text schválení	Název certifikátu
	<b>ABS</b> American Bureau of Shipping	-	19- HG1869868- PDA
	<b>DNV GL</b> Det Norske Veritas, Germanischer Lloyd	-	TAE00001V2
	<b>LR</b> Lloyds Register	IEC 60998	91/20242 (E7)















## Atesty UL

Logo	Schválení	Doplňkový text schválení	Název certifikátu
	<b>UR</b> Underwriters Laboratories Inc.	UL 1059	E45172, sec. 6

## Kompatibilní produkty

















## Marking accessories

	<b>Obj. č.: 2009-145</b> Mini-WSB Inline; Pro Smart Printer; Na cívce; Flexibilní, 5–5,2 mm; Bez potisku; Možnost naklapnutí; Bílá	<a href="http://www.wago.com/2009-145">www.wago.com/2009-145</a>
	<b>Obj. č.: 2009-145/000-002</b> Mini-WSB Inline; Pro Smart Printer; Na cívce; Flexibilní, 5–5,2 mm; Bez potisku; Možnost naklapnutí; Žlutá	<a href="http://www.wago.com/2009-145/000-002">www.wago.com/2009-145/000-002</a>
	<b>Obj. č.: 2009-145/000-005</b> Mini-WSB Inline; Pro Smart Printer; Na cívce; Flexibilní, 5–5,2 mm; Bez potisku; Možnost naklapnutí; Červená	<a href="http://www.wago.com/2009-145/000-005">www.wago.com/2009-145/000-005</a>

	<b>Obj. č.: 2009-145/000-006</b> Mini-WSB Inline; Pro Smart Printer; Na cívce; Flexibilní, 5–5,2 mm; Bez potisku; Možnost naklapnutí; Modrá	<a href="http://www.wago.com/2009-145/000-006">www.wago.com/2009-145/000-006</a>
	<b>Obj. č.: 2009-145/000-007</b> Mini-WSB Inline; Pro Smart Printer; Na cívce; Flexibilní, 5–5,2 mm; Bez potisku; Možnost naklapnutí; Šedá	<a href="http://www.wago.com/2009-145/000-007">www.wago.com/2009-145/000-007</a>
	<b>Obj. č.: 2009-145/000-012</b> Mini-WSB Inline; Pro Smart Printer; Na cívce; Flexibilní, 5–5,2 mm; Bez potisku; Možnost naklapnutí; Oranžová	<a href="http://www.wago.com/2009-145/000-012">www.wago.com/2009-145/000-012</a>
	<b>Obj. č.: 2009-145/000-023</b> Mini-WSB Inline; Pro Smart Printer; Na cívce; Flexibilní, 5–5,2 mm; Bez potisku; Možnost naklapnutí; Zelená	<a href="http://www.wago.com/2009-145/000-023">www.wago.com/2009-145/000-023</a>
	<b>Obj. č.: 2009-145/000-024</b> Mini-WSB Inline; Pro Smart Printer; Na cívce; Flexibilní, 5–5,2 mm; Bez potisku; Možnost naklapnutí; Fialová	<a href="http://www.wago.com/2009-145/000-024">www.wago.com/2009-145/000-024</a>
	<b>Obj. č.: 209-290</b> Popisovací svazek; Neflexibilní; Bez potisku; Možnost naklapnutí; Bílá	<a href="http://www.wago.com/209-290">www.wago.com/209-290</a>
	<b>Obj. č.: 248-501</b> Systém rychlého popisování Mini-WSB; Bez potisku; Šířka štítků 5 mm; 10 řad po 10 štítcích na každé kartě	<a href="http://www.wago.com/248-501">www.wago.com/248-501</a>
	<b>Obj. č.: 248-501/000-002</b> Popisovací karta Mini-WSB; Jako karta; Neflexibilní; Bez potisku; Možnost naklapnutí; Žlutá	<a href="http://www.wago.com/248-501/000-002">www.wago.com/248-501/000-002</a>
	<b>Obj. č.: 248-501/000-005</b> Popisovací karta Mini-WSB; Jako karta; Neflexibilní; Bez potisku; Možnost naklapnutí; Červená	<a href="http://www.wago.com/248-501/000-005">www.wago.com/248-501/000-005</a>
	<b>Obj. č.: 248-501/000-006</b> Popisovací karta Mini-WSB; Jako karta; Neflexibilní; Bez potisku; Možnost naklapnutí; Modrá	<a href="http://www.wago.com/248-501/000-006">www.wago.com/248-501/000-006</a>
	<b>Obj. č.: 248-501/000-007</b> Popisovací karta Mini-WSB; Jako karta; Neflexibilní; Bez potisku; Možnost naklapnutí; Šedá	<a href="http://www.wago.com/248-501/000-007">www.wago.com/248-501/000-007</a>
	<b>Obj. č.: 248-501/000-012</b> Popisovací karta Mini-WSB; Jako karta; Neflexibilní; Bez potisku; Možnost naklapnutí; Oranžová	<a href="http://www.wago.com/248-501/000-012">www.wago.com/248-501/000-012</a>
	<b>Obj. č.: 248-501/000-017</b> Popisovací karta Mini-WSB; Jako karta; Neflexibilní; Bez potisku; Možnost naklapnutí; Světle zelená	<a href="http://www.wago.com/248-501/000-017">www.wago.com/248-501/000-017</a>
	<b>Obj. č.: 248-501/000-023</b> Popisovací karta Mini-WSB; Jako karta; Neflexibilní; Bez potisku; Možnost naklapnutí; Zelená	<a href="http://www.wago.com/248-501/000-023">www.wago.com/248-501/000-023</a>
	<b>Obj. č.: 248-501/000-024</b> Popisovací karta Mini-WSB; Jako karta; Neflexibilní; Bez potisku; Možnost naklapnutí; Fialová	<a href="http://www.wago.com/248-501/000-024">www.wago.com/248-501/000-024</a>

## ferrule

	<b>Obj. č.: 216-101</b> Dutinka; Objímka na 0,5 mm <sup>2</sup> / AWG 22; Bez plastového límce; Galvanicky pocínováno	<a href="http://www.wago.com/216-101">www.wago.com/216-101</a>
	<b>Obj. č.: 216-102</b> Dutinka; Objímka na 0,75 mm <sup>2</sup> / AWG 20; Bez plastového límce; Galvanicky pocínováno	<a href="http://www.wago.com/216-102">www.wago.com/216-102</a>
	<b>Obj. č.: 216-103</b> Dutinka; Objímka na 1 mm <sup>2</sup> / AWG 18; Bez plastového límce; Galvanicky pocínováno	<a href="http://www.wago.com/216-103">www.wago.com/216-103</a>
	<b>Obj. č.: 216-104</b> Dutinka; Objímka na 1,5 mm <sup>2</sup> / AWG 16; Bez plastového límce; Galvanicky pocínováno	<a href="http://www.wago.com/216-104">www.wago.com/216-104</a>
	<b>Obj. č.: 216-106</b> Dutinka; Objímka na 2,5 mm <sup>2</sup> / AWG 14; Bez plastového límce; Galvanicky pocínováno	<a href="http://www.wago.com/216-106">www.wago.com/216-106</a>
	<b>Obj. č.: 216-121</b> Dutinka; Objímka na 0,5 mm <sup>2</sup> / AWG 22; Bez plastového límce; Galvanicky pocínováno	<a href="http://www.wago.com/216-121">www.wago.com/216-121</a>
	<b>Obj. č.: 216-122</b> Dutinka; Objímka na 0,75 mm <sup>2</sup> / AWG 20; Bez plastového límce; Galvanicky pocínováno	<a href="http://www.wago.com/216-122">www.wago.com/216-122</a>
	<b>Obj. č.: 216-123</b> Dutinka; Objímka na 1 mm <sup>2</sup> / AWG 18; Bez plastového límce; Galvanicky pocínováno	<a href="http://www.wago.com/216-123">www.wago.com/216-123</a>
	<b>Obj. č.: 216-124</b> Dutinka; Objímka na 1,5 mm <sup>2</sup> / AWG 16; Bez plastového límce; Galvanicky pocínováno	<a href="http://www.wago.com/216-124">www.wago.com/216-124</a>
	<b>Obj. č.: 216-131</b> Dutinka; Objímka na 0,25 mm <sup>2</sup> / AWG 24; Bez plastového límce; Galvanicky pocínováno	<a href="http://www.wago.com/216-131">www.wago.com/216-131</a>
	<b>Obj. č.: 216-132</b> Dutinka; Objímka na 0,34 mm <sup>2</sup> / AWG 24; Bez plastového límce; Galvanicky pocínováno	<a href="http://www.wago.com/216-132">www.wago.com/216-132</a>
	<b>Obj. č.: 216-151</b> Dutinka; Objímka na 0,25 mm <sup>2</sup> / AWG 24; Bez plastového límce; Galvanicky pocínováno	<a href="http://www.wago.com/216-151">www.wago.com/216-151</a>
	<b>Obj. č.: 216-152</b> Dutinka; Objímka na 0,34 mm <sup>2</sup> / AWG 24; Bez plastového límce; Galvanicky pocínováno	<a href="http://www.wago.com/216-152">www.wago.com/216-152</a>
	<b>Obj. č.: 216-201</b> Ferrule; Sleeve for 0.5 mm <sup>2</sup> / 20 AWG; insulated; electro-tin plated; white	<a href="http://www.wago.com/216-201">www.wago.com/216-201</a>
	<b>Obj. č.: 216-202</b> Ferrule; Sleeve for 0.75 mm <sup>2</sup> / 18 AWG; insulated; electro-tin plated; gray	<a href="http://www.wago.com/216-202">www.wago.com/216-202</a>
	<b>Obj. č.: 216-203</b> Dutinka; Objímka na 1 mm <sup>2</sup> / AWG 18; S plastovým límcem; Galvanicky pocínováno; Červená	<a href="http://www.wago.com/216-203">www.wago.com/216-203</a>
	<b>Obj. č.: 216-204</b> Dutinka; Objímka na 1,5 mm <sup>2</sup> / AWG 16; S plastovým límcem; Galvanicky pocínováno; Černá	<a href="http://www.wago.com/216-204">www.wago.com/216-204</a>
	<b>Obj. č.: 216-205</b> Dutinka; Objímka na 2,08 mm <sup>2</sup> / AWG 14; S plastovým límcem; Galvanicky pocínováno; Žlutá	<a href="http://www.wago.com/216-205">www.wago.com/216-205</a>
	<b>Obj. č.: 216-206</b> Dutinka; Objímka na 2,5 mm <sup>2</sup> / AWG 14; S plastovým límcem; Galvanicky pocínováno; Modrá	<a href="http://www.wago.com/216-206">www.wago.com/216-206</a>
	<b>Obj. č.: 216-221</b>	

	Ferrule; Sleeve for 0.5 mm <sup>2</sup> / 20 AWG; insulated; electro-tin plated; white	<a href="http://www.wago.com/216-221">www.wago.com/216-221</a>
	<b>Obj. č.: 216-222</b> Ferrule; Sleeve for 0.75 mm <sup>2</sup> / 18 AWG; insulated; electro-tin plated; gray	<a href="http://www.wago.com/216-222">www.wago.com/216-222</a>
	<b>Obj. č.: 216-223</b> Dutinka; Objímka na 1 mm <sup>2</sup> / AWG 18; S plastovým límcem; Galvanicky pocínováno; Červená	<a href="http://www.wago.com/216-223">www.wago.com/216-223</a>
	<b>Obj. č.: 216-224</b> Dutinka; Objímka na 1,5 mm <sup>2</sup> / AWG 16; S plastovým límcem; Galvanicky pocínováno; Černá	<a href="http://www.wago.com/216-224">www.wago.com/216-224</a>
	<b>Obj. č.: 216-321</b> Dutinka; Objímka na 0,25 mm <sup>2</sup> / AWG 24; S plastovým límcem; Galvanicky pocínováno; Žlutá	<a href="http://www.wago.com/216-321">www.wago.com/216-321</a>
	<b>Obj. č.: 216-322</b> Ferrule; Sleeve for 0.34 mm <sup>2</sup> / 22 AWG; insulated; electro-tin plated; green	<a href="http://www.wago.com/216-322">www.wago.com/216-322</a>
<b>tools</b>		
	<b>Obj. č.: 209-130</b> Ovládací nástroj; Vhodný pro řadu 264, 280, 281; 1×; Z izolačního materiálu	<a href="http://www.wago.com/209-130">www.wago.com/209-130</a>
	<b>Obj. č.: 210-657</b> Ovládací nástroj; Břit: 3,5 × 0,5 mm; S částečně izolovanou rukojetí; Krátké	<a href="http://www.wago.com/210-657">www.wago.com/210-657</a>
	<b>Obj. č.: 210-658</b> Ovládací nástroj; Břit: 3,5 × 0,5 mm; S částečně izolovanou rukojetí; Úhlové provedení; Krátké	<a href="http://www.wago.com/210-658">www.wago.com/210-658</a>
	<b>Obj. č.: 210-720</b> Ovládací nástroj; Břit: 3,5 × 0,5 mm; S částečně izolovanou rukojetí	<a href="http://www.wago.com/210-720">www.wago.com/210-720</a>
	<b>Obj. č.: 280-432</b> Ovládací nástroj; Z izolačního materiálu; 2×	<a href="http://www.wago.com/280-432">www.wago.com/280-432</a>
<b>Jumper</b>		
	<b>Obj. č.: 264-402</b> Vkládací můstek; Izolováno; 2×; Zmenšuje připojitelný průřez na 1,5 mm; Šedá	<a href="http://www.wago.com/264-402">www.wago.com/264-402</a>
	<b>Obj. č.: 280-492</b> Hřebenový můstek ob svorku; Izolováno; 2×; IN = IN svorky; Šedá	<a href="http://www.wago.com/280-492">www.wago.com/280-492</a>
<b>General accessories</b>		
	<b>Obj. č.: 209-122</b> Plastová koncová svěrka; Možnost popisování systémem WSB; Na hliníkovou lištu 210-154; Šedá	<a href="http://www.wago.com/209-122">www.wago.com/209-122</a>
<b>Carrier rail</b>		
	<b>Obj. č.: 210-154</b> Hliníková nosná lišta; Délka 1000 mm; Šířka 18 mm; Výška 7 mm; Stříbrná	<a href="http://www.wago.com/210-154">www.wago.com/210-154</a>
<b>check</b>		
	<b>Obj. č.: 210-136</b> Zkušební hrot; Ø 2 mm; S 500mm vedením; Červená	<a href="http://www.wago.com/210-136">www.wago.com/210-136</a>
	<b>Obj. č.: 210-137</b> Zkušební hrot; Ø 2,3 mm; S 500mm vedením; Žlutá	<a href="http://www.wago.com/210-137">www.wago.com/210-137</a>
	<b>Obj. č.: 249-139</b> Modul pro zkušební zástrčku; Bez zajišťovacích západek; Možnost řadového připojení; Pro 4vodičové svorky; Šedá	<a href="http://www.wago.com/249-139">www.wago.com/249-139</a>

---

assembling

---



Obj. č.: 709-153

Krycí profil; Typ 1; Vhodný pro držák krycího profilu typu 1; Délka 1 m; Transparentní

[www.wago.com/709-153](http://www.wago.com/709-153)

---

**Ke stažení**

**Documentation**

**Additional Information**

Technical explanations	03-Apr-2019	pdf 2,1 MB	Stáhnout
------------------------	-------------	---------------	----------

---

**CAD/CAE-Data**

**CAD data**

2D/3D Models 264-260	URL	Stáhnout
----------------------	-----	----------

---

**CAE data**

EPLAN Data Portal 264-260	Stáhnout
---------------------------	----------

---

WSCAD Universe 264-260	Stáhnout
------------------------	----------

---

## Handling Instructions

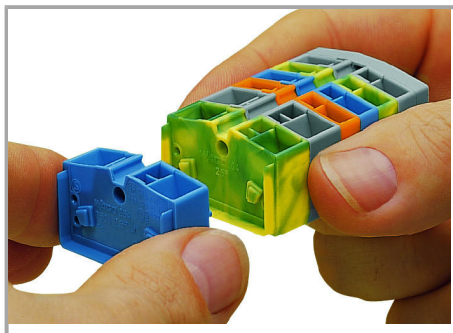

Assembling modular terminal blocks into terminal strips.

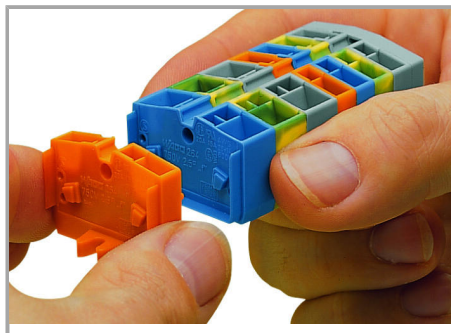

Mounting an "end terminal block" with mounting flange.

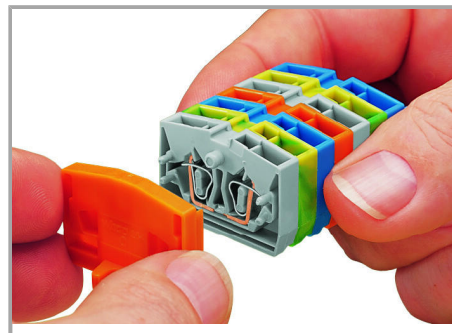

Mounting an end plate.

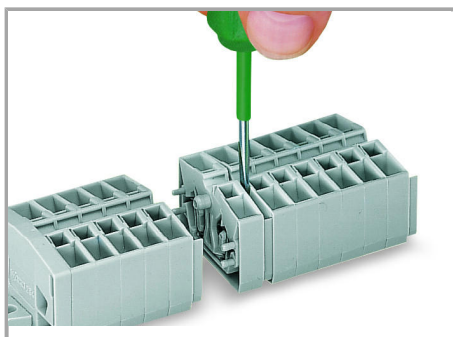

Removing a terminal block.

Změny vyhrazeny.

WAGO Elektro spol. sr. o.  
Rozvodova 1116/36  
143 00 Praha 12 - Modřany  
Tel.: +420 261 090 143  
Email: [info.cz@wago.com](mailto:info.cz@wago.com), [wago-cz@wago.com](mailto:wago-cz@wago.com)

Máte otázky ohledně našich produktů?  
Kdykoli nám zavolejte na číslo +420 261 090 143.



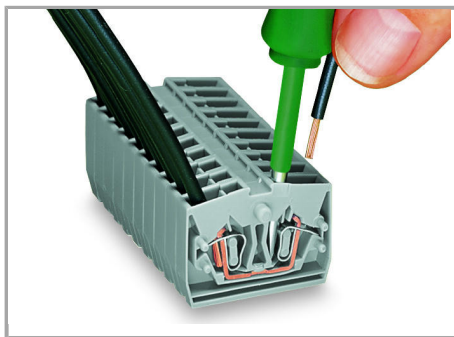

CAGE CLAMP® connection

Inserting a conductor.

With ferruled conductors, it is necessary to use a terminal block one size smaller than the conductor's nominal cross section.

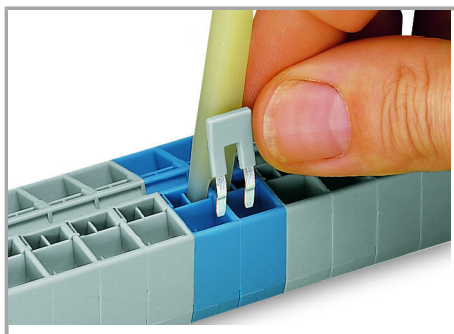

Commoning with comb-style jumper bar.

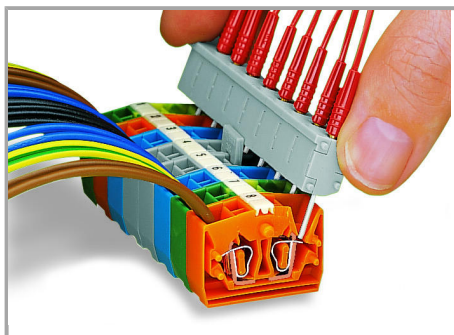

Testing by touch contact to the CAGE CLAMP® spring (limited to 0.5 A and 48 V test voltage) – test pins are not

protected against accidental contact.

WAGO Elektro spol. s r. o.

Rozvodova 1116/36

143 00 Praha 12 - Modřany

Tel.: +420 261 090 143

Email: [info.cz@wago.com](mailto:info.cz@wago.com), [wago-cz@wago.com](mailto:wago-cz@wago.com)

Máte otázky ohledně našich produktů?

Kdykoli nám zavolejte na číslo +420 261 090 143.



Testing via CAGE CLAMP® on the current bar  
(max. nominal current: 6 A).

CAGE CLAMP® clamps individual test  
contacts.

The maximum test voltage is 400 V.



Mounting and securing a terminal strip  
directly to the plate via screw-type flanges.

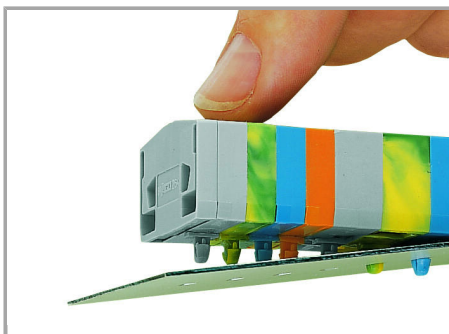

Mounting a terminal strip with snap-in feet  
into holes.

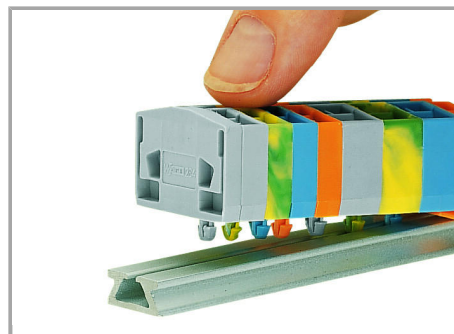

Mounting a terminal strip with snap-in feet  
onto aluminum rail.

Změny vyhrazeny.

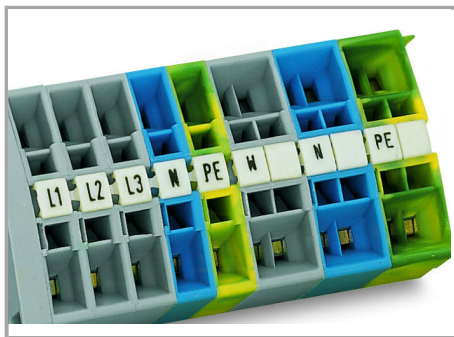

Combining 2- and 4-conductor terminal blocks.

Marking via Mini-WSB Quick markers.

Změny vyhrazeny.

---

WAGO Elektro spol. sr. o.  
Rozvodova 1116/36  
143 00 Praha 12 - Modřany  
Tel.: +420 261 090 143  
Email: [info.cz@wago.com](mailto:info.cz@wago.com), [wago-cz@wago.com](mailto:wago-cz@wago.com)

Máte otázky ohledně našich produktů?  
Kdykoli nám zavolejte na číslo +420 261 090 143.