

Datový list | Objednací číslo: 264-205

4vodičová svorkovnice; 5pól.; Bez tlačítka; S upevňovacími přírubami; Pro šroubové a podobné druhy upevnění; Upevňovací otvor Ø 3,2 mm; 2,5 mm²; CAGE CLAMP®; 2,50 mm²; Šedá

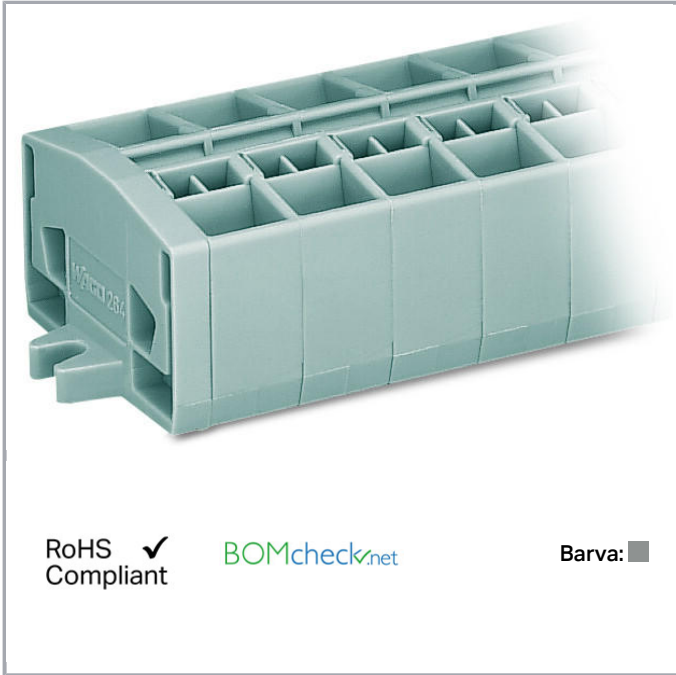

www.wago.com/264-205



RoHS
Compliant ✓

BOMcheck.net

Barva: ■

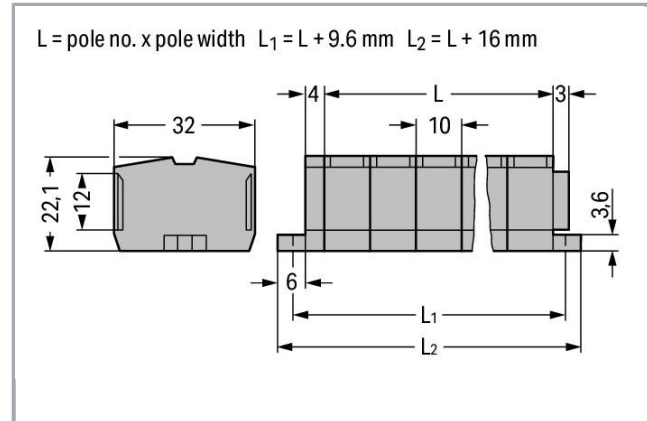

Data

Elektrické parametry

Ratings per IEC/EN 60664-1

Návrhové napětí (III / 3)	800 V
Návrhové rázové napětí (III / 3)	8 kV
Jmenovitý proud	24 A
Legenda (návrhové hodnoty)	(III / 3) ≙ kategorie přepětí III / stupeň znečištění 3

Údaje o připojení

Připojovací technika	CAGE CLAMP®
Způsob ovládání	Ovládací nástroj
Materiály připojitelných vodičů	Měď
Plný vodič	0,08 ... 2,5 mm ² / 28 ... 12 AWG
Jemně laněný vodič	0,08 ... 2,5 mm ² / 28 ... 12 AWG
Délka odizolování	8 ... 9 mm / 0.31 ... 0.35 palec
Počet pólů	5
Celkový počet kontaktních míst	20
Celkový počet potenciálů	5



Počet úrovní	1
Způsob zapojení	čelní připojení
Upozornění (průřez vodiče)	12 AWG: THHN, THWN

Geometrické údaje

Šířka	66 mm / 2.598 inch
Výška od povrchu	22,1 mm / 0.87 inch
Hloubka	32 mm / 1.26 inch
Šířka modulu	10 mm / 0.394 inch

Mechanické parametry

Provedení	Horizontální provedení
Způsob upevnění	Upevňovací příruba
Úroveň popisování	Středový popis



Údaje o materiálu

barva	Šedá
Požární zatížení	0.628 MJ
Hmotnost	33.3 g

Obchodní údaje

Druh balení	BOX
Country of origin	DE
GTIN	4044918418690
Customs Tariff No.	85369010000

Atesty/certifikáty**Specifické atesty jednotlivých států**

Logo	Schválení	Doplňkový text schválení	Název certifikátu
	CB DEKRA Certification B.V.	EN 60998	NL-49768
	CCA DEKRA Certification B.V.	EN 60998	2175624.01
	CCA DEKRA Certification B.V.	EN 60998	NTR NL-7342
	CSA DEKRA Certification B.V.	C22.2	70010891



Atesty pro použití v loďním průmyslu



Logo	Schválení	Doplňkový text schválení	Název certifikátu
	ABS American Bureau of Shipping	-	19- HG1869868- PDA
	DNV GL Det Norske Veritas, Germanischer Lloyd	-	TAE00001V2
	LR Lloyds Register	IEC 60998	91/20242 (E7)

Atesty UL



Logo	Schválení	Doplňkový text schválení	Název certifikátu
	UR Underwriters Laboratories Inc.	UL 1059	E45172, sec. 6



















Kompatibilní produkty











Jumper

	Obj. č.: 264-402 Vkládací můstek; Izolováno; 2x; Zmenšuje připojitelný průřez na 1,5 mm; Šedá	www.wago.com/264-402
	Obj. č.: 280-492 Hřebenový můstek ob svorku; Izolováno; 2x; IN = IN svorky; Šedá	www.wago.com/280-492













tools

	Obj. č.: 209-130 Ovládací nástroj; Vhodný pro řadu 264, 280, 281; 1x; Z izolačního materiálu	www.wago.com/209-130
	Obj. č.: 210-657 Ovládací nástroj; Břit: 3,5 x 0,5 mm; S částečně izolovanou rukojetí; Krátké	www.wago.com/210-657

	Obj. č.: 210-658 Ovládací nástroj; Břit: 3,5 × 0,5 mm; S částečně izolovanou rukojetí; Úhlové provedení; Krátké	www.wago.com/210-658
	Obj. č.: 210-720 Ovládací nástroj; Břit: 3,5 × 0,5 mm; S částečně izolovanou rukojetí	www.wago.com/210-720
	Obj. č.: 280-432 Ovládací nástroj; Z izolačního materiálu; 2×	www.wago.com/280-432
check		
	Obj. č.: 210-136 Zkušební hrot; Ø 2 mm; S 500mm vedením; Červená	www.wago.com/210-136
	Obj. č.: 210-137 Zkušební hrot; Ø 2,3 mm; S 500mm vedením; Žlutá	www.wago.com/210-137
	Obj. č.: 249-139 Modul pro zkušební zástrčku; Bez zajišťovacích západek; Možnost řadového připojení; Pro 4vodičové svorky; Šedá	www.wago.com/249-139
ferrule		
	Obj. č.: 216-101 Dutinka; Objímka na 0,5 mm ² / AWG 22; Bez plastového límce; Galvanicky pocínováno	www.wago.com/216-101
	Obj. č.: 216-102 Dutinka; Objímka na 0,75 mm ² / AWG 20; Bez plastového límce; Galvanicky pocínováno	www.wago.com/216-102
	Obj. č.: 216-103 Dutinka; Objímka na 1 mm ² / AWG 18; Bez plastového límce; Galvanicky pocínováno	www.wago.com/216-103
	Obj. č.: 216-104 Dutinka; Objímka na 1,5 mm ² / AWG 16; Bez plastového límce; Galvanicky pocínováno	www.wago.com/216-104
	Obj. č.: 216-106 Dutinka; Objímka na 2,5 mm ² / AWG 14; Bez plastového límce; Galvanicky pocínováno	www.wago.com/216-106
	Obj. č.: 216-121 Dutinka; Objímka na 0,5 mm ² / AWG 22; Bez plastového límce; Galvanicky pocínováno	www.wago.com/216-121
	Obj. č.: 216-122 Dutinka; Objímka na 0,75 mm ² / AWG 20; Bez plastového límce; Galvanicky pocínováno	www.wago.com/216-122
	Obj. č.: 216-123 Dutinka; Objímka na 1 mm ² / AWG 18; Bez plastového límce; Galvanicky pocínováno	www.wago.com/216-123
	Obj. č.: 216-124 Dutinka; Objímka na 1,5 mm ² / AWG 16; Bez plastového límce; Galvanicky pocínováno	www.wago.com/216-124
	Obj. č.: 216-131 Dutinka; Objímka na 0,25 mm ² / AWG 24; Bez plastového límce; Galvanicky pocínováno	www.wago.com/216-131
	Obj. č.: 216-132 Dutinka; Objímka na 0,34 mm ² / AWG 24; Bez plastového límce; Galvanicky pocínováno	www.wago.com/216-132
	Obj. č.: 216-151 Dutinka; Objímka na 0,25 mm ² / AWG 24; Bez plastového límce; Galvanicky pocínováno	www.wago.com/216-151
	Obj. č.: 216-152 Dutinka; Objímka na 0,34 mm ² / AWG 24; Bez plastového límce; Galvanicky pocínováno	www.wago.com/216-152

	Obj. č.: 216-201 Ferrule; Sleeve for 0.5 mm ² / 20 AWG; insulated; electro-tin plated; white	www.wago.com/216-201
	Obj. č.: 216-202 Ferrule; Sleeve for 0.75 mm ² / 18 AWG; insulated; electro-tin plated; gray	www.wago.com/216-202
	Obj. č.: 216-203 Dutinka; Objímka na 1 mm ² / AWG 18; S plastovým límcem; Galvanicky pocínováno; Červená	www.wago.com/216-203
	Obj. č.: 216-204 Dutinka; Objímka na 1,5 mm ² / AWG 16; S plastovým límcem; Galvanicky pocínováno; Černá	www.wago.com/216-204
	Obj. č.: 216-205 Dutinka; Objímka na 2,08 mm ² / AWG 14; S plastovým límcem; Galvanicky pocínováno; Žlutá	www.wago.com/216-205
	Obj. č.: 216-206 Dutinka; Objímka na 2,5 mm ² / AWG 14; S plastovým límcem; Galvanicky pocínováno; Modrá	www.wago.com/216-206
	Obj. č.: 216-221 Ferrule; Sleeve for 0.5 mm ² / 20 AWG; insulated; electro-tin plated; white	www.wago.com/216-221
	Obj. č.: 216-222 Ferrule; Sleeve for 0.75 mm ² / 18 AWG; insulated; electro-tin plated; gray	www.wago.com/216-222
	Obj. č.: 216-223 Dutinka; Objímka na 1 mm ² / AWG 18; S plastovým límcem; Galvanicky pocínováno; Červená	www.wago.com/216-223
	Obj. č.: 216-224 Dutinka; Objímka na 1,5 mm ² / AWG 16; S plastovým límcem; Galvanicky pocínováno; Černá	www.wago.com/216-224
	Obj. č.: 216-321 Dutinka; Objímka na 0,25 mm ² / AWG 24; S plastovým límcem; Galvanicky pocínováno; Žlutá	www.wago.com/216-321
	Obj. č.: 216-322 Ferrule; Sleeve for 0.34 mm ² / 22 AWG; insulated; electro-tin plated; green	www.wago.com/216-322
Marking accessories		
	Obj. č.: 2009-145 Mini-WSB Inline; Pro Smart Printer; Na cívce; Flexibilní, 5–5,2 mm; Bez potisku; Možnost naklapnutí; Bílá	www.wago.com/2009-145
	Obj. č.: 2009-145/000-002 Mini-WSB Inline; Pro Smart Printer; Na cívce; Flexibilní, 5–5,2 mm; Bez potisku; Možnost naklapnutí; Žlutá	www.wago.com/2009-145/000-002
	Obj. č.: 2009-145/000-005 Mini-WSB Inline; Pro Smart Printer; Na cívce; Flexibilní, 5–5,2 mm; Bez potisku; Možnost naklapnutí; Červená	www.wago.com/2009-145/000-005
	Obj. č.: 2009-145/000-006 Mini-WSB Inline; Pro Smart Printer; Na cívce; Flexibilní, 5–5,2 mm; Bez potisku; Možnost naklapnutí; Modrá	www.wago.com/2009-145/000-006
	Obj. č.: 2009-145/000-007 Mini-WSB Inline; Pro Smart Printer; Na cívce; Flexibilní, 5–5,2 mm; Bez potisku; Možnost naklapnutí; Šedá	www.wago.com/2009-145/000-007
	Obj. č.: 2009-145/000-012 Mini-WSB Inline; Pro Smart Printer; Na cívce; Flexibilní, 5–5,2 mm; Bez potisku; Možnost naklapnutí;	www.wago.com/2009-145/000-012

Oranžová

	Obj. č.: 2009-145/000-023 Mini-WSB Inline; Pro Smart Printer; Na cívice; Flexibilní, 5–5,2 mm; Bez potisku; Možnost naklapnutí; Zelená	www.wago.com/2009-145/000-023
	Obj. č.: 2009-145/000-024 Mini-WSB Inline; Pro Smart Printer; Na cívice; Flexibilní, 5–5,2 mm; Bez potisku; Možnost naklapnutí; Fialová	www.wago.com/2009-145/000-024
	Obj. č.: 209-290 Popisovací svazek; Neflexibilní; Bez potisku; Možnost naklapnutí; Bílá	www.wago.com/209-290
	Obj. č.: 248-501 Systém rychlého popisování Mini-WSB; Bez potisku; Šířka štítků 5 mm; 10 řad po 10 štítcích na každé kartě	www.wago.com/248-501
	Obj. č.: 248-501/000-002 Popisovací karta Mini-WSB; Jako karta; Neflexibilní; Bez potisku; Možnost naklapnutí; Žlutá	www.wago.com/248-501/000-002
	Obj. č.: 248-501/000-005 Popisovací karta Mini-WSB; Jako karta; Neflexibilní; Bez potisku; Možnost naklapnutí; Červená	www.wago.com/248-501/000-005
	Obj. č.: 248-501/000-006 Popisovací karta Mini-WSB; Jako karta; Neflexibilní; Bez potisku; Možnost naklapnutí; Modrá	www.wago.com/248-501/000-006
	Obj. č.: 248-501/000-007 Popisovací karta Mini-WSB; Jako karta; Neflexibilní; Bez potisku; Možnost naklapnutí; Šedá	www.wago.com/248-501/000-007
	Obj. č.: 248-501/000-012 Popisovací karta Mini-WSB; Jako karta; Neflexibilní; Bez potisku; Možnost naklapnutí; Oranžová	www.wago.com/248-501/000-012
	Obj. č.: 248-501/000-017 Popisovací karta Mini-WSB; Jako karta; Neflexibilní; Bez potisku; Možnost naklapnutí; Světle zelená	www.wago.com/248-501/000-017
	Obj. č.: 248-501/000-023 Popisovací karta Mini-WSB; Jako karta; Neflexibilní; Bez potisku; Možnost naklapnutí; Zelená	www.wago.com/248-501/000-023
	Obj. č.: 248-501/000-024 Popisovací karta Mini-WSB; Jako karta; Neflexibilní; Bez potisku; Možnost naklapnutí; Fialová	www.wago.com/248-501/000-024
assembling		
	Obj. č.: 709-153 Krycí profil; Typ 1; Vhodný pro držák krycího profilu typu 1; Délka 1 m; Transparentní	www.wago.com/709-153

Ke stažení

Documentation

Additional Information



Technical explanations

03-Apr-2019

pdf
2,1 MB

Stáhnout

CAD/CAE-Data

CAD data

2D/3D Models 264-205

URL

Stáhnout

CAE data

EPLAN Data Portal 264-205

Stáhnout

WSCAD Universe 264-205

Stáhnout

Handling Instructions

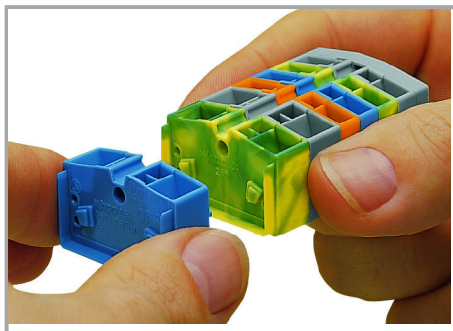

Assembling modular terminal blocks into terminal strips.

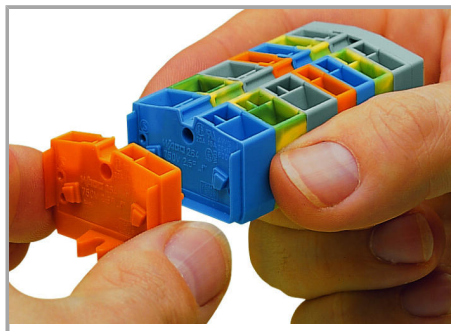

Mounting an "end terminal block" with mounting flange.

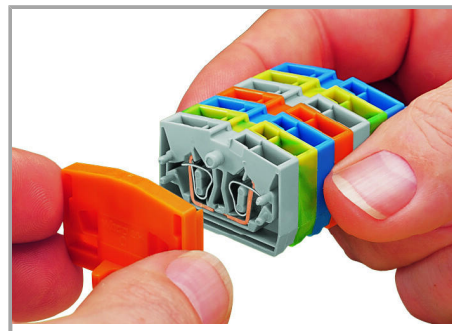

Mounting an end plate.

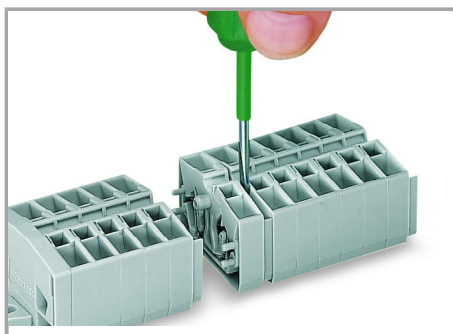

Removing a terminal block.

Změny vyhrazeny.

WAGO Elektro spol. sr. o.
Rozvodova 1116/36
143 00 Praha 12 - Modřany
Tel.: +420 261 090 143
Email: info.cz@wago.com, wago-cz@wago.com

Máte otázky ohledně našich produktů?
Kdykoli nám zavolejte na číslo +420 261 090 143.



CAGE CLAMP® connection

Inserting a conductor.

With ferruled conductors, it is necessary to use a terminal block one size smaller than the conductor's nominal cross section.



Commoning with comb-style jumper bar.



Testing by touch contact to the CAGE CLAMP® spring (limited to 0.5 A and 48 V test voltage) – test pins are not

protected against accidental contact.

WAGO Elektro spol. s r. o.

Rozvodova 1116/36

143 00 Praha 12 - Modřany

Tel.: +420 261 090 143

Email: info.cz@wago.com, wago-cz@wago.com

Máte otázky ohledně našich produktů?

Kdykoli nám zavolejte na číslo +420 261 090 143.



Testing via CAGE CLAMP® on the current bar
(max. nominal current: 6 A).

CAGE CLAMP® clamps individual test
contacts.

The maximum test voltage is 400 V.



Mounting and securing a terminal strip
directly to the plate via screw-type flanges.



Mounting a terminal strip with snap-in feet
into holes.



Mounting a terminal strip with snap-in feet
onto aluminum rail.

Změny vyhrazeny.

WAGO Elektro spol. sr. o.
Rozvodova 1116/36
143 00 Praha 12 - Modřany
Tel.: +420 261 090 143
Email: info.cz@wago.com, wago-cz@wago.com

Máte otázky ohledně našich produktů?
Kdykoli nám zavolejte na číslo +420 261 090 143.



Combining 2- and 4-conductor terminal blocks.

Marking via Mini-WSB Quick markers.

Změny vyhrazeny.

WAGO Elektro spol. sr. o.
Rozvodova 1116/36
143 00 Praha 12 - Modřany
Tel.: +420 261 090 143
Email: info.cz@wago.com, wago-cz@wago.com

Máte otázky ohledně našich produktů?
Kdykoli nám zavolejte na číslo +420 261 090 143.