

Datový list | Objednací číslo: 264-189

2vodičová svorkovnice; Vhodná pro aplikace Ex e II; 9pól.; Bez tlačítka; Se západkami; Pro plech o tloušťce 0,6–1,2 mm; Upevňovací otvor Ø 3,5 mm; 2,5 mm²; CAGE CLAMP®; 2,50 mm²; Světle šedá



www.wago.com/264-189



RoHS Compliant

[BOMcheck.net](https://www.bomcheck.net)

Barva:

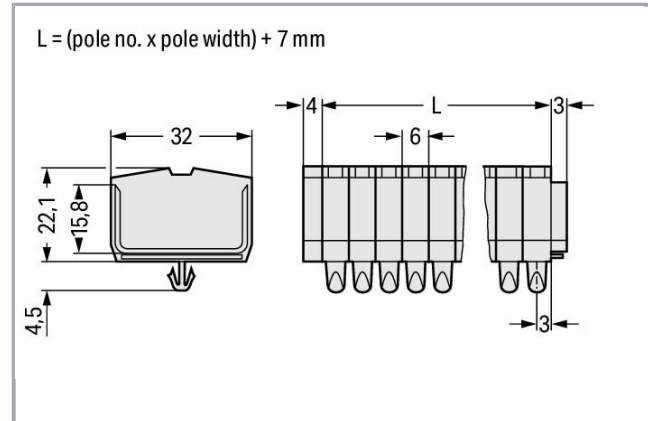

Data

Elektrické parametry

Approvals Ex

| | |
|-----------------------------------|-------|
| Jmenovité napětí dle EN (Ex e II) | 690 V |
| Jmenovitý proud (Ex e II) | 23 A |

Údaje o připojení

| | |
|---------------------------------|--|
| Připojovací technika | CAGE CLAMP® |
| Způsob ovládání | Ovládací nástroj |
| Materiály připojitelných vodičů | Měď |
| Plný vodič | 0,08 ... 2,5 mm ² / 28 ... 12 AWG |
| Jemně laněný vodič | 0,08 ... 2,5 mm ² / 28 ... 12 AWG |
| Délka odizolování | 8 ... 9 mm / 0.31 ... 0.35 palec |
| Počet pólů | 9 |
| Celkový počet kontaktních míst | 18 |
| Celkový počet potenciálů | 9 |
| Počet úrovní | 1 |

| | |
|----------------------------|--------------------|
| Způsob zapojení | čelní připojení |
| Upozornění (průřez vodiče) | 12 AWG: THHN, THWN |

Geometrické údaje

| | |
|------------------|---------------------|
| Šířka | 61 mm / 2.402 inch |
| Výška od povrchu | 22,1 mm / 0.87 inch |
| Hloubka | 32 mm / 1.26 inch |
| Šířka modulu | 6 mm / 0.236 inch |

Mechanické parametry

| | |
|-------------------|------------------------|
| Provedení | Horizontální provedení |
| Úroveň popisování | Středový popis |

Údaje o materiálu



| | |
|------------------|-------------|
| barva | Světle šedá |
| Požární zatížení | 0.722 MJ |
| Hmotnost | 37.771 g |

Obchodní údaje

| | |
|--------------------|-----------------------------|
| Product Group | 9 (Std. Chassis Mt. Blocks) |
| Druh balení | BOX |
| Country of origin | DE |
| GTIN | 4044918423328 |
| Customs Tariff No. | 85369010000 |

Atesty/certifikáty

Atesty pro použití v prostředí s nebezpečím výbuchu

| Logo | Schválení | Doplňkový text schválení | Název certifikátu |
|--|---|--------------------------|--|
|  | AEx UL International Germany GmbH c/o Physikalisch Technische Bundesanstalt | UL 60079 | E185892 |
|  | ATEX Physikalisch Technische Bundesanstalt (PTB) | EN 60079 | PTB 98 ATEX 3129 U (II 2 G/D EEx e II) |
|  | IECEX Physikalisch Technische Bundesanstalt (PTB) | IEC 60079 | IECEX PTB |

04.0003U
(Ex e IIC
Gb)

Specifické atesty jednotlivých států

| Logo | Schválení | Doplňkový text schválení | Název certifikátu |
|--|---------------------------------|--------------------------|-------------------|
|  | CSA DEKRA Certification B.V. | C22.2 | 70010891 |

Atesty pro použití v lodním průmyslu

| Logo | Schválení | Doplňkový text schválení | Název certifikátu |
|---|-----------------------|--------------------------|-------------------|
|  | LR Lloyds Register | IEC 60998 | 91/20242 (E7) |

Atesty UL

| Logo | Schválení | Doplňkový text schválení | Název certifikátu |
|--|--------------------------------------|--------------------------|-------------------|
|  | UR Underwriters Laboratories Inc. | UL 1059 | E45172, sec. 6 |

Kompatibilní produkty

check

| | | |
|--|---|--|
|  | Obj. č.: 249-136 Modul pro zkušební zástrčku; Bez zajišťovacích západek; Možnost řadového připojení; Pro 2vodičové svorky; Šedá | www.wago.com/249-136 |
|--|---|--|

General accessories

| | | |
|--|--|--|
|  | Obj. č.: 209-122 Plastová koncová svěrka; Možnost popisování systémem WSB; Na hliníkovou lištu 210-154; Šedá | www.wago.com/209-122 |
|--|--|--|

Jumper

| | | |
|--|---|--|
|  | Obj. č.: 264-402 Vkládací můstek; Izolováno; 2x; Zmenšuje připojitelný průřez na 1,5 mm; Šedá | www.wago.com/264-402 |
|--|---|--|

































Obj. č.: 281-492

















Hřebenový můstek ob svorku; Izolováno; 2x; IN = IN svorky; Šedá

www.wago.com/281-492

Marking accessories

| | | |
|--|---|--|
|  | Obj. č.: 2009-145 Mini-WSB Inline; Pro Smart Printer; Na cívce; Flexibilní, 5–5,2 mm; Bez potisku; Možnost naklapnutí; Bílá | www.wago.com/2009-145 |
|  | Obj. č.: 2009-145/000-002 Mini-WSB Inline; Pro Smart Printer; Na cívce; Flexibilní, 5–5,2 mm; Bez potisku; Možnost naklapnutí; Žlutá | www.wago.com/2009-145/000-002 |
|  | Obj. č.: 2009-145/000-005 Mini-WSB Inline; Pro Smart Printer; Na cívce; Flexibilní, 5–5,2 mm; Bez potisku; Možnost naklapnutí; Červená | www.wago.com/2009-145/000-005 |
|  | Obj. č.: 2009-145/000-006 Mini-WSB Inline; Pro Smart Printer; Na cívce; Flexibilní, 5–5,2 mm; Bez potisku; Možnost naklapnutí; Modrá | www.wago.com/2009-145/000-006 |
|  | Obj. č.: 2009-145/000-007 Mini-WSB Inline; Pro Smart Printer; Na cívce; Flexibilní, 5–5,2 mm; Bez potisku; Možnost naklapnutí; Šedá | www.wago.com/2009-145/000-007 |
|  | Obj. č.: 2009-145/000-012 Mini-WSB Inline; Pro Smart Printer; Na cívce; Flexibilní, 5–5,2 mm; Bez potisku; Možnost naklapnutí; Oranžová | www.wago.com/2009-145/000-012 |
|  | Obj. č.: 2009-145/000-023 Mini-WSB Inline; Pro Smart Printer; Na cívce; Flexibilní, 5–5,2 mm; Bez potisku; Možnost naklapnutí; Zelená | www.wago.com/2009-145/000-023 |
|  | Obj. č.: 2009-145/000-024 Mini-WSB Inline; Pro Smart Printer; Na cívce; Flexibilní, 5–5,2 mm; Bez potisku; Možnost naklapnutí; Fialová | www.wago.com/2009-145/000-024 |
|  | Obj. č.: 209-290 Popisovací svazek; Neflexibilní; Bez potisku; Možnost naklapnutí; Bílá | www.wago.com/209-290 |
|  | Obj. č.: 248-501 Systém rychlého popisování Mini-WSB; Bez potisku; Šířka štítků 5 mm; 10 řad po 10 štítcích na každé kartě | www.wago.com/248-501 |
|  | Obj. č.: 248-501/000-002 Popisovací karta Mini-WSB; Jako karta; Neflexibilní; Bez potisku; Možnost naklapnutí; Žlutá | www.wago.com/248-501/000-002 |
|  | Obj. č.: 248-501/000-005 Popisovací karta Mini-WSB; Jako karta; Neflexibilní; Bez potisku; Možnost naklapnutí; Červená | www.wago.com/248-501/000-005 |
|  | Obj. č.: 248-501/000-006 Popisovací karta Mini-WSB; Jako karta; Neflexibilní; Bez potisku; Možnost naklapnutí; Modrá | www.wago.com/248-501/000-006 |
|  | Obj. č.: 248-501/000-007 Popisovací karta Mini-WSB; Jako karta; Neflexibilní; Bez potisku; Možnost naklapnutí; Šedá | www.wago.com/248-501/000-007 |

| | | |
|--|--|--|
|  | Obj. č.: 248-501/000-012 Popisovací karta Mini-WSB; Jako karta; Neflexibilní; Bez potisku; Možnost naklapnutí; Oranžová | www.wago.com/248-501/000-012 |
|  | Obj. č.: 248-501/000-017 Popisovací karta Mini-WSB; Jako karta; Neflexibilní; Bez potisku; Možnost naklapnutí; Světle zelená | www.wago.com/248-501/000-017 |
|  | Obj. č.: 248-501/000-023 Popisovací karta Mini-WSB; Jako karta; Neflexibilní; Bez potisku; Možnost naklapnutí; Zelená | www.wago.com/248-501/000-023 |
|  | Obj. č.: 248-501/000-024 Popisovací karta Mini-WSB; Jako karta; Neflexibilní; Bez potisku; Možnost naklapnutí; Fialová | www.wago.com/248-501/000-024 |
| assembling | | |
|  | Obj. č.: 709-153 Krycí profil; Typ 1; Vhodný pro držák krycího profilu typu 1; Délka 1 m; Transparentní | www.wago.com/709-153 |
| Carrier rail | | |
|  | Obj. č.: 210-154 Hliníková nosná lišta; Délka 1000 mm; Šířka 18 mm; Výška 7 mm; Stříbrná | www.wago.com/210-154 |
| ferrule | | |
|  | Obj. č.: 216-101 Dutinka; Objímka na 0,5 mm ² / AWG 22; Bez plastového límce; Galvanicky pocínováno | www.wago.com/216-101 |
|  | Obj. č.: 216-102 Dutinka; Objímka na 0,75 mm ² / AWG 20; Bez plastového límce; Galvanicky pocínováno | www.wago.com/216-102 |
|  | Obj. č.: 216-103 Dutinka; Objímka na 1 mm ² / AWG 18; Bez plastového límce; Galvanicky pocínováno | www.wago.com/216-103 |
|  | Obj. č.: 216-104 Dutinka; Objímka na 1,5 mm ² / AWG 16; Bez plastového límce; Galvanicky pocínováno | www.wago.com/216-104 |
|  | Obj. č.: 216-106 Dutinka; Objímka na 2,5 mm ² / AWG 14; Bez plastového límce; Galvanicky pocínováno | www.wago.com/216-106 |
|  | Obj. č.: 216-121 Dutinka; Objímka na 0,5 mm ² / AWG 22; Bez plastového límce; Galvanicky pocínováno | www.wago.com/216-121 |
|  | Obj. č.: 216-122 Dutinka; Objímka na 0,75 mm ² / AWG 20; Bez plastového límce; Galvanicky pocínováno | www.wago.com/216-122 |
|  | Obj. č.: 216-123 Dutinka; Objímka na 1 mm ² / AWG 18; Bez plastového límce; Galvanicky pocínováno | www.wago.com/216-123 |
|  | Obj. č.: 216-124 Dutinka; Objímka na 1,5 mm ² / AWG 16; Bez plastového límce; Galvanicky pocínováno | www.wago.com/216-124 |
|  | Obj. č.: 216-131 Dutinka; Objímka na 0,25 mm ² / AWG 24; Bez plastového límce; Galvanicky pocínováno | www.wago.com/216-131 |
|  | Obj. č.: 216-132 Dutinka; Objímka na 0,34 mm ² / AWG 24; Bez plastového límce; Galvanicky pocínováno | www.wago.com/216-132 |
| | Obj. č.: 216-151 | |

| | | |
|--|--|--|
|  | Dutinka; Objímka na 0,25 mm ² / AWG 24; Bez plastového límce; Galvanicky pocínováno | www.wago.com/216-151 |
|  | Obj. č.: 216-152 Dutinka; Objímka na 0,34 mm ² / AWG 24; Bez plastového límce; Galvanicky pocínováno | www.wago.com/216-152 |
|  | Obj. č.: 216-201 Ferrule; Sleeve for 0.5 mm ² / 20 AWG; insulated; electro-tin plated; white | www.wago.com/216-201 |
|  | Obj. č.: 216-202 Ferrule; Sleeve for 0.75 mm ² / 18 AWG; insulated; electro-tin plated; gray | www.wago.com/216-202 |
|  | Obj. č.: 216-203 Dutinka; Objímka na 1 mm ² / AWG 18; S plastovým límcem; Galvanicky pocínováno; Červená | www.wago.com/216-203 |
|  | Obj. č.: 216-204 Dutinka; Objímka na 1,5 mm ² / AWG 16; S plastovým límcem; Galvanicky pocínováno; Černá | www.wago.com/216-204 |
|  | Obj. č.: 216-205 Dutinka; Objímka na 2,08 mm ² / AWG 14; S plastovým límcem; Galvanicky pocínováno; Žlutá | www.wago.com/216-205 |
|  | Obj. č.: 216-206 Dutinka; Objímka na 2,5 mm ² / AWG 14; S plastovým límcem; Galvanicky pocínováno; Modrá | www.wago.com/216-206 |
|  | Obj. č.: 216-221 Ferrule; Sleeve for 0.5 mm ² / 20 AWG; insulated; electro-tin plated; white | www.wago.com/216-221 |
|  | Obj. č.: 216-222 Ferrule; Sleeve for 0.75 mm ² / 18 AWG; insulated; electro-tin plated; gray | www.wago.com/216-222 |
|  | Obj. č.: 216-223 Dutinka; Objímka na 1 mm ² / AWG 18; S plastovým límcem; Galvanicky pocínováno; Červená | www.wago.com/216-223 |
|  | Obj. č.: 216-224 Dutinka; Objímka na 1,5 mm ² / AWG 16; S plastovým límcem; Galvanicky pocínováno; Černá | www.wago.com/216-224 |
| | Obj. č.: 216-321 Dutinka; Objímka na 0,25 mm ² / AWG 24; S plastovým límcem; Galvanicky pocínováno; Žlutá | www.wago.com/216-321 |
|  | Obj. č.: 216-322 Ferrule; Sleeve for 0.34 mm ² / 22 AWG; insulated; electro-tin plated; green | www.wago.com/216-322 |
| tools | | |
|  | Obj. č.: 209-130 Ovládací nástroj; Vhodný pro řadu 264, 280, 281; 1×; Z izolačního materiálu | www.wago.com/209-130 |
|  | Obj. č.: 210-657 Ovládací nástroj; Břit: 3,5 × 0,5 mm; S částečně izolovanou rukojetí; Krátké | www.wago.com/210-657 |
|  | Obj. č.: 210-658 Ovládací nástroj; Břit: 3,5 × 0,5 mm; S částečně izolovanou rukojetí; Úhlové provedení; Krátké | www.wago.com/210-658 |
|  | Obj. č.: 210-720 Ovládací nástroj; Břit: 3,5 × 0,5 mm; S částečně izolovanou rukojetí | www.wago.com/210-720 |
|  | Obj. č.: 280-432 Ovládací nástroj; Z izolačního materiálu; 2× | www.wago.com/280-432 |



Ke stažení

Documentation

Additional Information

| | | | |
|------------------------|-------------|---------------|----------|
| Technical explanations | 03-Apr-2019 | pdf 2,1 MB | Stáhnout |
|------------------------|-------------|---------------|----------|

CAD/CAE-Data

CAD data

| | | | |
|----------------------|--|-----|----------|
| 2D/3D Models 264-189 | | URL | Stáhnout |
|----------------------|--|-----|----------|

CAE data

| | | | |
|---------------------------|--|--|----------|
| EPLAN Data Portal 264-189 | | | Stáhnout |
|---------------------------|--|--|----------|

| | | | |
|------------------------|--|--|----------|
| WSCAD Universe 264-189 | | | Stáhnout |
|------------------------|--|--|----------|

Handling Instructions

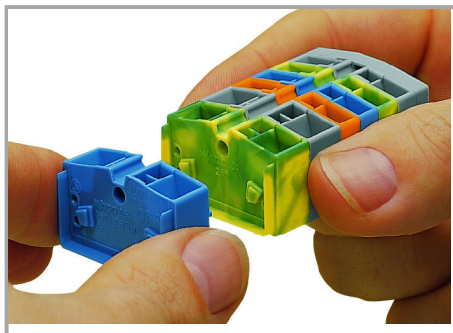

Assembling modular terminal blocks into terminal strips.

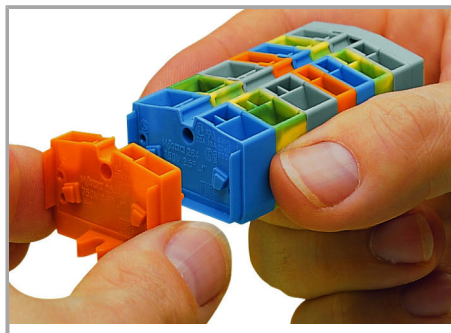

Mounting an "end terminal block" with mounting flange.

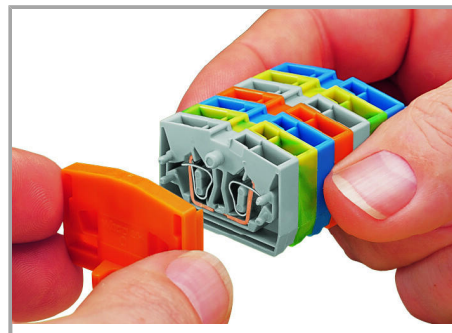

Mounting an end plate.



Removing a terminal block.

Změny vyhrazeny.

WAGO Elektro spol. sr. o.
Rozvodova 1116/36
143 00 Praha 12 - Modřany
Tel.: +420 261 090 143
Email: info.cz@wago.com, wago-cz@wago.com

Máte otázky ohledně našich produktů?
Kdykoli nám zavolejte na číslo +420 261 090 143.

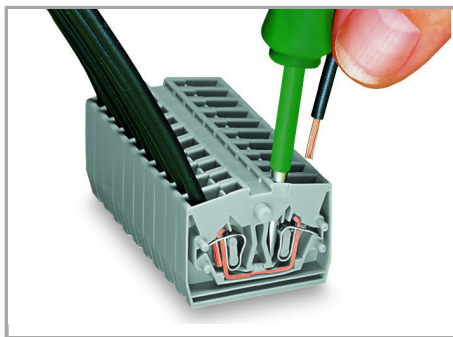

CAGE CLAMP® connection

Inserting a conductor.

With ferruled conductors, it is necessary to use a terminal block one size smaller than the conductor's nominal cross section.

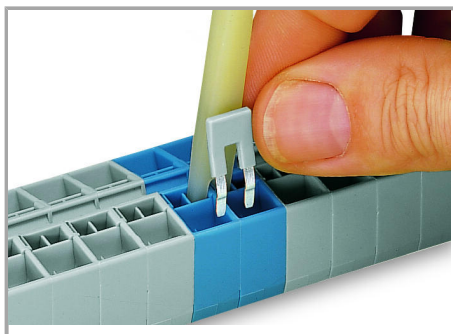

Commoning with comb-style jumper bar.

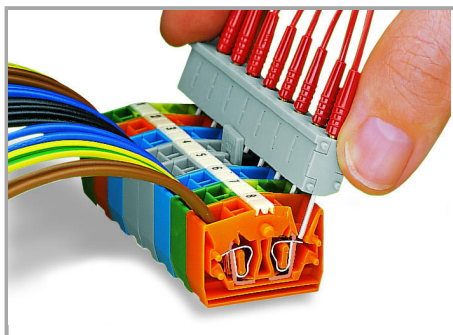

Testing by touch contact to the CAGE CLAMP® spring (limited to 0.5 A and 48 V test voltage) – test pins are not

protected against accidental contact.

WAGO Elektro spol. s r. o.

Rozvodova 1116/36

143 00 Praha 12 - Modřany

Tel.: +420 261 090 143

Email: info.cz@wago.com, wago-cz@wago.com

Máte otázky ohledně našich produktů?

Kdykoli nám zavolejte na číslo +420 261 090 143.



Testing via CAGE CLAMP® on the current bar
(max. nominal current: 6 A).

CAGE CLAMP® clamps individual test
contacts.

The maximum test voltage is 400 V.



Mounting and securing a terminal strip
directly to the plate via screw-type flanges.



Mounting a terminal strip with snap-in feet
into holes.



Mounting a terminal strip with snap-in feet
onto aluminum rail.

Změny vyhrazeny.

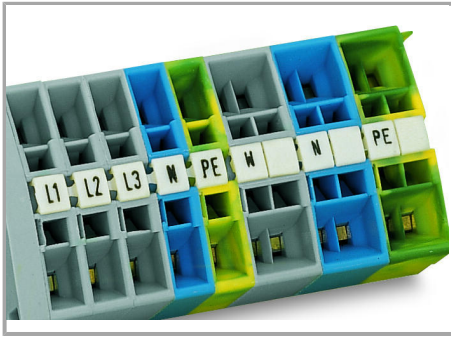

Combining 2- and 4-conductor terminal blocks.

Marking via Mini-WSB Quick markers.

Změny vyhrazeny.

WAGO Elektro spol. sr. o.
Rozvodova 1116/36
143 00 Praha 12 - Modřany
Tel.: +420 261 090 143
Email: info.cz@wago.com, wago-cz@wago.com

Máte otázky ohledně našich produktů?
Kdykoli nám zavolejte na číslo +420 261 090 143.