

Datový list | Objednací číslo: 769-237

Základní svorka PE – 1 vodič / 1 pin; Na DIN lištu 35 × 15 a 35 × 7,5; 4 mm²;
CAGE CLAMP®; 4,00 mm²; Zeleno-žlutá

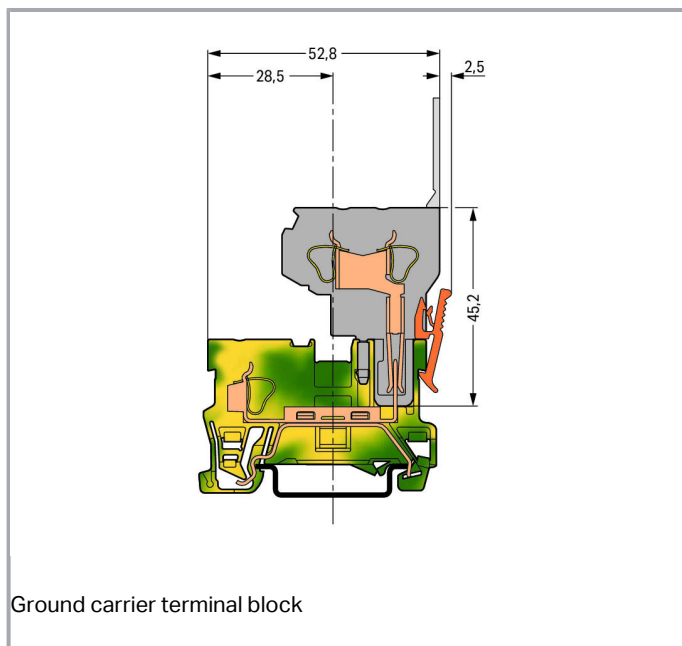

www.wago.com/769-237

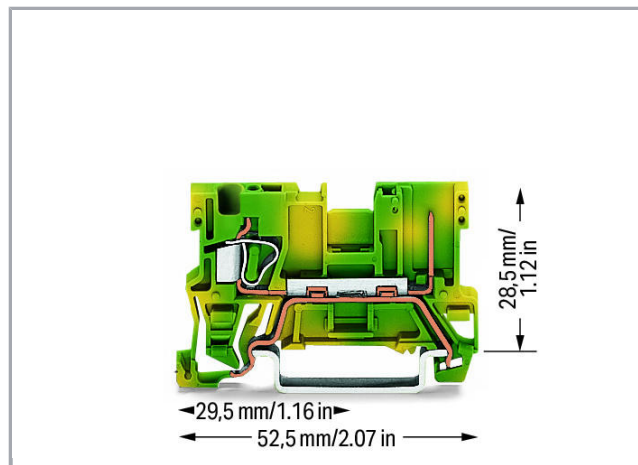

Data

Údaje o připojení

Připojovací technika

CAGE CLAMP®



Způsob ovládání	Ovládací nástroj
Materiály připojitelných vodičů	Měď
Jmenovitý průřez	4 mm ²
Plný vodič	0,08 ... 4 mm ² / 28 ... 12 AWG
Jemně laněný vodič	0,08 ... 4 mm ² / 28 ... 12 AWG
Délka odizolování	8 ... 9 mm / 0.31 ... 0.35 palec
Celkový počet kontaktních míst	2
Celkový počet potenciálů	1
Počet úrovní	1
Způsob zapojení	čelní připojení

Geometrické údaje

Šířka	5 mm / 0.197 inch
Výška od horní hrany lišty DIN 35	28,5 mm / 1.122 inch
Hloubka	52,5 mm / 2.067 inch

Mechanické parametry

Provedení	Horizontální provedení
Způsob montáže	Lišta DIN 35
Úroveň popisování	Středový popis

Údaje o materiálu

barva	Zeleno-žlutá
Izolační materiál	Polyamid 66 (PA 66)
Požární zatížení	0.101 MJ
Hmotnost	6.831 g

Obchodní údaje



Product Group	18 (X-COM-System)
Druh balení	BOX
Country of origin	DE
GTIN	4044918827843
Customs Tariff No.	85366990990

Atesty/certifikáty



Specifické atesty jednotlivých států

Logo	Schválení	Doplňkový text schválení	Název certifikátu
	CCA DEKRA Certification B.V.	EN 60947	NTR NL- 7626



CCA

	CSA DEKRA Certification B.V.	C22.2 No. 158	1101144
	KEMA/KEUR DEKRA Certification B.V.	EN 60947	2190419.01

Atesty pro použití v lodním průmyslu













Logo	Schválení	Doplňkový text schválení	Název certifikátu
	ABS American Bureau of Shipping	EN 60947	14-HG1293677-PDA
	DNV GL Det Norske Veritas, Germanischer Lloyd	-	TAE00001V2
	LR Lloyds Register	EN 60947	91/20112 (E9)

Atesty UL

Logo	Schválení	Doplňkový text schválení	Název certifikátu
	UR Underwriters Laboratories Inc.	UL 1977	E45171-20010720
	UR Underwriters Laboratories Inc.	UL 1059	20190731-E45172

Kompatibilní produkty

Marking accessories

	Obj. č.: 2009-145 Mini-WSB Inline; Pro Smart Printer; Na cívce; Flexibilní, 5–5,2 mm; Bez potisku; Možnost naklapnutí; Bílá	www.wago.com/2009-145
	Obj. č.: 2009-145/000-002 Mini-WSB Inline; Pro Smart Printer; Na cívce; Flexibilní, 5–5,2 mm; Bez potisku; Možnost naklapnutí; Žlutá	www.wago.com/2009-145/000-002
	Obj. č.: 2009-145/000-005 Mini-WSB Inline; Pro Smart Printer; Na cívce; Flexibilní, 5–5,2 mm; Bez potisku; Možnost naklapnutí; Červená	www.wago.com/2009-145/000-005
	Obj. č.: 2009-145/000-006 Mini-WSB Inline; Pro Smart Printer; Na cívce; Flexibilní, 5–5,2 mm; Bez potisku; Možnost naklapnutí; Modrá	www.wago.com/2009-145/000-006
	Obj. č.: 2009-145/000-007 Mini-WSB Inline; Pro Smart Printer; Na cívce; Flexibilní, 5–5,2 mm; Bez potisku; Možnost naklapnutí; Šedá	www.wago.com/2009-145/000-007
	Obj. č.: 2009-145/000-012 Mini-WSB Inline; Pro Smart Printer; Na cívce; Flexibilní, 5–5,2 mm; Bez potisku; Možnost naklapnutí; Oranžová	www.wago.com/2009-145/000-012
	Obj. č.: 2009-145/000-023 Mini-WSB Inline; Pro Smart Printer; Na cívce; Flexibilní, 5–5,2 mm; Bez potisku; Možnost naklapnutí; Zelená	www.wago.com/2009-145/000-023
	Obj. č.: 2009-145/000-024 Mini-WSB Inline; Pro Smart Printer; Na cívce; Flexibilní, 5–5,2 mm; Bez potisku; Možnost naklapnutí; Fialová	www.wago.com/2009-145/000-024
	Obj. č.: 248-501 Systém rychlého popisování Mini-WSB; Bez potisku; Šířka štítků 5 mm; 10 řad po 10 štítcích na každé kartě	www.wago.com/248-501
	Obj. č.: 248-501/000-002 Popisovací karta Mini-WSB; Jako karta; Neflexibilní; Bez potisku; Možnost naklapnutí; Žlutá	www.wago.com/248-501/000-002
	Obj. č.: 248-501/000-005 Popisovací karta Mini-WSB; Jako karta; Neflexibilní; Bez potisku; Možnost naklapnutí; Červená	www.wago.com/248-501/000-005
	Obj. č.: 248-501/000-006 Popisovací karta Mini-WSB; Jako karta; Neflexibilní; Bez potisku; Možnost naklapnutí; Modrá	www.wago.com/248-501/000-006

**Obj. č.: 248-501/000-007**

Popisovací karta Mini-WSB; Jako karta; Neflexibilní; Bez potisku; Možnost naklapnutí; Šedá

www.wago.com/248-501/000-007**Obj. č.: 248-501/000-012**

Popisovací karta Mini-WSB; Jako karta; Neflexibilní; Bez potisku; Možnost naklapnutí; Oranžová

www.wago.com/248-501/000-012**Obj. č.: 248-501/000-017**

Popisovací karta Mini-WSB; Jako karta; Neflexibilní; Bez potisku; Možnost naklapnutí; Světle zelená

www.wago.com/248-501/000-017**Obj. č.: 248-501/000-023**

Popisovací karta Mini-WSB; Jako karta; Neflexibilní; Bez potisku; Možnost naklapnutí; Zelená















www.wago.com/248-501/000-023**Obj. č.: 248-501/000-024**

















Popisovací karta Mini-WSB; Jako karta; Neflexibilní; Bez potisku; Možnost naklapnutí; Fialová

















www.wago.com/248-501/000-024**ferrule****Obj. č.: 216-101**Dutinka; Objímka na 0,5 mm² / AWG 22; Bez plastového límce; Galvanicky pocínovánowww.wago.com/216-101**Obj. č.: 216-102**Dutinka; Objímka na 0,75 mm² / AWG 20; Bez plastového límce; Galvanicky pocínovánowww.wago.com/216-102**Obj. č.: 216-103**Dutinka; Objímka na 1 mm² / AWG 18; Bez plastového límce; Galvanicky pocínovánowww.wago.com/216-103**Obj. č.: 216-104**Dutinka; Objímka na 1,5 mm² / AWG 16; Bez plastového límce; Galvanicky pocínovánowww.wago.com/216-104**Obj. č.: 216-201**Ferrule; Sleeve for 0.5 mm² / 20 AWG; insulated; electro-tin plated; whitewww.wago.com/216-201**Obj. č.: 216-202**Ferrule; Sleeve for 0.75 mm² / 18 AWG; insulated; electro-tin plated; graywww.wago.com/216-202**Obj. č.: 216-203**Dutinka; Objímka na 1 mm² / AWG 18; S plastovým límcem; Galvanicky pocínováno; Červenáwww.wago.com/216-203**Obj. č.: 216-204**Dutinka; Objímka na 1,5 mm² / AWG 16; S plastovým límcem; Galvanicky pocínováno; Černáwww.wago.com/216-204**Obj. č.: 216-206**Dutinka; Objímka na 2,5 mm² / AWG 14; S plastovým límcem; Galvanicky pocínováno; Modráwww.wago.com/216-206**Obj. č.: 216-301**Dutinka; Objímka na 0,25 mm² / AWG 24; S plastovým límcem; Galvanicky pocínováno; Žlutáwww.wago.com/216-301**Obj. č.: 216-302**Ferrule; Sleeve for 0.34 mm² / 22 AWG; insulated; electro-tin plated; greenwww.wago.com/216-302**tools****Obj. č.: 210-720**

















Ovládací nástroj; Břit: 3,5 × 0,5 mm; S částečně izolovanou rukojetí















www.wago.com/210-720**Carrier rail**















	Obj. č.: 210-112 Ocelová nosná lišta; 35 × 7,5 mm; Tloušťka 1 mm; Délka 2 m; Děrovaná; Dle normy EN 60715; Šířka otvorů 25 mm; vzdálenost mezi otvory 36 mm	www.wago.com/210-112
	Obj. č.: 210-113 Ocelová nosná lišta; 35 × 7,5 mm; Tloušťka 1 mm; Délka 2 m; Neděrovaná; Dle normy EN 60715	www.wago.com/210-113
	Obj. č.: 210-114 Ocelová nosná lišta; 35 × 15 mm; Tloušťka 1,5 mm; Délka 2 m; Neděrovaná; Podobné EN 60715	www.wago.com/210-114
	Obj. č.: 210-115 Ocelová nosná lišta; 35 × 7,5 mm; Tloušťka 1 mm; Délka 2 m; Děrovaná; Dle normy EN 60715; Šířka otvorů 18 mm; vzdálenost mezi otvory 25 mm	www.wago.com/210-115
	Obj. č.: 210-118 Ocelová nosná lišta; 35 × 15 mm; Tloušťka 2,3 mm; Délka 2 m; Neděrovaná; Dle normy EN 60715	www.wago.com/210-118
	Obj. č.: 210-196 Hliníková nosná lišta; 35 × 8,2 mm; Tloušťka 1,6 mm; Délka 2 m; Neděrovaná; Podobné EN 60715; Stříbrná	www.wago.com/210-196
	Obj. č.: 210-197 Ocelová nosná lišta; 35 × 15 mm; Tloušťka 1,5 mm; Délka 2 m; Děrovaná; Podobné EN 60715	www.wago.com/210-197
	Obj. č.: 210-198 Měděná nosná lišta; 35 × 15 mm; Tloušťka 2,3 mm; Délka 2 m; Neděrovaná; Dle normy EN 60715; Měděná	www.wago.com/210-198
	Obj. č.: 210-504 Ocelová nosná lišta; 35 × 7,5 mm; Tloušťka 1 mm; Délka 2 m; Děrovaná; Pásově zinkováno; Dle normy EN 60715	www.wago.com/210-504
	Obj. č.: 210-505 Ocelová nosná lišta; 35 × 7,5 mm; Tloušťka 1 mm; Délka 2 m; Neděrovaná; Pásově zinkováno; Dle normy EN 60715	www.wago.com/210-505
	Obj. č.: 210-506 Ocelová nosná lišta; 35 × 15 mm; Tloušťka 1,5 mm; Délka 2 m; Neděrovaná; Pásově zinkováno; Podobné EN 60715	www.wago.com/210-506
	Obj. č.: 210-508 Ocelová nosná lišta; 35 × 15 mm; Tloušťka 1,5 mm; Délka 2 m; Děrovaná; Pásově zinkováno; Podobné EN 60715	www.wago.com/210-508
End plate		
	Obj. č.: 769-307 Koncová bočnice a separátor; Tloušťka 1,1 mm; Šedá	www.wago.com/769-307
	Obj. č.: 769-308 Koncová bočnice a separátor; Tloušťka 1,1 mm; Oranžová	www.wago.com/769-308
Protective Warning Marker		
	Obj. č.: 280-415 Výstražný kryt; S černým symbolem blesku; Pro 5 svorek; Žlutá	www.wago.com/280-415
General accessories		
	Obj. č.: 280-404 Zkušební adaptér; Šířka 5 mm; Pro zkušební hrot 210-137 (Ø 2,3 mm); Vhodná pro svorky 1,5–4 mm ² ; Šedá	www.wago.com/280-404
	Obj. č.: 280-418 Modul pro zkušební zástrčku; Možnost řadového připojení; Vhodný ke všem řadovým svorkám WAGO řad 280 a 780 s drážkou pro můstek v napájecí liště; Šedá	www.wago.com/280-418















	Obj. č.: 280-419 Slepý modul; Možnost řadového připojení; K přeskočení svorek; Šedá	www.wago.com/280-419
	Obj. č.: 769-438 Kryt kolíků; S držákem značení pro Mini-WSB; Šedá	www.wago.com/769-438
	Obj. č.: 769-439 Kryt kolíků; S držákem značení pro Mini-WSB; Oranžová	www.wago.com/769-439
	Obj. č.: 769-501 1vodičový počáteční modul s pružinovou svorkovnicí; S integrovanou koncovou bočnicí; 4 mm ² ; 1pól.; 4,00 mm ² ; Šedá	www.wago.com/769-501
	Obj. č.: 769-501/000-006 1vodičový počáteční modul s pružinovou svorkovnicí; 4 mm ² ; 1pól.; 4,00 mm ² ; Modrá	www.wago.com/769-501/000-006
	Obj. č.: 769-501/000-016 1vodičový počáteční modul s pružinovou svorkovnicí; S integrovanou koncovou bočnicí; 4 mm ² ; 1pól.; 4,00 mm ² ; Zeleno-žlutá	www.wago.com/769-501/000-016
	Obj. č.: 769-502 1vodičový středový modul s pružinovou svorkovnicí; 4 mm ² ; 1pól.; 4,00 mm ² ; Šedá	www.wago.com/769-502
	Obj. č.: 769-502/000-006 1vodičový středový modul s pružinovou svorkovnicí; 4 mm ² ; 1pól.; 4,00 mm ² ; Modrá	www.wago.com/769-502/000-006
	Obj. č.: 769-502/000-016 1vodičový středový modul s pružinovou svorkovnicí; 4 mm ² ; 1pól.; 4,00 mm ² ; Zeleno-žlutá	www.wago.com/769-502/000-016
	Obj. č.: 769-503 1vodičový koncový modul s pružinovou svorkovnicí; 4 mm ² ; 1pól.; 4,00 mm ² ; Šedá	www.wago.com/769-503
	Obj. č.: 769-503/000-006 1vodičový koncový modul s pružinovou svorkovnicí; 4 mm ² ; 1pól.; 4,00 mm ² ; Modrá	www.wago.com/769-503/000-006
	Obj. č.: 769-503/000-016 1vodičový koncový modul s pružinovou svorkovnicí; 4 mm ² ; 1pól.; 4,00 mm ² ; Zeleno-žlutá	www.wago.com/769-503/000-016
	Obj. č.: 769-504 2vodičový počáteční modul s pružinovou svorkovnicí; S integrovanou koncovou bočnicí; 4 mm ² ; 1pól.; 4,00 mm ² ; Šedá	www.wago.com/769-504
	Obj. č.: 769-504/000-006 2vodičový počáteční modul s pružinovou svorkovnicí; S integrovanou koncovou bočnicí; 4 mm ² ; 1pól.; 4,00 mm ² ; Modrá	www.wago.com/769-504/000-006
	Obj. č.: 769-504/000-016 2vodičový počáteční modul s pružinovou svorkovnicí; 4 mm ² ; 1pól.; 4,00 mm ² ; Zeleno-žlutá	www.wago.com/769-504/000-016
	Obj. č.: 769-505 2vodičový středový modul s pružinovou svorkovnicí; 4 mm ² ; 1pól.; 4,00 mm ² ; Šedá	www.wago.com/769-505

	Obj. č.: 769-505/000-006 2vodičový středový modul s pružinovou svorkovnicí; 4 mm ² ; 1pól.; 4,00 mm ² ; Modrá	www.wago.com/769-505/000-006
	Obj. č.: 769-505/000-016 2vodičový středový modul s pružinovou svorkovnicí; 4 mm ² ; 1pól.; 4,00 mm ² ; Zeleno-žlutá	www.wago.com/769-505/000-016
	Obj. č.: 769-506 2vodičový koncový modul s pružinovou svorkovnicí; 4 mm ² ; 1pól.; 4,00 mm ² ; Šedá	www.wago.com/769-506
	Obj. č.: 769-506/000-006 2vodičový koncový modul s pružinovou svorkovnicí; 4 mm ² ; 1pól.; 4,00 mm ² ; Modrá	www.wago.com/769-506/000-006
	Obj. č.: 769-506/000-016 2vodičový koncový modul s pružinovou svorkovnicí; 4 mm ² ; 1pól.; 4,00 mm ² ; Zeleno-žlutá	www.wago.com/769-506/000-016
	Obj. č.: 769-512 1vodičový počáteční modul s pružinovou svorkovnicí; Úhlové provedení; 4 mm ² ; 1pól.; 4,00 mm ² ; Šedá	www.wago.com/769-512
	Obj. č.: 769-512/000-006 1vodičový počáteční modul s pružinovou svorkovnicí; Úhlové provedení; 4 mm ² ; 1pól.; 4,00 mm ² ; Modrá	www.wago.com/769-512/000-006
	Obj. č.: 769-512/000-016 1vodičový počáteční modul s pružinovou svorkovnicí; Úhlové provedení; 4 mm ² ; 1pól.; 4,00 mm ² ; Zeleno-žlutá	www.wago.com/769-512/000-016
	Obj. č.: 769-513 1vodičový středový modul s pružinovou svorkovnicí; Úhlové provedení; 4 mm ² ; 1pól.; 4,00 mm ² ; Šedá	www.wago.com/769-513
	Obj. č.: 769-513/000-006 1vodičový středový modul s pružinovou svorkovnicí; Úhlové provedení; 4 mm ² ; 1pól.; 4,00 mm ² ; Modrá	www.wago.com/769-513/000-006
	Obj. č.: 769-513/000-016 1vodičový středový modul s pružinovou svorkovnicí; Úhlové provedení; 4 mm ² ; 1pól.; 4,00 mm ² ; Zeleno-žlutá	www.wago.com/769-513/000-016
	Obj. č.: 769-515 1vodičový koncový modul s pružinovou svorkovnicí; Úhlové provedení; 4 mm ² ; 1pól.; 4,00 mm ² ; Šedá	www.wago.com/769-515
	Obj. č.: 769-515/000-006 1vodičový koncový modul s pružinovou svorkovnicí; Úhlové provedení; 4 mm ² ; 1pól.; 4,00 mm ² ; Modrá	www.wago.com/769-515/000-006
	Obj. č.: 769-515/000-016 1vodičový koncový modul s pružinovou svorkovnicí; Úhlové provedení; 4 mm ² ; 1pól.; 4,00 mm ² ; Zeleno-žlutá	www.wago.com/769-515/000-016
Insulation stop		
	Obj. č.: 769-470 Izolační zarážka; 0,08–0,2 mm ² „e“ (0,14 mm ² „f“); 5 ks/pás; Bílá	www.wago.com/769-470
	Obj. č.: 769-471 Izolační zarážka; 0,25–0,5 mm ² ; 5 ks/pás; Světle šedá	www.wago.com/769-471

	Obj. č.: 769-472 Izolační zarážka; 0,75–1 mm ² ; 5 ks/pás; Tmavě šedá	www.wago.com/769-472
check		
	Obj. č.: 210-136 Zkušební hrot; Ø 2 mm; S 500mm vedením; Červená	www.wago.com/210-136
	Obj. č.: 210-137 Zkušební hrot; Ø 2,3 mm; S 500mm vedením; Žlutá	www.wago.com/210-137
assembling		
	Obj. č.: 209-106 Držák; K izolované montáži nosných lišt DIN 35; Šedá	www.wago.com/209-106
Coding		
	Obj. č.: 769-435 Kódovací kolík; Ke kódování pružinových svorkovnic; Pro základní svorky / konektory s pájecími piny; Oranžová	www.wago.com/769-435
Jumper		
	Obj. č.: 249-123 Vodičový můstek; Izolováno; L = 180 mm; Průřez vedení 0,75 mm ²	www.wago.com/249-123
	Obj. č.: 249-125 Vodičový můstek; Izolováno; L = 60 mm; Průřez vedení 0,75 mm ²	www.wago.com/249-125
	Obj. č.: 249-126 Vodičový můstek; Izolováno; L = 110 mm; Průřez vedení 0,75 mm ²	www.wago.com/249-126
	Obj. č.: 249-127 Vodičový můstek; Izolováno; L = 250 mm; Průřez vedení 0,75 mm ²	www.wago.com/249-127
	Obj. č.: 280-402 Příčný můstek; Izolováno; IN = IN svorky; Šedá	www.wago.com/280-402
	Obj. č.: 280-409 Příčný můstek ob svorku; Izolováno; IN = IN svorky; Šedá	www.wago.com/280-409
	Obj. č.: 280-422 Příčný můstek; Izolováno; IN = IN svorky; Žlutozelená	www.wago.com/280-422
	Obj. č.: 780-452 Stupňovitý můstek; Izolováno; Z 1 na 2; Rozteč 5 mm; Vhodný pro 2vodičové pružinové svorkovnice; Šedá	www.wago.com/780-452
	Obj. č.: 780-453 Stupňovitý můstek; Izolováno; z 1 na 3; Rozteč 5 mm; Vhodný pro 2vodičové pružinové svorkovnice; Šedá	www.wago.com/780-453
	Obj. č.: 780-454 Stupňovitý můstek; Izolováno; Z 1 na 4; Rozteč 5 mm; Vhodný pro 2vodičové pružinové svorkovnice; Šedá	www.wago.com/780-454
	Obj. č.: 780-455 Stupňovitý můstek; Izolováno; Z 1 na 5; Rozteč 5 mm; Vhodný pro 2vodičové pružinové svorkovnice; Šedá	www.wago.com/780-455
	Obj. č.: 780-456 Stupňovitý můstek; Izolováno; Z 1 na 6; Rozteč 5 mm; Vhodný pro 2vodičové pružinové svorkovnice; Šedá	www.wago.com/780-456
	Obj. č.: 780-457	

	Stupňovitý můstek; Izolováno; Z 1 na 7; Rozteč 5 mm; Vhodný pro 2vodičové pružinové svorkovnice; Šedá	www.wago.com/780-457
	Obj. č.: 780-458 Stupňovitý můstek; Izolováno; Z 1 na 8; Rozteč 5 mm; Vhodný pro 2vodičové pružinové svorkovnice; Šedá	www.wago.com/780-458
Female plug		
	Obj. č.: 769-101 1vodičová pružinová svorkovnice; 4 mm ² ; 1pól.; 4,00 mm ² ; Šedá	www.wago.com/769-101
	Obj. č.: 769-101/000-006 1vodičová pružinová svorkovnice; 4 mm ² ; 1pól.; 4,00 mm ² ; Modrá	www.wago.com/769-101/000-006
	Obj. č.: 769-101/000-016 1vodičová pružinová svorkovnice; 4 mm ² ; 1pól.; 4,00 mm ² ; Zeleno-žlutá	www.wago.com/769-101/000-016
	Obj. č.: 769-101/022-000 1vodičová pružinová svorkovnice; Úhlové provedení; 4 mm ² ; 1pól.; 4,00 mm ² ; Šedá	www.wago.com/769-101/022-000
	Obj. č.: 769-101/022-016 1vodičová pružinová svorkovnice; Úhlové provedení; 4 mm ² ; 1pól.; 4,00 mm ² ; Zeleno-žlutá	www.wago.com/769-101/022-016
	Obj. č.: 769-102 1vodičová pružinová svorkovnice; 4 mm ² ; 2pól.; 4,00 mm ² ; Šedá	www.wago.com/769-102
	Obj. č.: 769-102/000-006 1vodičová pružinová svorkovnice; 4 mm ² ; 2pól.; 4,00 mm ² ; Modrá	www.wago.com/769-102/000-006
	Obj. č.: 769-102/000-036 1vodičová pružinová svorkovnice; 4 mm ² ; 2pól.; 4,00 mm ² ; Šedá / zelená – žlutá	www.wago.com/769-102/000-036
	Obj. č.: 769-102/000-037 1vodičová pružinová svorkovnice; 4 mm ² ; 2pól.; 4,00 mm ² ; Zelená – žlutá / šedá	www.wago.com/769-102/000-037
	Obj. č.: 769-102/022-000 1vodičová pružinová svorkovnice; Úhlové provedení; 4 mm ² ; 2pól.; 4,00 mm ² ; Šedá	www.wago.com/769-102/022-000
	Obj. č.: 769-103 1vodičová pružinová svorkovnice; 4 mm ² ; 3pól.; 4,00 mm ² ; Šedá	www.wago.com/769-103
	Obj. č.: 769-103/000-006 1vodičová pružinová svorkovnice; 4 mm ² ; 3pól.; 4,00 mm ² ; Modrá	www.wago.com/769-103/000-006
	Obj. č.: 769-103/000-036 1vodičová pružinová svorkovnice; 4 mm ² ; 3pól.; 4,00 mm ² ; Šedá / zelená – žlutá	www.wago.com/769-103/000-036

	Obj. č.: 769-103/000-037 1 vodičová pružinová svorkovnice; 4 mm ² ; 3pól.; 4,00 mm ² ; Zelená – žlutá / šedá	www.wago.com/769-103/000-037
	Obj. č.: 769-103/000-038 1 vodičová pružinová svorkovnice; 4 mm ² ; 3pól.; 4,00 mm ² ; Šedá / modrá / zelená – žlutá	www.wago.com/769-103/000-038
	Obj. č.: 769-103/000-039 1 vodičová pružinová svorkovnice; 4 mm ² ; 3pól.; 4,00 mm ² ; Zelená – žlutá, modrá, šedá	www.wago.com/769-103/000-039
	Obj. č.: 769-103/022-000 1 vodičová pružinová svorkovnice; Úhlové provedení; 4 mm ² ; 3pól.; 4,00 mm ² ; Šedá	www.wago.com/769-103/022-000
	Obj. č.: 769-104 1 vodičová pružinová svorkovnice; 4 mm ² ; 4pól.; 4,00 mm ² ; Šedá	www.wago.com/769-104
	Obj. č.: 769-104/000-006 1 vodičová pružinová svorkovnice; 4 mm ² ; 4pól.; 4,00 mm ² ; Modrá	www.wago.com/769-104/000-006
	Obj. č.: 769-104/000-036 1 vodičová pružinová svorkovnice; 4 mm ² ; 4pól.; 4,00 mm ² ; Šedá / zelená – žlutá	www.wago.com/769-104/000-036
	Obj. č.: 769-104/000-037 1 vodičová pružinová svorkovnice; 4 mm ² ; 4pól.; 4,00 mm ² ; Zelená – žlutá / šedá	www.wago.com/769-104/000-037
	Obj. č.: 769-104/000-038 1 vodičová pružinová svorkovnice; 4 mm ² ; 4pól.; 4,00 mm ² ; Šedá / modrá / zelená – žlutá	www.wago.com/769-104/000-038
	Obj. č.: 769-104/000-039 1 vodičová pružinová svorkovnice; 4 mm ² ; 4pól.; 4,00 mm ² ; Zelená – žlutá, modrá, šedá	www.wago.com/769-104/000-039
	Obj. č.: 769-104/022-000 1 vodičová pružinová svorkovnice; Úhlové provedení; 4 mm ² ; 4pól.; 4,00 mm ² ; Šedá	www.wago.com/769-104/022-000
	Obj. č.: 769-105 1 vodičová pružinová svorkovnice; 4 mm ² ; 5pól.; 4,00 mm ² ; Šedá	www.wago.com/769-105
	Obj. č.: 769-105/000-006 1 vodičová pružinová svorkovnice; 4 mm ² ; 5pól.; 4,00 mm ² ; Modrá	www.wago.com/769-105/000-006
	Obj. č.: 769-105/000-036 1 vodičová pružinová svorkovnice; 4 mm ² ; 5pól.; 4,00 mm ² ; Šedá / zelená – žlutá	www.wago.com/769-105/000-036
	Obj. č.: 769-105/000-037 1 vodičová pružinová svorkovnice; 4 mm ² ; 5pól.; 4,00 mm ² ; Zelená – žlutá / šedá	www.wago.com/769-105/000-037

	Obj. č.: 769-105/000-038 1 vodičová pružinová svorkovnice; 4 mm ² ; 5pól.; 4,00 mm ² ; Šedá / modrá / zelená – žlutá	www.wago.com/769-105/000-038
	Obj. č.: 769-105/000-039 1 vodičová pružinová svorkovnice; 4 mm ² ; 5pól.; 4,00 mm ² ; Zelená – žlutá, modrá, šedá	www.wago.com/769-105/000-039
	Obj. č.: 769-105/022-000 1 vodičová pružinová svorkovnice; Úhlové provedení; 4 mm ² ; 5pól.; 4,00 mm ² ; Šedá	www.wago.com/769-105/022-000
	Obj. č.: 769-106 1 vodičová pružinová svorkovnice; 4 mm ² ; 6pól.; 4,00 mm ² ; Šedá	www.wago.com/769-106
	Obj. č.: 769-106/000-006 1 vodičová pružinová svorkovnice; 4 mm ² ; 6pól.; 4,00 mm ² ; Modrá	www.wago.com/769-106/000-006
	Obj. č.: 769-106/000-036 1 vodičová pružinová svorkovnice; 4 mm ² ; 6pól.; 4,00 mm ² ; Šedá / zelená – žlutá	www.wago.com/769-106/000-036
	Obj. č.: 769-106/000-037 1 vodičová pružinová svorkovnice; 4 mm ² ; 6pól.; 4,00 mm ² ; Zelená – žlutá / šedá	www.wago.com/769-106/000-037
	Obj. č.: 769-106/000-038 1 vodičová pružinová svorkovnice; 4 mm ² ; 6pól.; 4,00 mm ² ; Šedá / modrá / zelená – žlutá	www.wago.com/769-106/000-038
	Obj. č.: 769-106/000-039 1 vodičová pružinová svorkovnice; 4 mm ² ; 6pól.; 4,00 mm ² ; Zelená – žlutá, modrá, šedá	www.wago.com/769-106/000-039
	Obj. č.: 769-106/022-000 1 vodičová pružinová svorkovnice; Úhlové provedení; 4 mm ² ; 6pól.; 4,00 mm ² ; Šedá	www.wago.com/769-106/022-000
	Obj. č.: 769-107 1 vodičová pružinová svorkovnice; 4 mm ² ; 7pól.; 4,00 mm ² ; Šedá	www.wago.com/769-107
	Obj. č.: 769-107/000-006 1 vodičová pružinová svorkovnice; 4 mm ² ; 7pól.; 4,00 mm ² ; Modrá	www.wago.com/769-107/000-006
	Obj. č.: 769-107/000-036 1 vodičová pružinová svorkovnice; 4 mm ² ; 7pól.; 4,00 mm ² ; Šedá / zelená – žlutá	www.wago.com/769-107/000-036
	Obj. č.: 769-107/000-037 1 vodičová pružinová svorkovnice; 4 mm ² ; 7pól.; 4,00 mm ² ; Zelená – žlutá / šedá	www.wago.com/769-107/000-037
	Obj. č.: 769-107/000-038 1 vodičová pružinová svorkovnice; 4 mm ² ; 7pól.; 4,00 mm ² ; Šedá / modrá / zelená – žlutá	www.wago.com/769-107/000-038



Obj. č.: 769-107/000-039

1 vodičová pružinová svorkovnice; 4 mm²; 7pól.; 4,00 mm²; Zelená – žlutá, modrá, šedá

www.wago.com/769-107/000-039



Obj. č.: 769-107/022-000

1 vodičová pružinová svorkovnice; Úhlové provedení; 4 mm²; 7pól.; 4,00 mm²; Šedá

www.wago.com/769-107/022-000



Obj. č.: 769-108

1 vodičová pružinová svorkovnice; 4 mm²; 8pól.; 4,00 mm²; Šedá

www.wago.com/769-108



Obj. č.: 769-108/000-006

1 vodičová pružinová svorkovnice; 4 mm²; 8pól.; 4,00 mm²; Modrá

www.wago.com/769-108/000-006



Obj. č.: 769-108/000-036

1 vodičová pružinová svorkovnice; 4 mm²; 8pól.; 4,00 mm²; Šedá / zelená – žlutá

www.wago.com/769-108/000-036



Obj. č.: 769-108/000-037

1 vodičová pružinová svorkovnice; 4 mm²; 8pól.; 4,00 mm²; Zelená – žlutá / šedá

www.wago.com/769-108/000-037



Obj. č.: 769-108/000-038

1 vodičová pružinová svorkovnice; 4 mm²; 8pól.; 4,00 mm²; Šedá / modrá / zelená – žlutá

www.wago.com/769-108/000-038



Obj. č.: 769-108/000-039

1 vodičová pružinová svorkovnice; 4 mm²; 8pól.; 4,00 mm²; Zelená – žlutá, modrá, šedá

www.wago.com/769-108/000-039



Obj. č.: 769-108/022-000

1 vodičová pružinová svorkovnice; Úhlové provedení; 4 mm²; 8pól.; 4,00 mm²; Šedá

www.wago.com/769-108/022-000



Obj. č.: 769-109

1 vodičová pružinová svorkovnice; 4 mm²; 9pól.; 4,00 mm²; Šedá

www.wago.com/769-109



Obj. č.: 769-109/000-006

1 vodičová pružinová svorkovnice; 4 mm²; 9pól.; 4,00 mm²; Modrá

www.wago.com/769-109/000-006



Obj. č.: 769-109/000-036

1 vodičová pružinová svorkovnice; 4 mm²; 9pól.; 4,00 mm²; Šedá / zelená – žlutá

www.wago.com/769-109/000-036



Obj. č.: 769-109/000-037

1 vodičová pružinová svorkovnice; 4 mm²; 9pól.; 4,00 mm²; Zelená – žlutá / šedá

www.wago.com/769-109/000-037



Obj. č.: 769-109/000-038

1 vodičová pružinová svorkovnice; 4 mm²; 9pól.; 4,00 mm²; Šedá / modrá / zelená – žlutá















www.wago.com/769-109/000-038



Obj. č.: 769-109/000-039

1 vodičová pružinová svorkovnice; 4 mm²; 9pól.; 4,00 mm²; Zelená – žlutá, modrá, šedá

www.wago.com/769-109/000-039

	Obj. č.: 769-109/022-000 1vodičová pružinová svorkovnice; Úhlové provedení; 4 mm ² ; 9pól.; 4,00 mm ² ; Šedá	www.wago.com/769-109/022-000
	Obj. č.: 769-110 1vodičová pružinová svorkovnice; 4 mm ² ; 10pól.; 4,00 mm ² ; Šedá	www.wago.com/769-110
	Obj. č.: 769-110/000-006 1vodičová pružinová svorkovnice; 4 mm ² ; 10pól.; 4,00 mm ² ; Modrá	www.wago.com/769-110/000-006
	Obj. č.: 769-110/000-036 1vodičová pružinová svorkovnice; 4 mm ² ; 10pól.; 4,00 mm ² ; Šedá / zelená – žlutá	www.wago.com/769-110/000-036
	Obj. č.: 769-110/000-037 1vodičová pružinová svorkovnice; 4 mm ² ; 10pól.; 4,00 mm ² ; Zelená – žlutá / šedá	www.wago.com/769-110/000-037
	Obj. č.: 769-110/000-038 1vodičová pružinová svorkovnice; 4 mm ² ; 10pól.; 4,00 mm ² ; Šedá / modrá / zelená – žlutá	www.wago.com/769-110/000-038
	Obj. č.: 769-110/000-039 1vodičová pružinová svorkovnice; 4 mm ² ; 10pól.; 4,00 mm ² ; Zelená – žlutá, modrá, šedá	www.wago.com/769-110/000-039
	Obj. č.: 769-110/022-000 1vodičová pružinová svorkovnice; Úhlové provedení; 4 mm ² ; 10pól.; 4,00 mm ² ; Šedá	www.wago.com/769-110/022-000
	Obj. č.: 769-111 1vodičová pružinová svorkovnice; 4 mm ² ; 11pól.; 4,00 mm ² ; Šedá	www.wago.com/769-111
	Obj. č.: 769-111/000-006 1vodičová pružinová svorkovnice; 4 mm ² ; 11pól.; 4,00 mm ² ; Modrá	www.wago.com/769-111/000-006
	Obj. č.: 769-111/000-036 1vodičová pružinová svorkovnice; 4 mm ² ; 11pól.; 4,00 mm ² ; Šedá / zelená – žlutá	www.wago.com/769-111/000-036
	Obj. č.: 769-111/000-037 1vodičová pružinová svorkovnice; 4 mm ² ; 11pól.; 4,00 mm ² ; Zelená – žlutá / šedá	www.wago.com/769-111/000-037
	Obj. č.: 769-111/000-038 1vodičová pružinová svorkovnice; 4 mm ² ; 11pól.; 4,00 mm ² ; Šedá / modrá / zelená – žlutá	www.wago.com/769-111/000-038
	Obj. č.: 769-111/000-039 1vodičová pružinová svorkovnice; 4 mm ² ; 11pól.; 4,00 mm ² ; Zelená – žlutá, modrá, šedá	www.wago.com/769-111/000-039
	Obj. č.: 769-111/022-000 1vodičová pružinová svorkovnice; Úhlové provedení; 4 mm ² ; 11pól.; 4,00 mm ² ; Šedá	www.wago.com/769-111/022-000
	Obj. č.: 769-112	



1 vodičová pružinová svorkovnice; 4 mm²; 12pól.; 4,00 mm²; Šedá

www.wago.com/769-112



Obj. č.: 769-112/000-006

1 vodičová pružinová svorkovnice; 4 mm²; 12pól.; 4,00 mm²; Modrá

www.wago.com/769-112/000-006



Obj. č.: 769-112/000-036

1 vodičová pružinová svorkovnice; 4 mm²; 12pól.; 4,00 mm²; Šedá / zelená – žlutá

www.wago.com/769-112/000-036



Obj. č.: 769-112/000-037

1 vodičová pružinová svorkovnice; 4 mm²; 12pól.; 4,00 mm²; Zelená – žlutá / šedá

www.wago.com/769-112/000-037



Obj. č.: 769-112/000-038

1 vodičová pružinová svorkovnice; 4 mm²; 12pól.; 4,00 mm²; Šedá / modrá / zelená – žlutá

www.wago.com/769-112/000-038



Obj. č.: 769-112/000-039

1 vodičová pružinová svorkovnice; 4 mm²; 12pól.; 4,00 mm²; Zelená – žlutá, modrá, šedá

www.wago.com/769-112/000-039



Obj. č.: 769-112/022-000

1 vodičová pružinová svorkovnice; Úhlové provedení; 4 mm²; 12pól.; 4,00 mm²; Šedá

www.wago.com/769-112/022-000



Obj. č.: 769-113

1 vodičová pružinová svorkovnice; 4 mm²; 13pól.; 4,00 mm²; Šedá

www.wago.com/769-113



Obj. č.: 769-113/000-036

1 vodičová pružinová svorkovnice; 4 mm²; 13pól.; 4,00 mm²; Šedá / zelená – žlutá

www.wago.com/769-113/000-036



Obj. č.: 769-113/000-037

1 vodičová pružinová svorkovnice; 4 mm²; 13pól.; 4,00 mm²; Zelená – žlutá / šedá

www.wago.com/769-113/000-037



Obj. č.: 769-113/000-038

1 vodičová pružinová svorkovnice; 4 mm²; 13pól.; 4,00 mm²; Šedá / modrá / zelená – žlutá

www.wago.com/769-113/000-038



Obj. č.: 769-113/000-039

1 vodičová pružinová svorkovnice; 4 mm²; 13pól.; 4,00 mm²; Zelená – žlutá, modrá, šedá

www.wago.com/769-113/000-039



Obj. č.: 769-113/022-000

1 vodičová pružinová svorkovnice; Úhlové provedení; 4 mm²; 13pól.; 4,00 mm²; Šedá

www.wago.com/769-113/022-000



Obj. č.: 769-114

1 vodičová pružinová svorkovnice; 4 mm²; 14pól.; 4,00 mm²; Šedá

















www.wago.com/769-114













Obj. č.: 769-114/000-006

1 vodičová pružinová svorkovnice; 4 mm²; 14pól.; 4,00 mm²; Modrá

www.wago.com/769-114/000-006

	Obj. č.: 769-114/000-036 1 vodičová pružinová svorkovnice; 4 mm ² ; 14pól.; 4,00 mm ² ; Šedá / zelená – žlutá	www.wago.com/769-114/000-036
	Obj. č.: 769-114/000-037 1 vodičová pružinová svorkovnice; 4 mm ² ; 14pól.; 4,00 mm ² ; Zelená – žlutá / šedá	www.wago.com/769-114/000-037
	Obj. č.: 769-114/000-038 1 vodičová pružinová svorkovnice; 4 mm ² ; 14pól.; 4,00 mm ² ; Šedá / modrá / zelená – žlutá	www.wago.com/769-114/000-038
	Obj. č.: 769-114/000-039 1 vodičová pružinová svorkovnice; 4 mm ² ; 14pól.; 4,00 mm ² ; Zelená – žlutá, modrá, šedá	www.wago.com/769-114/000-039
	Obj. č.: 769-114/022-000 1 vodičová pružinová svorkovnice; Úhlové provedení; 4 mm ² ; 14pól.; 4,00 mm ² ; Šedá	www.wago.com/769-114/022-000
	Obj. č.: 769-115 1 vodičová pružinová svorkovnice; 4 mm ² ; 15pól.; 4,00 mm ² ; Šedá	www.wago.com/769-115
	Obj. č.: 769-115/000-036 1 vodičová pružinová svorkovnice; 4 mm ² ; 15pól.; 4,00 mm ² ; Šedá / zelená – žlutá	www.wago.com/769-115/000-036
	Obj. č.: 769-115/000-037 1 vodičová pružinová svorkovnice; 4 mm ² ; 15pól.; 4,00 mm ² ; Zelená – žlutá / šedá	www.wago.com/769-115/000-037
	Obj. č.: 769-115/000-038 1 vodičová pružinová svorkovnice; 4 mm ² ; 15pól.; 4,00 mm ² ; Šedá / modrá / zelená – žlutá	www.wago.com/769-115/000-038
	Obj. č.: 769-115/000-039 1 vodičová pružinová svorkovnice; 4 mm ² ; 15pól.; 4,00 mm ² ; Zelená – žlutá, modrá, šedá	www.wago.com/769-115/000-039
	Obj. č.: 769-115/022-000 1 vodičová pružinová svorkovnice; Úhlové provedení; 4 mm ² ; 15pól.; 4,00 mm ² ; Šedá	www.wago.com/769-115/022-000
	Obj. č.: 769-121 2 vodičová pružinová svorkovnice; 4 mm ² ; 1pól.; 4,00 mm ² ; Šedá	www.wago.com/769-121
	Obj. č.: 769-121/000-016 2 vodičová pružinová svorkovnice; 4 mm ² ; 1pól.; 4,00 mm ² ; Zeleno-žlutá	www.wago.com/769-121/000-016
	Obj. č.: 769-122 2 vodičová pružinová svorkovnice; 4 mm ² ; 2pól.; 4,00 mm ² ; Šedá	www.wago.com/769-122
	Obj. č.: 769-123 2 vodičová pružinová svorkovnice; 4 mm ² ; 3pól.; 4,00 mm ² ; Šedá	www.wago.com/769-123
	Obj. č.: 769-124 2 vodičová pružinová svorkovnice; 4 mm ² ; 4pól.; 4,00 mm ² ; Šedá	www.wago.com/769-124

	Obj. č.: 769-125 2vodičová pružinová svorkovnice; 4 mm ² ; 5pól.; 4,00 mm ² ; Šedá	www.wago.com/769-125
	Obj. č.: 769-126 2vodičová pružinová svorkovnice; 4 mm ² ; 6pól.; 4,00 mm ² ; Šedá	www.wago.com/769-126
	Obj. č.: 769-127 2vodičová pružinová svorkovnice; 4 mm ² ; 7pól.; 4,00 mm ² ; Šedá	www.wago.com/769-127
	Obj. č.: 769-128 2vodičová pružinová svorkovnice; 4 mm ² ; 8pól.; 4,00 mm ² ; Šedá	www.wago.com/769-128
	Obj. č.: 769-129 2vodičová pružinová svorkovnice; 4 mm ² ; 9pól.; 4,00 mm ² ; Šedá	www.wago.com/769-129
	Obj. č.: 769-130 2vodičová pružinová svorkovnice; 4 mm ² ; 10pól.; 4,00 mm ² ; Šedá	www.wago.com/769-130
	Obj. č.: 769-131 2vodičová pružinová svorkovnice; 4 mm ² ; 11pól.; 4,00 mm ² ; Šedá	www.wago.com/769-131
	Obj. č.: 769-132 2vodičová pružinová svorkovnice; 4 mm ² ; 12pól.; 4,00 mm ² ; Šedá	www.wago.com/769-132
	Obj. č.: 769-133 2vodičová pružinová svorkovnice; 4 mm ² ; 13pól.; 4,00 mm ² ; Šedá	www.wago.com/769-133
	Obj. č.: 769-134 2vodičová pružinová svorkovnice; 4 mm ² ; 14pól.; 4,00 mm ² ; Šedá	www.wago.com/769-134
	Obj. č.: 769-135 2vodičová pružinová svorkovnice; 4 mm ² ; 15pól.; 4,00 mm ² ; Šedá	www.wago.com/769-135

Ke stažení

Documentation

Additional Information

Technical explanations	03-Apr-2019	pdf 2,1 MB	Stáhnout
------------------------	-------------	---------------	----------

CAD/CAE-Data

CAD data

2D/3D Models 769-237	URL	Stáhnout
----------------------	-----	----------

CAE data

EPLAN Data Portal 769-237	Stáhnout
---------------------------	----------

WSCAD Universe 769-237	Stáhnout
------------------------	----------

Handling Instructions

Assembly

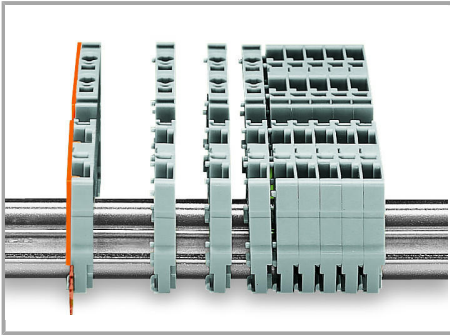

Snap individual carrier terminal blocks onto the carrier rail and slide together.

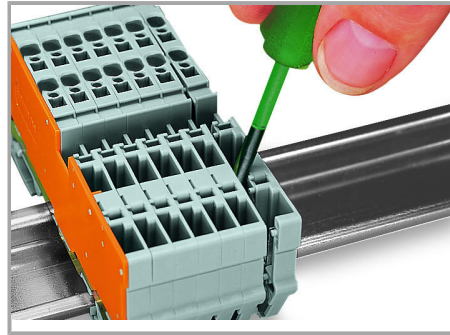

Open the assembly by laterally sliding a block via operating tool and remove terminal block via release lever.

Inserting a conductor

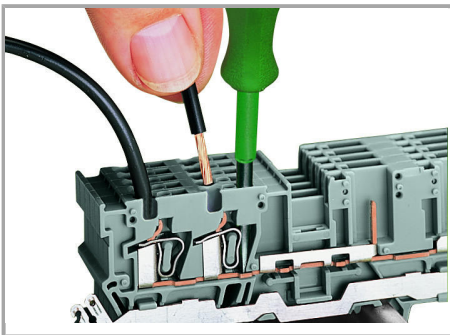

CAGE CLAMP® connection

Carrier terminal block: Insert/remove conductor via operating tool (3.5 x 0.5 mm blade).

Jumpered

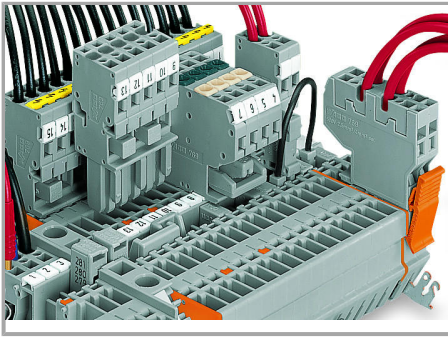

Commoning with adjacent or staggered jumpers –

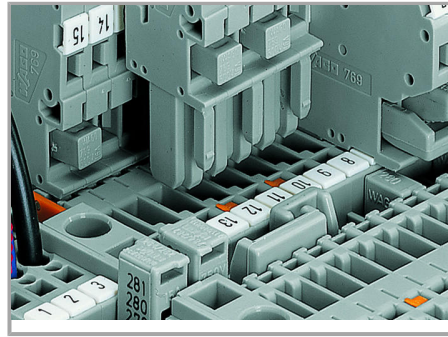

Commoning carrier terminal blocks via staggered jumpers.

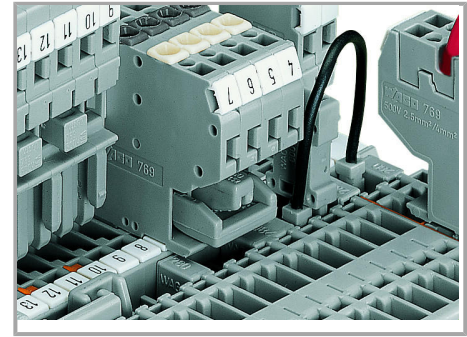

Commoning a 2-conductor female plug via staggered jumper and carrier terminal blocks via adjacent jumpers.

push jumpers down until fully inserted.

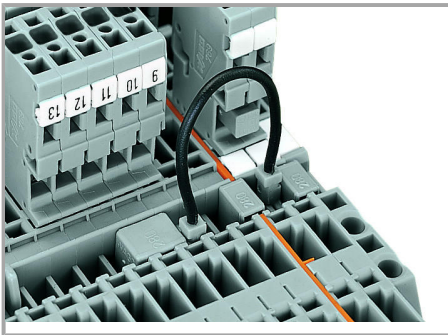

Commoning carrier terminal blocks via push-in type wire jumpers or adjacent jumpers – even over an intermediate plate.

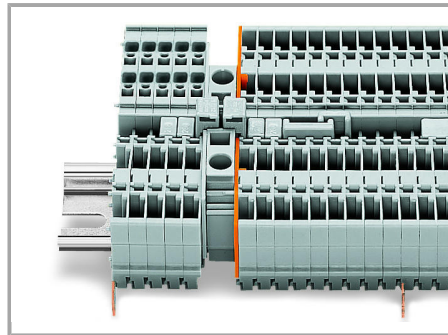

Commoning “supply terminal blocks” (up to 10 mm²/8 AWG) with carrier terminal blocks via step-down jumpers.

Testing

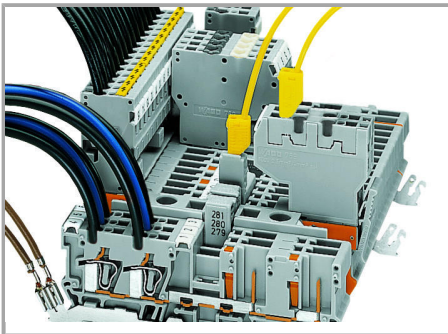

Testing via 2 or 2.3 mm Ø test plugs.

Coding

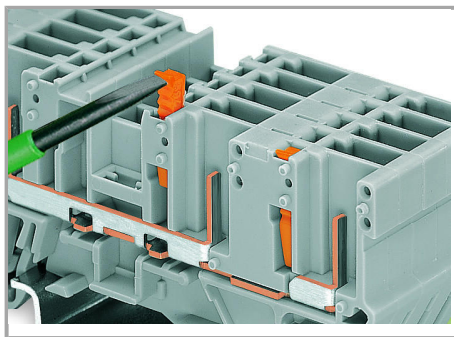

Snap coding pin in proper direction on carrier terminal block.

Shown: Coding pin removal from carrier terminal block.

Locking

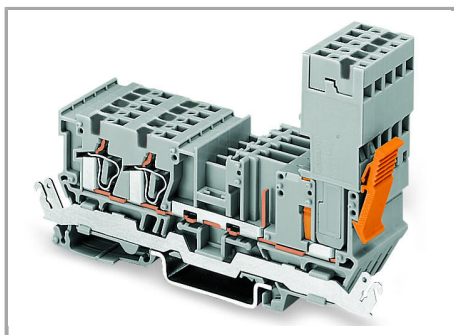

Female plug secured with locking lever on the terminal block side.

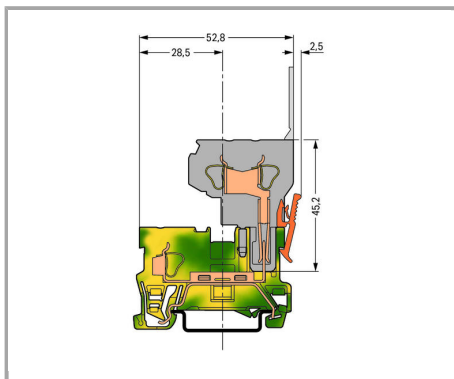

Ground carrier terminal block

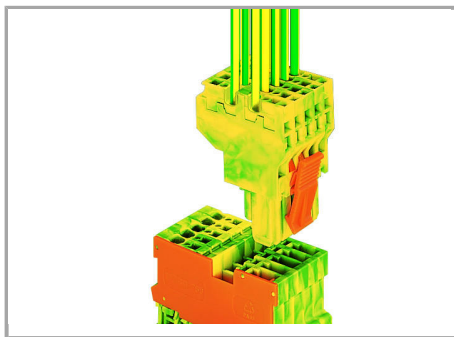

1-conductor/1-pin ground carrier terminal
block

2-conductor female plug, green-yellow

Produktová rodina

X-COM

[Zobrazit všechny produkty z rodiny](#)

Změny vyhrazeny.

WAGO Elektro spol. sr. o.
Rozvodova 1116/36
143 00 Praha 12 - Modřany
Tel.: +420 261 090 143
Email: info.cz@wago.com, wago-cz@wago.com

Máte otázky ohledně našich produktů?
Kdykoli nám zavolejte na číslo +420 261 090 143.