

Data

Údaje o připojení

Celkový počet potenciálů

1



| | |
|-----------------|-----------------|
| Počet úrovní | 1 |
| Způsob zapojení | čelní připojení |

Geometrické údaje

| | |
|-----------------------------------|----------------------|
| Šířka | 5 mm / 0.197 inch |
| Výška od horní hrany lišty DIN 35 | 28,5 mm / 1.122 inch |
| Hloubka | 52,5 mm / 2.067 inch |

Mechanické parametry

| | |
|-------------------|------------------------|
| Provedení | Horizontální provedení |
| Způsob montáže | Lišta DIN 35 |
| Úroveň popisování | Středový popis |



Údaje o materiálu

| | |
|-------------------|---------------------|
| barva | Zeleno-žlutá |
| Izolační materiál | Polyamid 66 (PA 66) |
| Požární zatížení | 0.099 MJ |
| Hmotnost | 6.12 g |



Obchodní údaje

| | |
|--------------------|-------------------|
| Product Group | 18 (X-COM-System) |
| Druh balení | BOX |
| Country of origin | DE |
| GTIN | 4044918827829 |
| Customs Tariff No. | 85369010000 |



Atesty/certifikáty**Specifické atesty jednotlivých států**

| Logo | Schválení | Doplňkový text schválení | Název certifikátu |
|--|---------------------------------------|--------------------------|-------------------|
|  | CCA DEKRA Certification B.V. | EN 60947 | NTR NL- 7626 |
|  | CSA DEKRA Certification B.V. | C22.2 No. 158 | 1101144 |
|  | KEMA/KEUR DEKRA Certification B.V. | EN 60947 | 2190419.01 |

Atesty pro použití v lodním průmyslu



| Logo | Schválení | Doplňkový text schválení | Název certifikátu |
|---|---|--------------------------|--------------------------|
|  | ABS American Bureau of Shipping | EN 60947 | 14- HG1293677- PDA |
|  | DNV GL Det Norske Veritas, Germanischer Lloyd | - | TAE00001V2 |
|  | LR Lloyds Register | EN 60947 | 91/20112 (E9) |















Atesty UL

| Logo | Schválení | Doplňkový text schválení | Název certifikátu |
|--|---|--------------------------|---------------------|
|  | UR Underwriters Laboratories Inc. | UL 1977 | E45171- 20010720 |
|  | UR Underwriters Laboratories Inc. | UL 1059 | 20190731- E45172 |















Kompatibilní produkty















Marking accessories















| | | |
|--|---|--|
|  | Obj. č.: 2009-145 Mini-WSB Inline; Pro Smart Printer; Na cívce; Flexibilní, 5–5,2 mm; Bez potisku; Možnost naklapnutí; Bílá | www.wago.com/2009-145 |
|  | Obj. č.: 2009-145/000-002 Mini-WSB Inline; Pro Smart Printer; Na cívce; Flexibilní, 5–5,2 mm; Bez potisku; Možnost naklapnutí; Žlutá /000-002 | www.wago.com/2009-145 |
| | Obj. č.: 2009-145/000-005 | |















| | | |
|--|---|--|
|  | Mini-WSB Inline; Pro Smart Printer; Na cívce; Flexibilní, 5–5,2 mm; Bez potisku; Možnost naklapnutí; Červená | www.wago.com/2009-145/000-005 |
|  | Obj. č.: 2009-145/000-006 Mini-WSB Inline; Pro Smart Printer; Na cívce; Flexibilní, 5–5,2 mm; Bez potisku; Možnost naklapnutí; Modrá | www.wago.com/2009-145/000-006 |
|  | Obj. č.: 2009-145/000-007 Mini-WSB Inline; Pro Smart Printer; Na cívce; Flexibilní, 5–5,2 mm; Bez potisku; Možnost naklapnutí; Šedá | www.wago.com/2009-145/000-007 |
|  | Obj. č.: 2009-145/000-012 Mini-WSB Inline; Pro Smart Printer; Na cívce; Flexibilní, 5–5,2 mm; Bez potisku; Možnost naklapnutí; Oranžová | www.wago.com/2009-145/000-012 |
|  | Obj. č.: 2009-145/000-023 Mini-WSB Inline; Pro Smart Printer; Na cívce; Flexibilní, 5–5,2 mm; Bez potisku; Možnost naklapnutí; Zelená | www.wago.com/2009-145/000-023 |
|  | Obj. č.: 2009-145/000-024 Mini-WSB Inline; Pro Smart Printer; Na cívce; Flexibilní, 5–5,2 mm; Bez potisku; Možnost naklapnutí; Fialová | www.wago.com/2009-145/000-024 |
|  | Obj. č.: 248-501 Systém rychlého popisování Mini-WSB; Bez potisku; Šířka štítků 5 mm; 10 řad po 10 štítcích na každé kartě | www.wago.com/248-501 |
|  | Obj. č.: 248-501/000-002 Popisovací karta Mini-WSB; Jako karta; Neflexibilní; Bez potisku; Možnost naklapnutí; Žlutá | www.wago.com/248-501/000-002 |
|  | Obj. č.: 248-501/000-005 Popisovací karta Mini-WSB; Jako karta; Neflexibilní; Bez potisku; Možnost naklapnutí; Červená | www.wago.com/248-501/000-005 |
|  | Obj. č.: 248-501/000-006 Popisovací karta Mini-WSB; Jako karta; Neflexibilní; Bez potisku; Možnost naklapnutí; Modrá | www.wago.com/248-501/000-006 |
|  | Obj. č.: 248-501/000-007 Popisovací karta Mini-WSB; Jako karta; Neflexibilní; Bez potisku; Možnost naklapnutí; Šedá | www.wago.com/248-501/000-007 |
|  | Obj. č.: 248-501/000-012 Popisovací karta Mini-WSB; Jako karta; Neflexibilní; Bez potisku; Možnost naklapnutí; Oranžová | www.wago.com/248-501/000-012 |
|  | Obj. č.: 248-501/000-017 Popisovací karta Mini-WSB; Jako karta; Neflexibilní; Bez potisku; Možnost naklapnutí; Světle zelená | www.wago.com/248-501/000-017 |
|  | Obj. č.: 248-501/000-023 Popisovací karta Mini-WSB; Jako karta; Neflexibilní; Bez potisku; Možnost naklapnutí; Zelená | www.wago.com/248-501/000-023 |
|  | Obj. č.: 248-501/000-024 Popisovací karta Mini-WSB; Jako karta; Neflexibilní; Bez potisku; Možnost naklapnutí; Fialová | www.wago.com/248-501/000-024 |















Female plug

| | | |
|---|--|--|
|  | Obj. č.: 769-101 1vodičová pružinová svorkovnice; 4 mm ² ; 1pól.; 4,00 mm ² ; Šedá | www.wago.com/769-101 |
|  | Obj. č.: 769-101/000-006 1vodičová pružinová svorkovnice; 4 mm ² ; 1pól.; 4,00 mm ² ; Modrá | www.wago.com/769-101/000-006 |
|  | Obj. č.: 769-101/000-016 1vodičová pružinová svorkovnice; 4 mm ² ; 1pól.; 4,00 mm ² ; Zeleno-žlutá | www.wago.com/769-101/000-016 |
|  | Obj. č.: 769-101/022-000 1vodičová pružinová svorkovnice; Úhlové provedení; 4 mm ² ; 1pól.; 4,00 mm ² ; Šedá | www.wago.com/769-101/022-000 |
|  | Obj. č.: 769-101/022-016 1vodičová pružinová svorkovnice; Úhlové provedení; 4 mm ² ; 1pól.; 4,00 mm ² ; Zeleno-žlutá | www.wago.com/769-101/022-016 |
|  | Obj. č.: 769-102 1vodičová pružinová svorkovnice; 4 mm ² ; 2pól.; 4,00 mm ² ; Šedá | www.wago.com/769-102 |
|  | Obj. č.: 769-102/000-006 1vodičová pružinová svorkovnice; 4 mm ² ; 2pól.; 4,00 mm ² ; Modrá | www.wago.com/769-102/000-006 |
|  | Obj. č.: 769-102/000-036 1vodičová pružinová svorkovnice; 4 mm ² ; 2pól.; 4,00 mm ² ; Šedá / zelená – žlutá | www.wago.com/769-102/000-036 |
|  | Obj. č.: 769-102/000-037 1vodičová pružinová svorkovnice; 4 mm ² ; 2pól.; 4,00 mm ² ; Zelená – žlutá / šedá | www.wago.com/769-102/000-037 |
|  | Obj. č.: 769-102/022-000 1vodičová pružinová svorkovnice; Úhlové provedení; 4 mm ² ; 2pól.; 4,00 mm ² ; Šedá | www.wago.com/769-102/022-000 |
|  | Obj. č.: 769-103 1vodičová pružinová svorkovnice; 4 mm ² ; 3pól.; 4,00 mm ² ; Šedá | www.wago.com/769-103 |
|  | Obj. č.: 769-103/000-006 1vodičová pružinová svorkovnice; 4 mm ² ; 3pól.; 4,00 mm ² ; Modrá | www.wago.com/769-103/000-006 |
|  | Obj. č.: 769-103/000-036 1vodičová pružinová svorkovnice; 4 mm ² ; 3pól.; 4,00 mm ² ; Šedá / zelená – žlutá | www.wago.com/769-103/000-036 |
|  | Obj. č.: 769-103/000-037 1vodičová pružinová svorkovnice; 4 mm ² ; 3pól.; 4,00 mm ² ; Zelená – žlutá / šedá | www.wago.com/769-103/000-037 |
|  | Obj. č.: 769-103/000-038 1vodičová pružinová svorkovnice; 4 mm ² ; 3pól.; 4,00 mm ² ; Šedá / modrá / zelená – žlutá | www.wago.com/769-103/000-038 |

| | | |
|--|--|--|
|  | Obj. č.: 769-103/000-039 1 vodičová pružinová svorkovnice; 4 mm ² ; 3pól.; 4,00 mm ² ; Zelená – žlutá, modrá, šedá | www.wago.com/769-103/000-039 |
|  | Obj. č.: 769-103/022-000 1 vodičová pružinová svorkovnice; Úhlové provedení; 4 mm ² ; 3pól.; 4,00 mm ² ; Šedá | www.wago.com/769-103/022-000 |
|  | Obj. č.: 769-104 1 vodičová pružinová svorkovnice; 4 mm ² ; 4pól.; 4,00 mm ² ; Šedá | www.wago.com/769-104 |
|  | Obj. č.: 769-104/000-006 1 vodičová pružinová svorkovnice; 4 mm ² ; 4pól.; 4,00 mm ² ; Modrá | www.wago.com/769-104/000-006 |
|  | Obj. č.: 769-104/000-036 1 vodičová pružinová svorkovnice; 4 mm ² ; 4pól.; 4,00 mm ² ; Šedá / zelená – žlutá | www.wago.com/769-104/000-036 |
|  | Obj. č.: 769-104/000-037 1 vodičová pružinová svorkovnice; 4 mm ² ; 4pól.; 4,00 mm ² ; Zelená – žlutá / šedá | www.wago.com/769-104/000-037 |
|  | Obj. č.: 769-104/000-038 1 vodičová pružinová svorkovnice; 4 mm ² ; 4pól.; 4,00 mm ² ; Šedá / modrá / zelená – žlutá | www.wago.com/769-104/000-038 |
|  | Obj. č.: 769-104/000-039 1 vodičová pružinová svorkovnice; 4 mm ² ; 4pól.; 4,00 mm ² ; Zelená – žlutá, modrá, šedá | www.wago.com/769-104/000-039 |
|  | Obj. č.: 769-104/022-000 1 vodičová pružinová svorkovnice; Úhlové provedení; 4 mm ² ; 4pól.; 4,00 mm ² ; Šedá | www.wago.com/769-104/022-000 |
|  | Obj. č.: 769-105 1 vodičová pružinová svorkovnice; 4 mm ² ; 5pól.; 4,00 mm ² ; Šedá | www.wago.com/769-105 |
|  | Obj. č.: 769-105/000-006 1 vodičová pružinová svorkovnice; 4 mm ² ; 5pól.; 4,00 mm ² ; Modrá | www.wago.com/769-105/000-006 |
|  | Obj. č.: 769-105/000-036 1 vodičová pružinová svorkovnice; 4 mm ² ; 5pól.; 4,00 mm ² ; Šedá / zelená – žlutá | www.wago.com/769-105/000-036 |
|  | Obj. č.: 769-105/000-037 1 vodičová pružinová svorkovnice; 4 mm ² ; 5pól.; 4,00 mm ² ; Zelená – žlutá / šedá | www.wago.com/769-105/000-037 |
|  | Obj. č.: 769-105/000-038 1 vodičová pružinová svorkovnice; 4 mm ² ; 5pól.; 4,00 mm ² ; Šedá / modrá / zelená – žlutá | www.wago.com/769-105/000-038 |
|  | Obj. č.: 769-105/000-039 1 vodičová pružinová svorkovnice; 4 mm ² ; 5pól.; 4,00 mm ² ; Zelená – žlutá, modrá, šedá | www.wago.com/769-105/000-039 |

| | | |
|--|--|--|
|  | Obj. č.: 769-105/022-000 1 vodičová pružinová svorkovnice; Úhlové provedení; 4 mm ² ; 5pól.; 4,00 mm ² ; Šedá | www.wago.com/769-105/022-000 |
|  | Obj. č.: 769-106 1 vodičová pružinová svorkovnice; 4 mm ² ; 6pól.; 4,00 mm ² ; Šedá | www.wago.com/769-106 |
|  | Obj. č.: 769-106/000-006 1 vodičová pružinová svorkovnice; 4 mm ² ; 6pól.; 4,00 mm ² ; Modrá | www.wago.com/769-106/000-006 |
|  | Obj. č.: 769-106/000-036 1 vodičová pružinová svorkovnice; 4 mm ² ; 6pól.; 4,00 mm ² ; Šedá / zelená – žlutá | www.wago.com/769-106/000-036 |
|  | Obj. č.: 769-106/000-037 1 vodičová pružinová svorkovnice; 4 mm ² ; 6pól.; 4,00 mm ² ; Zelená – žlutá / šedá | www.wago.com/769-106/000-037 |
|  | Obj. č.: 769-106/000-038 1 vodičová pružinová svorkovnice; 4 mm ² ; 6pól.; 4,00 mm ² ; Šedá / modrá / zelená – žlutá | www.wago.com/769-106/000-038 |
|  | Obj. č.: 769-106/000-039 1 vodičová pružinová svorkovnice; 4 mm ² ; 6pól.; 4,00 mm ² ; Zelená – žlutá, modrá, šedá | www.wago.com/769-106/000-039 |
|  | Obj. č.: 769-106/022-000 1 vodičová pružinová svorkovnice; Úhlové provedení; 4 mm ² ; 6pól.; 4,00 mm ² ; Šedá | www.wago.com/769-106/022-000 |
|  | Obj. č.: 769-107 1 vodičová pružinová svorkovnice; 4 mm ² ; 7pól.; 4,00 mm ² ; Šedá | www.wago.com/769-107 |
|  | Obj. č.: 769-107/000-006 1 vodičová pružinová svorkovnice; 4 mm ² ; 7pól.; 4,00 mm ² ; Modrá | www.wago.com/769-107/000-006 |
|  | Obj. č.: 769-107/000-036 1 vodičová pružinová svorkovnice; 4 mm ² ; 7pól.; 4,00 mm ² ; Šedá / zelená – žlutá | www.wago.com/769-107/000-036 |
|  | Obj. č.: 769-107/000-037 1 vodičová pružinová svorkovnice; 4 mm ² ; 7pól.; 4,00 mm ² ; Zelená – žlutá / šedá | www.wago.com/769-107/000-037 |
|  | Obj. č.: 769-107/000-038 1 vodičová pružinová svorkovnice; 4 mm ² ; 7pól.; 4,00 mm ² ; Šedá / modrá / zelená – žlutá | www.wago.com/769-107/000-038 |
|  | Obj. č.: 769-107/000-039 1 vodičová pružinová svorkovnice; 4 mm ² ; 7pól.; 4,00 mm ² ; Zelená – žlutá, modrá, šedá | www.wago.com/769-107/000-039 |
|  | Obj. č.: 769-107/022-000 1 vodičová pružinová svorkovnice; Úhlové provedení; 4 mm ² ; 7pól.; 4,00 mm ² ; Šedá | www.wago.com/769-107/022-000 |

| | | |
|--|--|--|
|  | Obj. č.: 769-108 1 vodičová pružinová svorkovnice; 4 mm ² ; 8pól.; 4,00 mm ² ; Šedá | www.wago.com/769-108 |
|  | Obj. č.: 769-108/000-006 1 vodičová pružinová svorkovnice; 4 mm ² ; 8pól.; 4,00 mm ² ; Modrá | www.wago.com/769-108/000-006 |
|  | Obj. č.: 769-108/000-036 1 vodičová pružinová svorkovnice; 4 mm ² ; 8pól.; 4,00 mm ² ; Šedá / zelená – žlutá | www.wago.com/769-108/000-036 |
|  | Obj. č.: 769-108/000-037 1 vodičová pružinová svorkovnice; 4 mm ² ; 8pól.; 4,00 mm ² ; Zelená – žlutá / šedá | www.wago.com/769-108/000-037 |
|  | Obj. č.: 769-108/000-038 1 vodičová pružinová svorkovnice; 4 mm ² ; 8pól.; 4,00 mm ² ; Šedá / modrá / zelená – žlutá | www.wago.com/769-108/000-038 |
|  | Obj. č.: 769-108/000-039 1 vodičová pružinová svorkovnice; 4 mm ² ; 8pól.; 4,00 mm ² ; Zelená – žlutá, modrá, šedá | www.wago.com/769-108/000-039 |
|  | Obj. č.: 769-108/022-000 1 vodičová pružinová svorkovnice; Úhlové provedení; 4 mm ² ; 8pól.; 4,00 mm ² ; Šedá | www.wago.com/769-108/022-000 |
|  | Obj. č.: 769-109 1 vodičová pružinová svorkovnice; 4 mm ² ; 9pól.; 4,00 mm ² ; Šedá | www.wago.com/769-109 |
|  | Obj. č.: 769-109/000-006 1 vodičová pružinová svorkovnice; 4 mm ² ; 9pól.; 4,00 mm ² ; Modrá | www.wago.com/769-109/000-006 |
|  | Obj. č.: 769-109/000-036 1 vodičová pružinová svorkovnice; 4 mm ² ; 9pól.; 4,00 mm ² ; Šedá / zelená – žlutá | www.wago.com/769-109/000-036 |
|  | Obj. č.: 769-109/000-037 1 vodičová pružinová svorkovnice; 4 mm ² ; 9pól.; 4,00 mm ² ; Zelená – žlutá / šedá | www.wago.com/769-109/000-037 |
|  | Obj. č.: 769-109/000-038 1 vodičová pružinová svorkovnice; 4 mm ² ; 9pól.; 4,00 mm ² ; Šedá / modrá / zelená – žlutá | www.wago.com/769-109/000-038 |
|  | Obj. č.: 769-109/000-039 1 vodičová pružinová svorkovnice; 4 mm ² ; 9pól.; 4,00 mm ² ; Zelená – žlutá, modrá, šedá | www.wago.com/769-109/000-039 |
|  | Obj. č.: 769-109/022-000 1 vodičová pružinová svorkovnice; Úhlové provedení; 4 mm ² ; 9pól.; 4,00 mm ² ; Šedá | www.wago.com/769-109/022-000 |
|  | Obj. č.: 769-110 1 vodičová pružinová svorkovnice; 4 mm ² ; 10pól.; 4,00 mm ² ; Šedá | www.wago.com/769-110 |

| | | |
|--|---|--|
|  | Obj. č.: 769-110/000-006 1 vodičová pružinová svorkovnice; 4 mm ² ; 10pól.; 4,00 mm ² ; Modrá | www.wago.com/769-110/000-006 |
|  | Obj. č.: 769-110/000-036 1 vodičová pružinová svorkovnice; 4 mm ² ; 10pól.; 4,00 mm ² ; Šedá / zelená – žlutá | www.wago.com/769-110/000-036 |
|  | Obj. č.: 769-110/000-037 1 vodičová pružinová svorkovnice; 4 mm ² ; 10pól.; 4,00 mm ² ; Zelená – žlutá / šedá | www.wago.com/769-110/000-037 |
|  | Obj. č.: 769-110/000-038 1 vodičová pružinová svorkovnice; 4 mm ² ; 10pól.; 4,00 mm ² ; Šedá / modrá / zelená – žlutá | www.wago.com/769-110/000-038 |
|  | Obj. č.: 769-110/000-039 1 vodičová pružinová svorkovnice; 4 mm ² ; 10pól.; 4,00 mm ² ; Zelená – žlutá, modrá, šedá | www.wago.com/769-110/000-039 |
|  | Obj. č.: 769-110/022-000 1 vodičová pružinová svorkovnice; Úhlové provedení; 4 mm ² ; 10pól.; 4,00 mm ² ; Šedá | www.wago.com/769-110/022-000 |
|  | Obj. č.: 769-111 1 vodičová pružinová svorkovnice; 4 mm ² ; 11pól.; 4,00 mm ² ; Šedá | www.wago.com/769-111 |
|  | Obj. č.: 769-111/000-006 1 vodičová pružinová svorkovnice; 4 mm ² ; 11pól.; 4,00 mm ² ; Modrá | www.wago.com/769-111/000-006 |
|  | Obj. č.: 769-111/000-036 1 vodičová pružinová svorkovnice; 4 mm ² ; 11pól.; 4,00 mm ² ; Šedá / zelená – žlutá | www.wago.com/769-111/000-036 |
|  | Obj. č.: 769-111/000-037 1 vodičová pružinová svorkovnice; 4 mm ² ; 11pól.; 4,00 mm ² ; Zelená – žlutá / šedá | www.wago.com/769-111/000-037 |
|  | Obj. č.: 769-111/000-038 1 vodičová pružinová svorkovnice; 4 mm ² ; 11pól.; 4,00 mm ² ; Šedá / modrá / zelená – žlutá | www.wago.com/769-111/000-038 |
|  | Obj. č.: 769-111/000-039 1 vodičová pružinová svorkovnice; 4 mm ² ; 11pól.; 4,00 mm ² ; Zelená – žlutá, modrá, šedá | www.wago.com/769-111/000-039 |
|  | Obj. č.: 769-111/022-000 1 vodičová pružinová svorkovnice; Úhlové provedení; 4 mm ² ; 11pól.; 4,00 mm ² ; Šedá | www.wago.com/769-111/022-000 |
|  | Obj. č.: 769-112 1 vodičová pružinová svorkovnice; 4 mm ² ; 12pól.; 4,00 mm ² ; Šedá | www.wago.com/769-112 |
|  | Obj. č.: 769-112/000-006 1 vodičová pružinová svorkovnice; 4 mm ² ; 12pól.; 4,00 mm ² ; Modrá | www.wago.com/769-112/000-006 |



Obj. č.: 769-112/000-036
1 vodičová pružinová svorkovnice; 4 mm²; 12pól.; 4,00 mm²; Šedá / zelená – žlutá

www.wago.com/769-112/000-036



Obj. č.: 769-112/000-037
1 vodičová pružinová svorkovnice; 4 mm²; 12pól.; 4,00 mm²; Zelená – žlutá / šedá

www.wago.com/769-112/000-037



Obj. č.: 769-112/000-038
1 vodičová pružinová svorkovnice; 4 mm²; 12pól.; 4,00 mm²; Šedá / modrá / zelená – žlutá

www.wago.com/769-112/000-038



Obj. č.: 769-112/000-039
1 vodičová pružinová svorkovnice; 4 mm²; 12pól.; 4,00 mm²; Zelená – žlutá, modrá, šedá

www.wago.com/769-112/000-039



Obj. č.: 769-112/022-000
1 vodičová pružinová svorkovnice; Úhlové provedení; 4 mm²; 12pól.; 4,00 mm²; Šedá

www.wago.com/769-112/022-000



Obj. č.: 769-113
1 vodičová pružinová svorkovnice; 4 mm²; 13pól.; 4,00 mm²; Šedá

www.wago.com/769-113



Obj. č.: 769-113/000-036
1 vodičová pružinová svorkovnice; 4 mm²; 13pól.; 4,00 mm²; Šedá / zelená – žlutá

www.wago.com/769-113/000-036



Obj. č.: 769-113/000-037
1 vodičová pružinová svorkovnice; 4 mm²; 13pól.; 4,00 mm²; Zelená – žlutá / šedá

www.wago.com/769-113/000-037



Obj. č.: 769-113/000-038
1 vodičová pružinová svorkovnice; 4 mm²; 13pól.; 4,00 mm²; Šedá / modrá / zelená – žlutá

www.wago.com/769-113/000-038



Obj. č.: 769-113/000-039
1 vodičová pružinová svorkovnice; 4 mm²; 13pól.; 4,00 mm²; Zelená – žlutá, modrá, šedá

www.wago.com/769-113/000-039



Obj. č.: 769-113/022-000
1 vodičová pružinová svorkovnice; Úhlové provedení; 4 mm²; 13pól.; 4,00 mm²; Šedá

www.wago.com/769-113/022-000



Obj. č.: 769-114
1 vodičová pružinová svorkovnice; 4 mm²; 14pól.; 4,00 mm²; Šedá

www.wago.com/769-114



Obj. č.: 769-114/000-006
1 vodičová pružinová svorkovnice; 4 mm²; 14pól.; 4,00 mm²; Modrá

www.wago.com/769-114/000-006



















Obj. č.: 769-114/000-036
1 vodičová pružinová svorkovnice; 4 mm²; 14pól.; 4,00 mm²; Šedá / zelená – žlutá

www.wago.com/769-114/000-036











Obj. č.: 769-114/000-037
1 vodičová pružinová svorkovnice; 4 mm²; 14pól.; 4,00 mm²; Zelená – žlutá / šedá

www.wago.com/769-114/000-037

| | | |
|--|--|--|
|  | Obj. č.: 769-114/000-038 1vodičová pružinová svorkovnice; 4 mm ² ; 14pól.; 4,00 mm ² ; Šedá / modrá / zelená – žlutá | www.wago.com/769-114/000-038 |
|  | Obj. č.: 769-114/000-039 1vodičová pružinová svorkovnice; 4 mm ² ; 14pól.; 4,00 mm ² ; Zelená – žlutá, modrá, šedá | www.wago.com/769-114/000-039 |
|  | Obj. č.: 769-114/022-000 1vodičová pružinová svorkovnice; Úhlové provedení; 4 mm ² ; 14pól.; 4,00 mm ² ; Šedá | www.wago.com/769-114/022-000 |
|  | Obj. č.: 769-115 1vodičová pružinová svorkovnice; 4 mm ² ; 15pól.; 4,00 mm ² ; Šedá | www.wago.com/769-115 |
|  | Obj. č.: 769-115/000-036 1vodičová pružinová svorkovnice; 4 mm ² ; 15pól.; 4,00 mm ² ; Šedá / zelená – žlutá | www.wago.com/769-115/000-036 |
|  | Obj. č.: 769-115/000-037 1vodičová pružinová svorkovnice; 4 mm ² ; 15pól.; 4,00 mm ² ; Zelená – žlutá / šedá | www.wago.com/769-115/000-037 |
|  | Obj. č.: 769-115/000-038 1vodičová pružinová svorkovnice; 4 mm ² ; 15pól.; 4,00 mm ² ; Šedá / modrá / zelená – žlutá | www.wago.com/769-115/000-038 |
|  | Obj. č.: 769-115/000-039 1vodičová pružinová svorkovnice; 4 mm ² ; 15pól.; 4,00 mm ² ; Zelená – žlutá, modrá, šedá | www.wago.com/769-115/000-039 |
|  | Obj. č.: 769-115/022-000 1vodičová pružinová svorkovnice; Úhlové provedení; 4 mm ² ; 15pól.; 4,00 mm ² ; Šedá | www.wago.com/769-115/022-000 |
|  | Obj. č.: 769-121 2vodičová pružinová svorkovnice; 4 mm ² ; 1pól.; 4,00 mm ² ; Šedá | www.wago.com/769-121 |
|  | Obj. č.: 769-121/000-016 2vodičová pružinová svorkovnice; 4 mm ² ; 1pól.; 4,00 mm ² ; Zeleno-žlutá | www.wago.com/769-121/000-016 |
|  | Obj. č.: 769-122 2vodičová pružinová svorkovnice; 4 mm ² ; 2pól.; 4,00 mm ² ; Šedá | www.wago.com/769-122 |
|  | Obj. č.: 769-123 2vodičová pružinová svorkovnice; 4 mm ² ; 3pól.; 4,00 mm ² ; Šedá | www.wago.com/769-123 |
|  | Obj. č.: 769-124 2vodičová pružinová svorkovnice; 4 mm ² ; 4pól.; 4,00 mm ² ; Šedá | www.wago.com/769-124 |
|  | Obj. č.: 769-125 2vodičová pružinová svorkovnice; 4 mm ² ; 5pól.; 4,00 mm ² ; Šedá | www.wago.com/769-125 |
|  | Obj. č.: 769-126 2vodičová pružinová svorkovnice; 4 mm ² ; 6pól.; 4,00 mm ² ; Šedá | www.wago.com/769-126 |
|  | Obj. č.: 769-127 2vodičová pružinová svorkovnice; 4 mm ² ; 7pól.; 4,00 mm ² ; Šedá | www.wago.com/769-127 |



| | | |
|--|---|--|
|  | Obj. č.: 769-128 2vodičová pružinová svorkovnice; 4 mm ² ; 8pól.; 4,00 mm ² ; Šedá | www.wago.com/769-128 |
|  | Obj. č.: 769-129 2vodičová pružinová svorkovnice; 4 mm ² ; 9pól.; 4,00 mm ² ; Šedá | www.wago.com/769-129 |
|  | Obj. č.: 769-130 2vodičová pružinová svorkovnice; 4 mm ² ; 10pól.; 4,00 mm ² ; Šedá | www.wago.com/769-130 |
|  | Obj. č.: 769-131 2vodičová pružinová svorkovnice; 4 mm ² ; 11pól.; 4,00 mm ² ; Šedá | www.wago.com/769-131 |
|  | Obj. č.: 769-132 2vodičová pružinová svorkovnice; 4 mm ² ; 12pól.; 4,00 mm ² ; Šedá | www.wago.com/769-132 |
|  | Obj. č.: 769-133 2vodičová pružinová svorkovnice; 4 mm ² ; 13pól.; 4,00 mm ² ; Šedá | www.wago.com/769-133 |
|  | Obj. č.: 769-134 2vodičová pružinová svorkovnice; 4 mm ² ; 14pól.; 4,00 mm ² ; Šedá | www.wago.com/769-134 |
|  | Obj. č.: 769-135 2vodičová pružinová svorkovnice; 4 mm ² ; 15pól.; 4,00 mm ² ; Šedá | www.wago.com/769-135 |

Coding



| | |
|---|--|
| Obj. č.: 769-435 Kódovací kolík; Ke kódování pružinových svorkovnic; Pro základní svorky / konektory s pájecími piny; Oranžová | www.wago.com/769-435 |
|---|--|

tools



| | |
|---|--|
| Obj. č.: 210-720 Ovládací nástroj; Břit: 3,5 × 0,5 mm; S částečně izolovanou rukojetí | www.wago.com/210-720 |
|---|--|

Jumper



| | |
|---|--|
| Obj. č.: 249-123 Vodičový můstek; Izolováno; L = 180 mm; Průřez vedení 0,75 mm ² | www.wago.com/249-123 |
|---|--|



| | |
|--|--|
| Obj. č.: 249-125 Vodičový můstek; Izolováno; L = 60 mm; Průřez vedení 0,75 mm ² | www.wago.com/249-125 |
|--|--|



| | |
|---|--|
| Obj. č.: 249-126 Vodičový můstek; Izolováno; L = 110 mm; Průřez vedení 0,75 mm ² | www.wago.com/249-126 |
|---|--|

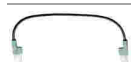

| | |
|---|--|
| Obj. č.: 249-127 Vodičový můstek; Izolováno; L = 250 mm; Průřez vedení 0,75 mm ² | www.wago.com/249-127 |
|---|--|

| | |
|---|--|
| Obj. č.: 280-402 Příčný můstek; Izolováno; IN = IN svorky; Šedá | www.wago.com/280-402 |
|---|--|









| | |
|---|--|
| Obj. č.: 280-409 Příčný můstek ob svorku; Izolováno; IN = IN svorky; Šedá | www.wago.com/280-409 |
|---|--|



| | |
|--|--|
| Obj. č.: 280-422 Příčný můstek; Izolováno; IN = IN svorky; Žlutozelená | www.wago.com/280-422 |
|--|--|

Obj. č.: 780-452

















| | | |
|---|--|--|
|  | Stupňovitý můstek; Izolováno; Z 1 na 2; Rozteč 5 mm; Vhodný pro 2vodičové pružinové svorkovnice; Šedá | www.wago.com/780-452 |
|  | Obj. č.: 780-453 Stupňovitý můstek; Izolováno; z 1 na 3; Rozteč 5 mm; Vhodný pro 2vodičové pružinové svorkovnice; Šedá | www.wago.com/780-453 |
|  | Obj. č.: 780-454 Stupňovitý můstek; Izolováno; Z 1 na 4; Rozteč 5 mm; Vhodný pro 2vodičové pružinové svorkovnice; Šedá | www.wago.com/780-454 |
|  | Obj. č.: 780-455 Stupňovitý můstek; Izolováno; Z 1 na 5; Rozteč 5 mm; Vhodný pro 2vodičové pružinové svorkovnice; Šedá | www.wago.com/780-455 |
|  | Obj. č.: 780-456 Stupňovitý můstek; Izolováno; Z 1 na 6; Rozteč 5 mm; Vhodný pro 2vodičové pružinové svorkovnice; Šedá | www.wago.com/780-456 |
|  | Obj. č.: 780-457 Stupňovitý můstek; Izolováno; Z 1 na 7; Rozteč 5 mm; Vhodný pro 2vodičové pružinové svorkovnice; Šedá | www.wago.com/780-457 |
|  | Obj. č.: 780-458 Stupňovitý můstek; Izolováno; Z 1 na 8; Rozteč 5 mm; Vhodný pro 2vodičové pružinové svorkovnice; Šedá | www.wago.com/780-458 |













assembling

| | | |
|--|---|--|
|  | Obj. č.: 209-106 Držák; K izolované montáži nosných lišt DIN 35; Šedá | www.wago.com/209-106 |
|--|---|--|

General accessories

| | | |
|---|--|--|
|  | Obj. č.: 280-404 Zkušební adaptér; Šířka 5 mm; Pro zkušební hrot 210-137 (Ø 2,3 mm); Vhodná pro svorky 1,5–4 mm ² ; Šedá | www.wago.com/280-404 |
|  | Obj. č.: 280-418 Modul pro zkušební zástrčku; Možnost řadového připojení; Vhodný ke všem řadovým svorkám WAGO řad 280 a 780 s drážkou pro můstek v napájecí liště; Šedá | www.wago.com/280-418 |
|  | Obj. č.: 280-419 Slepý modul; Možnost řadového připojení; K přeskočení svorek; Šedá | www.wago.com/280-419 |
|  | Obj. č.: 769-438 Kryt kolíků; S držákem značení pro Mini-WSB; Šedá | www.wago.com/769-438 |
|  | Obj. č.: 769-439 Kryt kolíků; S držákem značení pro Mini-WSB; Oranžová | www.wago.com/769-439 |
|  | Obj. č.: 769-501 1vodičový počáteční modul s pružinovou svorkovnicí; S integrovanou koncovou bočnicí; 4 mm ² ; 1pól.; 4,00 mm ² ; Šedá | www.wago.com/769-501 |
|  | Obj. č.: 769-501/000-006 1vodičový počáteční modul s pružinovou svorkovnicí; 4 mm ² ; 1pól.; 4,00 mm ² ; Modrá | www.wago.com/769-501/000-006 |
|  | Obj. č.: 769-501/000-016 1vodičový počáteční modul s pružinovou svorkovnicí; S integrovanou koncovou bočnicí; 4 mm ² ; 1pól.; 4,00 mm ² ; Zeleno-žlutá | www.wago.com/769-501/000-016 |
|  | Obj. č.: 769-502 1vodičový středový modul s pružinovou svorkovnicí; 4 mm ² ; 1pól.; 4,00 mm ² ; Šedá | www.wago.com/769-502 |

| | | |
|--|--|--|
|  | Obj. č.: 769-502/000-006 1 vodičový středový modul s pružinovou svorkovnicí; 4 mm ² ; 1pól.; 4,00 mm ² ; Modrá | www.wago.com/769-502/000-006 |
|  | Obj. č.: 769-502/000-016 1 vodičový středový modul s pružinovou svorkovnicí; 4 mm ² ; 1pól.; 4,00 mm ² ; Zeleno-žlutá | www.wago.com/769-502/000-016 |
|  | Obj. č.: 769-503 1 vodičový koncový modul s pružinovou svorkovnicí; 4 mm ² ; 1pól.; 4,00 mm ² ; Šedá | www.wago.com/769-503 |
|  | Obj. č.: 769-503/000-006 1 vodičový koncový modul s pružinovou svorkovnicí; 4 mm ² ; 1pól.; 4,00 mm ² ; Modrá | www.wago.com/769-503/000-006 |
|  | Obj. č.: 769-503/000-016 1 vodičový koncový modul s pružinovou svorkovnicí; 4 mm ² ; 1pól.; 4,00 mm ² ; Zeleno-žlutá | www.wago.com/769-503/000-016 |
|  | Obj. č.: 769-504 2 vodičový počáteční modul s pružinovou svorkovnicí; S integrovanou koncovou bočnicí; 4 mm ² ; 1pól.; 4,00 mm ² ; Šedá | www.wago.com/769-504 |
|  | Obj. č.: 769-504/000-006 2 vodičový počáteční modul s pružinovou svorkovnicí; S integrovanou koncovou bočnicí; 4 mm ² ; 1pól.; 4,00 mm ² ; Modrá | www.wago.com/769-504/000-006 |
|  | Obj. č.: 769-504/000-016 2 vodičový počáteční modul s pružinovou svorkovnicí; 4 mm ² ; 1pól.; 4,00 mm ² ; Zeleno-žlutá | www.wago.com/769-504/000-016 |
|  | Obj. č.: 769-505 2 vodičový středový modul s pružinovou svorkovnicí; 4 mm ² ; 1pól.; 4,00 mm ² ; Šedá | www.wago.com/769-505 |
|  | Obj. č.: 769-505/000-006 2 vodičový středový modul s pružinovou svorkovnicí; 4 mm ² ; 1pól.; 4,00 mm ² ; Modrá | www.wago.com/769-505/000-006 |
|  | Obj. č.: 769-505/000-016 2 vodičový středový modul s pružinovou svorkovnicí; 4 mm ² ; 1pól.; 4,00 mm ² ; Zeleno-žlutá | www.wago.com/769-505/000-016 |
|  | Obj. č.: 769-506 2 vodičový koncový modul s pružinovou svorkovnicí; 4 mm ² ; 1pól.; 4,00 mm ² ; Šedá | www.wago.com/769-506 |
|  | Obj. č.: 769-506/000-006 2 vodičový koncový modul s pružinovou svorkovnicí; 4 mm ² ; 1pól.; 4,00 mm ² ; Modrá | www.wago.com/769-506/000-006 |
|  | Obj. č.: 769-506/000-016 2 vodičový koncový modul s pružinovou svorkovnicí; 4 mm ² ; 1pól.; 4,00 mm ² ; Zeleno-žlutá | www.wago.com/769-506/000-016 |
|  | Obj. č.: 769-512 1 vodičový počáteční modul s pružinovou svorkovnicí; Úhlové provedení; 4 mm ² ; 1pól.; 4,00 mm ² ; Šedá | www.wago.com/769-512 |
|  | Obj. č.: 769-512/000-006 1 vodičový počáteční modul s pružinovou svorkovnicí; Úhlové provedení; 4 mm ² ; 1pól.; 4,00 mm ² ; Modrá | www.wago.com/769-512/000-006 |

| | | |
|--|--|--|
|  | Obj. č.: 769-512/000-016 1 vodičový počáteční modul s pružinovou svorkovnicí; Úhlové provedení; 4 mm ² ; 1pól.; 4,00 mm ² ; Zeleno-žlutá | www.wago.com/769-512/000-016 |
|  | Obj. č.: 769-513 1 vodičový středový modul s pružinovou svorkovnicí; Úhlové provedení; 4 mm ² ; 1pól.; 4,00 mm ² ; Šedá | www.wago.com/769-513 |
|  | Obj. č.: 769-513/000-006 1 vodičový středový modul s pružinovou svorkovnicí; Úhlové provedení; 4 mm ² ; 1pól.; 4,00 mm ² ; Modrá | www.wago.com/769-513/000-006 |
|  | Obj. č.: 769-513/000-016 1 vodičový středový modul s pružinovou svorkovnicí; Úhlové provedení; 4 mm ² ; 1pól.; 4,00 mm ² ; Zeleno-žlutá | www.wago.com/769-513/000-016 |
|  | Obj. č.: 769-515 1 vodičový koncový modul s pružinovou svorkovnicí; Úhlové provedení; 4 mm ² ; 1pól.; 4,00 mm ² ; Šedá | www.wago.com/769-515 |
|  | Obj. č.: 769-515/000-006 1 vodičový koncový modul s pružinovou svorkovnicí; Úhlové provedení; 4 mm ² ; 1pól.; 4,00 mm ² ; Modrá | www.wago.com/769-515/000-006 |
|  | Obj. č.: 769-515/000-016 1 vodičový koncový modul s pružinovou svorkovnicí; Úhlové provedení; 4 mm ² ; 1pól.; 4,00 mm ² ; Zeleno-žlutá | www.wago.com/769-515/000-016 |
| check | | |
|  | Obj. č.: 210-137 Zkušební hrot; Ø 2,3 mm; S 500mm vedením; Žlutá | www.wago.com/210-137 |
| End plate | | |
|  | Obj. č.: 769-305 Koncová bočnice a separátor; Tloušťka 1,1 mm; Šedá | www.wago.com/769-305 |
|  | Obj. č.: 769-306 Koncová bočnice a separátor; Tloušťka 1,1 mm; Oranžová | www.wago.com/769-306 |
| Carrier rail | | |
|  | Obj. č.: 210-112 Ocelová nosná lišta; 35 × 7,5 mm; Tloušťka 1 mm; Délka 2 m; Děrovaná; Dle normy EN 60715; Šířka otvorů 25 mm; vzdálenost mezi otvory 36 mm | www.wago.com/210-112 |
| | Obj. č.: 210-113 Ocelová nosná lišta; 35 × 7,5 mm; Tloušťka 1 mm; Délka 2 m; Neděrovaná; Dle normy EN 60715 | www.wago.com/210-113 |
| | Obj. č.: 210-114 Ocelová nosná lišta; 35 × 15 mm; Tloušťka 1,5 mm; Délka 2 m; Neděrovaná; Podobné EN 60715 | www.wago.com/210-114 |
|  | Obj. č.: 210-115 Ocelová nosná lišta; 35 × 7,5 mm; Tloušťka 1 mm; Délka 2 m; Děrovaná; Dle normy EN 60715; Šířka otvorů 18 mm; vzdálenost mezi otvory 25 mm | www.wago.com/210-115 |
|  | Obj. č.: 210-118 Ocelová nosná lišta; 35 × 15 mm; Tloušťka 2,3 mm; Délka 2 m; Neděrovaná; Dle normy EN 60715 | www.wago.com/210-118 |
| | Obj. č.: 210-196 Hliníková nosná lišta; 35 × 8,2 mm; Tloušťka 1,6 mm; Délka 2 m; Neděrovaná; Podobné EN 60715; Stříbrná | www.wago.com/210-196 |

| | | |
|--|---|--|
|  | Obj. č.: 210-197 Ocelová nosná lišta; 35 × 15 mm; Tloušťka 1,5 mm; Délka 2 m; Děrovaná; Podobné EN 60715 | www.wago.com/210-197 |
|  | Obj. č.: 210-198 Měděná nosná lišta; 35 × 15 mm; Tloušťka 2,3 mm; Délka 2 m; Neděrovaná; Dle normy EN 60715; Měděná | www.wago.com/210-198 |
|  | Obj. č.: 210-504 Ocelová nosná lišta; 35 × 7,5 mm; Tloušťka 1 mm; Délka 2 m; Děrovaná; Pásově zinkováno; Dle normy EN 60715 | www.wago.com/210-504 |
|  | Obj. č.: 210-505 Ocelová nosná lišta; 35 × 7,5 mm; Tloušťka 1 mm; Délka 2 m; Neděrovaná; Pásově zinkováno; Dle normy EN 60715 | www.wago.com/210-505 |
|  | Obj. č.: 210-506 Ocelová nosná lišta; 35 × 15 mm; Tloušťka 1,5 mm; Délka 2 m; Neděrovaná; Pásově zinkováno; Podobné EN 60715 | www.wago.com/210-506 |
|  | Obj. č.: 210-508 Ocelová nosná lišta; 35 × 15 mm; Tloušťka 1,5 mm; Délka 2 m; Děrovaná; Pásově zinkováno; Podobné EN 60715 | www.wago.com/210-508 |

Ke stažení

Documentation

Additional Information

| | | | |
|------------------------|-------------|---------------|----------|
| Technical explanations | 03-Apr-2019 | pdf 2,1 MB | Stáhnout |
|------------------------|-------------|---------------|----------|

CAD/CAE-Data

CAD data

| | | |
|----------------------|-----|----------|
| 2D/3D Models 769-227 | URL | Stáhnout |
|----------------------|-----|----------|

CAE data

| | |
|---------------------------|----------|
| EPLAN Data Portal 769-227 | Stáhnout |
|---------------------------|----------|

| | |
|------------------------|----------|
| WSCAD Universe 769-227 | Stáhnout |
|------------------------|----------|

Handling Instructions

Assembly

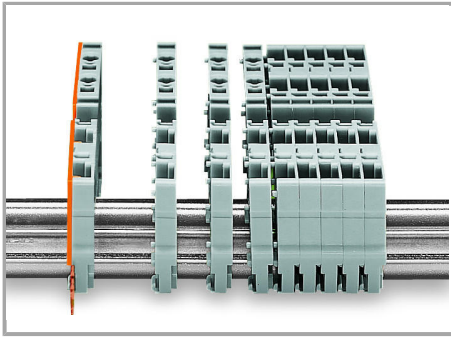

Snap individual carrier terminal blocks onto the carrier rail and slide together.

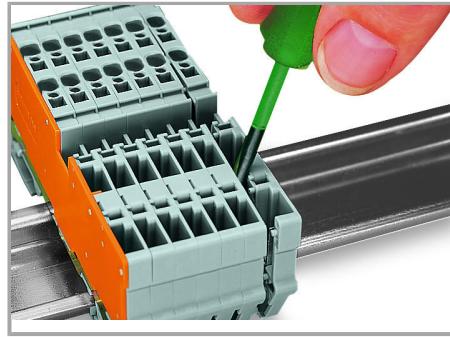

Open the assembly by laterally sliding a block via operating tool and remove terminal block via release lever.

Jumpered

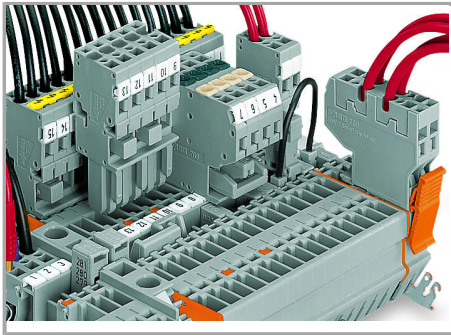

Commoning with adjacent or staggered jumpers –

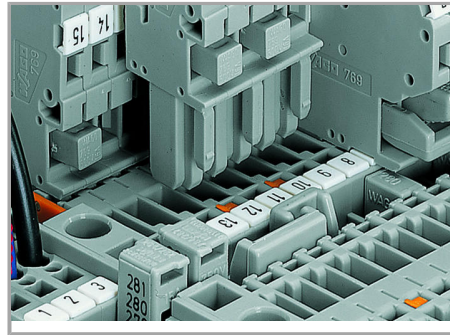

Commoning carrier terminal blocks via staggered jumpers.

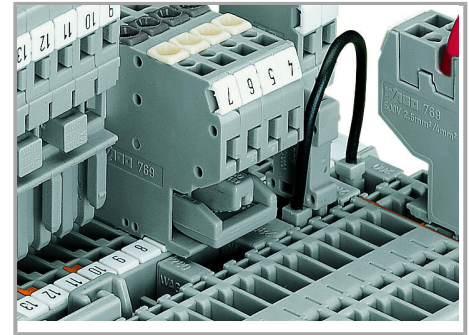

Commoning a 2-conductor female plug via staggered jumper and carrier terminal blocks via adjacent jumpers.

push jumpers down until fully inserted.

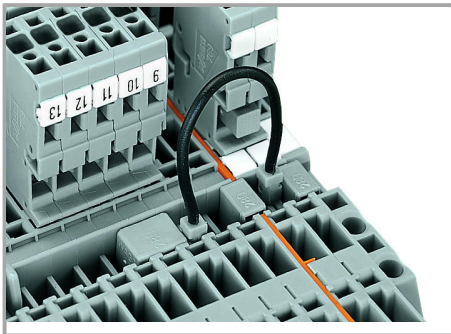

Commoning carrier terminal blocks via push-in type wire jumpers or adjacent jumpers – even over an intermediate plate.

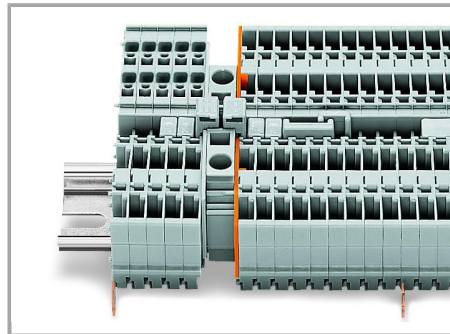

Commoning "supply terminal blocks" (up to 10 mm²/8 AWG) with carrier terminal blocks via step-down jumpers.

Testing

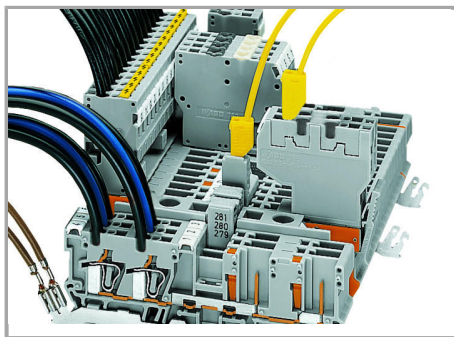

Testing via 2 or 2.3 mm Ø test plugs.

Coding

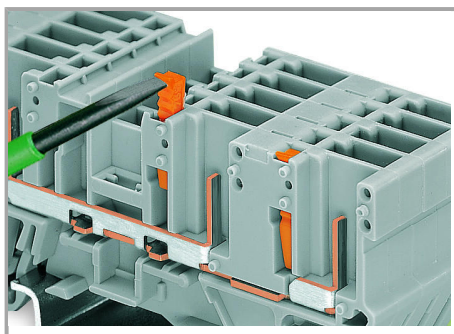

Snap coding pin in proper direction on carrier terminal block.

Shown: Coding pin removal from carrier terminal block.

Locking

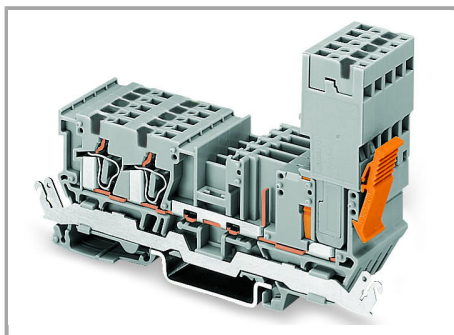

Female plug secured with locking lever on the terminal block side.

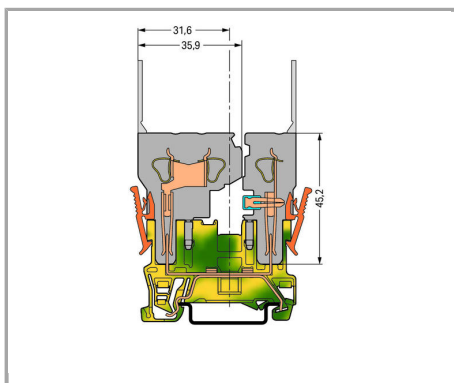

Ground carrier terminal block

Produktová rodina

X-COM

[Zobrazit všechny produkty z rodiny](#)

Změny vyhrazeny.