

## Datový list | Objednací číslo: 769-213

Základní rozpojovací svorka – 1 vodič / 1 pin; S lištou pro stíněný vodič; S dvojitým příčným můstkovým propojením; Na DIN lištu 35 × 15 a 35 × 7,5; 4 mm<sup>2</sup>; CAGE CLAMP®; 4,00 mm<sup>2</sup>; Šedá

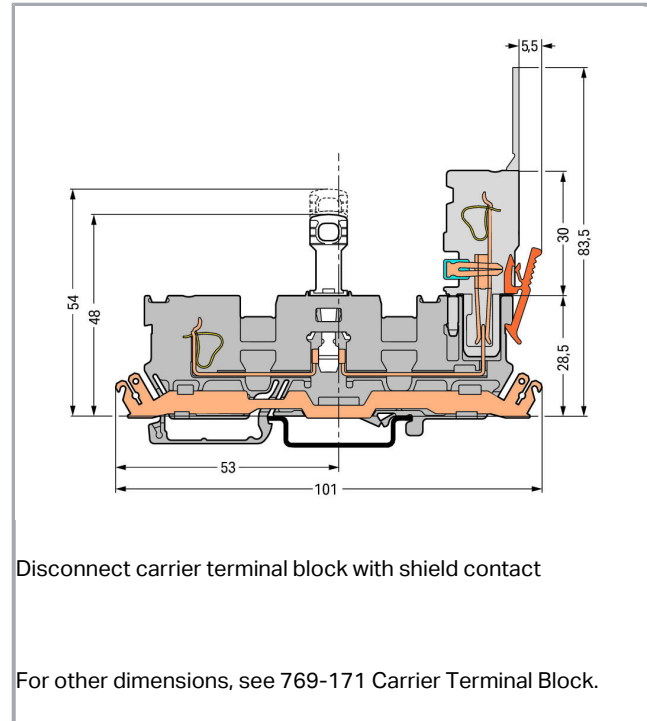

[www.wago.com/769-213](http://www.wago.com/769-213)

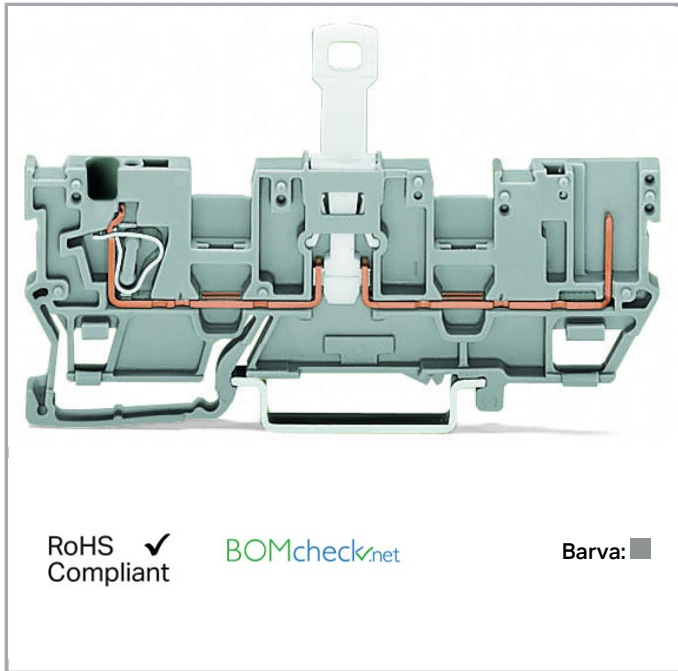

### Data

#### Elektrické parametry

#### Ratings per IEC/EN 60664-1

Návrhové napětí (III / 3)	250 V
Návrhové rázové napětí (III / 3)	4 kV
Jmenovitý proud	16 A
Legenda (návrhové hodnoty)	(III / 3) ≙ kategorie přepětí III / stupeň znečištění 3

#### Údaje o připojení

Připojovací technika	CAGE CLAMP®
Způsob ovládání	Ovládací nástroj
Materiály připojitelných vodičů	Měď
Jmenovitý průřez	4 mm <sup>2</sup>
Plný vodič	0,08 ... 4 mm <sup>2</sup> / 28 ... 12 AWG
Jemně laněný vodič	0,08 ... 4 mm <sup>2</sup> / 28 ... 12 AWG
Délka odizolování	8 ... 9 mm / 0.31 ... 0.35 palec
Celkový počet kontaktních míst	1

Celkový počet potenciálů	1
Počet úrovní	1
Způsob zapojení	čelní připojení

### Geometrické údaje

Šířka	5 mm / 0.197 inch
Výška od horní hrany lišty DIN 35	28,5 mm / 1.122 inch
Hloubka	101 mm / 3.976 inch

### Mechanické parametry

Provedení	Horizontální provedení
Způsob montáže	Lišta DIN 35
Úroveň popisování	Středový popis

### Údaje o materiálu



barva	Šedá
Izolační materiál	Polyamid 66 (PA 66)
Požární zatížení	0.181 MJ
Hmotnost	11.9 g

### Obchodní údaje

Product Group	18 (X-COM-System)
Druh balení	BOX
Country of origin	DE
GTIN	4044918934787
Customs Tariff No.	85365080900

### Atesty/certifikáty

#### Specifické atesty jednotlivých států



Logo	Schválení	Doplňkový text schválení	Název certifikátu
	CCA DEKRA Certification B.V.	EN 60947	NTR NL- 7626
	CSA DEKRA Certification B.V.	C22.2 No. 158	1101144
	KEMA/KEUR DEKRA Certification B.V.	EN 60947	2190419.01



## Atesty pro použití v lodním průmyslu

Logo	Schválení	Doplňkový text schválení	Název certifikátu
	<b>ABS</b> American Bureau of Shipping	EN 60947	14- HG1293677- PDA
	<b>DNV GL</b> Det Norske Veritas, Germanischer Lloyd	-	TAE00001V2
	<b>LR</b> Lloyds Register	EN 60947	91/20112 (E9)

## Atesty UL

Logo	Schválení	Doplňkový text schválení	Název certifikátu
	<b>UR</b> Underwriters Laboratories Inc.	UL 1977	E45171- 20010720
	<b>UR</b> Underwriters Laboratories Inc.	UL 1059	20190731- E45172

## Kompatibilní produkty

check

 **Obj. č.: 210-136** [www.wago.com/210-136](http://www.wago.com/210-136)  
Zkušební hrot; Ø 2 mm; S 500mm vedením; Červená

 **Obj. č.: 210-137** [www.wago.com/210-137](http://www.wago.com/210-137)  
Zkušební hrot; Ø 2,3 mm; S 500mm vedením; Žlutá

**Jumper**

 **Obj. č.: 249-123** [www.wago.com/249-123](http://www.wago.com/249-123)  
Vodičový můstek; Izolováno; L = 180 mm; Průřez vedení 0,75 mm<sup>2</sup>

 **Obj. č.: 249-125** [www.wago.com/249-125](http://www.wago.com/249-125)  
Vodičový můstek; Izolováno; L = 60 mm; Průřez vedení 0,75 mm<sup>2</sup>

 **Obj. č.: 249-126** [www.wago.com/249-126](http://www.wago.com/249-126)  
Vodičový můstek; Izolováno; L = 110 mm; Průřez vedení 0,75 mm<sup>2</sup>

 **Obj. č.: 249-127** [www.wago.com/249-127](http://www.wago.com/249-127)  
Vodičový můstek; Izolováno; L = 250 mm; Průřez vedení 0,75 mm<sup>2</sup>

 **Obj. č.: 280-402** [www.wago.com/280-402](http://www.wago.com/280-402)  
Příčný můstek; Izolováno; IN = IN svorky; Šedá

 **Obj. č.: 280-409** [www.wago.com/280-409](http://www.wago.com/280-409)  
Příčný můstek ob svorku; Izolováno; IN = IN svorky; Šedá

 **Obj. č.: 780-452** [www.wago.com/780-452](http://www.wago.com/780-452)  
Stupňovitý můstek; Izolováno; Z 1 na 2; Rozteč 5 mm; Vhodný pro 2vodičové pružinové svorkovnice; [www.wago.com/780-452](http://www.wago.com/780-452)  
Šedá

 **Obj. č.: 780-453** [www.wago.com/780-453](http://www.wago.com/780-453)  
Stupňovitý můstek; Izolováno; z 1 na 3; Rozteč 5 mm; Vhodný pro 2vodičové pružinové svorkovnice; [www.wago.com/780-453](http://www.wago.com/780-453)  
Šedá

 **Obj. č.: 780-454** [www.wago.com/780-454](http://www.wago.com/780-454)  
Stupňovitý můstek; Izolováno; Z 1 na 4; Rozteč 5 mm; Vhodný pro 2vodičové pružinové svorkovnice; [www.wago.com/780-454](http://www.wago.com/780-454)  
Šedá

 **Obj. č.: 780-455** [www.wago.com/780-455](http://www.wago.com/780-455)  
Stupňovitý můstek; Izolováno; Z 1 na 5; Rozteč 5 mm; Vhodný pro 2vodičové pružinové svorkovnice; [www.wago.com/780-455](http://www.wago.com/780-455)  
Šedá

 **Obj. č.: 780-456** [www.wago.com/780-456](http://www.wago.com/780-456)  
Stupňovitý můstek; Izolováno; Z 1 na 6; Rozteč 5 mm; Vhodný pro 2vodičové pružinové svorkovnice; [www.wago.com/780-456](http://www.wago.com/780-456)  
Šedá

 **Obj. č.: 780-457** [www.wago.com/780-457](http://www.wago.com/780-457)  
Stupňovitý můstek; Izolováno; Z 1 na 7; Rozteč 5 mm; Vhodný pro 2vodičové pružinové svorkovnice; [www.wago.com/780-457](http://www.wago.com/780-457)  
Šedá

 **Obj. č.: 780-458** [www.wago.com/780-458](http://www.wago.com/780-458)  
Stupňovitý můstek; Izolováno; Z 1 na 8; Rozteč 5 mm; Vhodný pro 2vodičové pružinové svorkovnice; [www.wago.com/780-458](http://www.wago.com/780-458)  
Šedá



**End plate**

 **Obj. č.: 769-311** [www.wago.com/769-311](http://www.wago.com/769-311)  
Koncová bočnice a separátor; Tloušťka 1,1 mm; Šedá

 **Obj. č.: 769-312** [www.wago.com/769-312](http://www.wago.com/769-312)  
Koncová bočnice a separátor; Tloušťka 1,1 mm; Oranžová

 **Obj. č.: 769-314** [www.wago.com/769-314](http://www.wago.com/769-314)  
Přepážka; Tloušťka 1,1 mm; S přesahem; Oranžová











## Insulation stop















	<b>Obj. č.: 769-470</b> Izolační zarážka; 0,08–0,2 mm <sup>2</sup> „e“ (0,14 mm <sup>2</sup> „f“); 5 ks/pás; Bílá	<a href="http://www.wago.com/769-470">www.wago.com/769-470</a>
	<b>Obj. č.: 769-471</b> Izolační zarážka; 0,25–0,5 mm <sup>2</sup> ; 5 ks/pás; Světle šedá	<a href="http://www.wago.com/769-471">www.wago.com/769-471</a>
	<b>Obj. č.: 769-472</b> Izolační zarážka; 0,75–1 mm <sup>2</sup> ; 5 ks/pás; Tmavě šedá	<a href="http://www.wago.com/769-472">www.wago.com/769-472</a>















## assembling

	<b>Obj. č.: 209-106</b> Držák; K izolované montáži nosných lišt DIN 35; Šedá	<a href="http://www.wago.com/209-106">www.wago.com/209-106</a>
--	---	--

## Female plug

	<b>Obj. č.: 769-101</b> 1 vodičová pružinová svorkovnice; 4 mm <sup>2</sup> ; 1pól.; 4,00 mm <sup>2</sup> ; Šedá	<a href="http://www.wago.com/769-101">www.wago.com/769-101</a>
	<b>Obj. č.: 769-101/000-006</b> 1 vodičová pružinová svorkovnice; 4 mm <sup>2</sup> ; 1pól.; 4,00 mm <sup>2</sup> ; Modrá	<a href="http://www.wago.com/769-101/000-006">www.wago.com/769-101/000-006</a>
	<b>Obj. č.: 769-101/000-016</b> 1 vodičová pružinová svorkovnice; 4 mm <sup>2</sup> ; 1pól.; 4,00 mm <sup>2</sup> ; Zeleno-žlutá	<a href="http://www.wago.com/769-101/000-016">www.wago.com/769-101/000-016</a>
	<b>Obj. č.: 769-101/022-000</b> 1 vodičová pružinová svorkovnice; Úhlové provedení; 4 mm <sup>2</sup> ; 1pól.; 4,00 mm <sup>2</sup> ; Šedá	<a href="http://www.wago.com/769-101/022-000">www.wago.com/769-101/022-000</a>
	<b>Obj. č.: 769-101/022-016</b> 1 vodičová pružinová svorkovnice; Úhlové provedení; 4 mm <sup>2</sup> ; 1pól.; 4,00 mm <sup>2</sup> ; Zeleno-žlutá	<a href="http://www.wago.com/769-101/022-016">www.wago.com/769-101/022-016</a>
	<b>Obj. č.: 769-102</b> 1 vodičová pružinová svorkovnice; 4 mm <sup>2</sup> ; 2pól.; 4,00 mm <sup>2</sup> ; Šedá	<a href="http://www.wago.com/769-102">www.wago.com/769-102</a>
	<b>Obj. č.: 769-102/000-006</b> 1 vodičová pružinová svorkovnice; 4 mm <sup>2</sup> ; 2pól.; 4,00 mm <sup>2</sup> ; Modrá	<a href="http://www.wago.com/769-102/000-006">www.wago.com/769-102/000-006</a>
	<b>Obj. č.: 769-102/000-036</b> 1 vodičová pružinová svorkovnice; 4 mm <sup>2</sup> ; 2pól.; 4,00 mm <sup>2</sup> ; Šedá / zelená – žlutá	<a href="http://www.wago.com/769-102/000-036">www.wago.com/769-102/000-036</a>
	<b>Obj. č.: 769-102/000-037</b> 1 vodičová pružinová svorkovnice; 4 mm <sup>2</sup> ; 2pól.; 4,00 mm <sup>2</sup> ; Zelená – žlutá / šedá	<a href="http://www.wago.com/769-102/000-037">www.wago.com/769-102/000-037</a>
	<b>Obj. č.: 769-102/022-000</b> 1 vodičová pružinová svorkovnice; Úhlové provedení; 4 mm <sup>2</sup> ; 2pól.; 4,00 mm <sup>2</sup> ; Šedá	<a href="http://www.wago.com/769-102/022-000">www.wago.com/769-102/022-000</a>
	<b>Obj. č.: 769-103</b> 1 vodičová pružinová svorkovnice; 4 mm <sup>2</sup> ; 3pól.; 4,00 mm <sup>2</sup> ; Šedá	<a href="http://www.wago.com/769-103">www.wago.com/769-103</a>

	<p><b>Obj. č.: 769-103/000-006</b> 1 vodičová pružinová svorkovnice; 4 mm<sup>2</sup>; 3pól.; 4,00 mm<sup>2</sup>; Modrá</p>	<a href="http://www.wago.com/769-103/000-006">www.wago.com/769-103/000-006</a>
	<p><b>Obj. č.: 769-103/000-036</b> 1 vodičová pružinová svorkovnice; 4 mm<sup>2</sup>; 3pól.; 4,00 mm<sup>2</sup>; Šedá / zelená – žlutá</p>	<a href="http://www.wago.com/769-103/000-036">www.wago.com/769-103/000-036</a>
	<p><b>Obj. č.: 769-103/000-037</b> 1 vodičová pružinová svorkovnice; 4 mm<sup>2</sup>; 3pól.; 4,00 mm<sup>2</sup>; Zelená – žlutá / šedá</p>	<a href="http://www.wago.com/769-103/000-037">www.wago.com/769-103/000-037</a>
	<p><b>Obj. č.: 769-103/000-038</b> 1 vodičová pružinová svorkovnice; 4 mm<sup>2</sup>; 3pól.; 4,00 mm<sup>2</sup>; Šedá / modrá / zelená – žlutá</p>	<a href="http://www.wago.com/769-103/000-038">www.wago.com/769-103/000-038</a>
	<p><b>Obj. č.: 769-103/000-039</b> 1 vodičová pružinová svorkovnice; 4 mm<sup>2</sup>; 3pól.; 4,00 mm<sup>2</sup>; Zelená – žlutá, modrá, šedá</p>	<a href="http://www.wago.com/769-103/000-039">www.wago.com/769-103/000-039</a>
	<p><b>Obj. č.: 769-103/022-000</b> 1 vodičová pružinová svorkovnice; Úhlové provedení; 4 mm<sup>2</sup>; 3pól.; 4,00 mm<sup>2</sup>; Šedá</p>	<a href="http://www.wago.com/769-103/022-000">www.wago.com/769-103/022-000</a>
	<p><b>Obj. č.: 769-104</b> 1 vodičová pružinová svorkovnice; 4 mm<sup>2</sup>; 4pól.; 4,00 mm<sup>2</sup>; Šedá</p>	<a href="http://www.wago.com/769-104">www.wago.com/769-104</a>
	<p><b>Obj. č.: 769-104/000-006</b> 1 vodičová pružinová svorkovnice; 4 mm<sup>2</sup>; 4pól.; 4,00 mm<sup>2</sup>; Modrá</p>	<a href="http://www.wago.com/769-104/000-006">www.wago.com/769-104/000-006</a>
	<p><b>Obj. č.: 769-104/000-036</b> 1 vodičová pružinová svorkovnice; 4 mm<sup>2</sup>; 4pól.; 4,00 mm<sup>2</sup>; Šedá / zelená – žlutá</p>	<a href="http://www.wago.com/769-104/000-036">www.wago.com/769-104/000-036</a>
	<p><b>Obj. č.: 769-104/000-037</b> 1 vodičová pružinová svorkovnice; 4 mm<sup>2</sup>; 4pól.; 4,00 mm<sup>2</sup>; Zelená – žlutá / šedá</p>	<a href="http://www.wago.com/769-104/000-037">www.wago.com/769-104/000-037</a>
	<p><b>Obj. č.: 769-104/000-038</b> 1 vodičová pružinová svorkovnice; 4 mm<sup>2</sup>; 4pól.; 4,00 mm<sup>2</sup>; Šedá / modrá / zelená – žlutá</p>	<a href="http://www.wago.com/769-104/000-038">www.wago.com/769-104/000-038</a>
	<p><b>Obj. č.: 769-104/000-039</b> 1 vodičová pružinová svorkovnice; 4 mm<sup>2</sup>; 4pól.; 4,00 mm<sup>2</sup>; Zelená – žlutá, modrá, šedá</p>	<a href="http://www.wago.com/769-104/000-039">www.wago.com/769-104/000-039</a>
	<p><b>Obj. č.: 769-104/022-000</b> 1 vodičová pružinová svorkovnice; Úhlové provedení; 4 mm<sup>2</sup>; 4pól.; 4,00 mm<sup>2</sup>; Šedá</p>	<a href="http://www.wago.com/769-104/022-000">www.wago.com/769-104/022-000</a>
	<p><b>Obj. č.: 769-105</b> 1 vodičová pružinová svorkovnice; 4 mm<sup>2</sup>; 5pól.; 4,00 mm<sup>2</sup>; Šedá</p>	<a href="http://www.wago.com/769-105">www.wago.com/769-105</a>
	<p><b>Obj. č.: 769-105/000-006</b> 1 vodičová pružinová svorkovnice; 4 mm<sup>2</sup>; 5pól.; 4,00 mm<sup>2</sup>; Modrá</p>	<a href="http://www.wago.com/769-105/000-006">www.wago.com/769-105/000-006</a>

	<b>Obj. č.: 769-105/000-036</b> 1 vodičová pružinová svorkovnice; 4 mm <sup>2</sup> ; 5pól.; 4,00 mm <sup>2</sup> ; Šedá / zelená – žlutá	<a href="http://www.wago.com/769-105/000-036">www.wago.com/769-105/000-036</a>
	<b>Obj. č.: 769-105/000-037</b> 1 vodičová pružinová svorkovnice; 4 mm <sup>2</sup> ; 5pól.; 4,00 mm <sup>2</sup> ; Zelená – žlutá / šedá	<a href="http://www.wago.com/769-105/000-037">www.wago.com/769-105/000-037</a>
	<b>Obj. č.: 769-105/000-038</b> 1 vodičová pružinová svorkovnice; 4 mm <sup>2</sup> ; 5pól.; 4,00 mm <sup>2</sup> ; Šedá / modrá / zelená – žlutá	<a href="http://www.wago.com/769-105/000-038">www.wago.com/769-105/000-038</a>
	<b>Obj. č.: 769-105/000-039</b> 1 vodičová pružinová svorkovnice; 4 mm <sup>2</sup> ; 5pól.; 4,00 mm <sup>2</sup> ; Zelená – žlutá, modrá, šedá	<a href="http://www.wago.com/769-105/000-039">www.wago.com/769-105/000-039</a>
	<b>Obj. č.: 769-105/022-000</b> 1 vodičová pružinová svorkovnice; Úhlové provedení; 4 mm <sup>2</sup> ; 5pól.; 4,00 mm <sup>2</sup> ; Šedá	<a href="http://www.wago.com/769-105/022-000">www.wago.com/769-105/022-000</a>
	<b>Obj. č.: 769-106</b> 1 vodičová pružinová svorkovnice; 4 mm <sup>2</sup> ; 6pól.; 4,00 mm <sup>2</sup> ; Šedá	<a href="http://www.wago.com/769-106">www.wago.com/769-106</a>
	<b>Obj. č.: 769-106/000-006</b> 1 vodičová pružinová svorkovnice; 4 mm <sup>2</sup> ; 6pól.; 4,00 mm <sup>2</sup> ; Modrá	<a href="http://www.wago.com/769-106/000-006">www.wago.com/769-106/000-006</a>
	<b>Obj. č.: 769-106/000-036</b> 1 vodičová pružinová svorkovnice; 4 mm <sup>2</sup> ; 6pól.; 4,00 mm <sup>2</sup> ; Šedá / zelená – žlutá	<a href="http://www.wago.com/769-106/000-036">www.wago.com/769-106/000-036</a>
	<b>Obj. č.: 769-106/000-037</b> 1 vodičová pružinová svorkovnice; 4 mm <sup>2</sup> ; 6pól.; 4,00 mm <sup>2</sup> ; Zelená – žlutá / šedá	<a href="http://www.wago.com/769-106/000-037">www.wago.com/769-106/000-037</a>
	<b>Obj. č.: 769-106/000-038</b> 1 vodičová pružinová svorkovnice; 4 mm <sup>2</sup> ; 6pól.; 4,00 mm <sup>2</sup> ; Šedá / modrá / zelená – žlutá	<a href="http://www.wago.com/769-106/000-038">www.wago.com/769-106/000-038</a>
	<b>Obj. č.: 769-106/000-039</b> 1 vodičová pružinová svorkovnice; 4 mm <sup>2</sup> ; 6pól.; 4,00 mm <sup>2</sup> ; Zelená – žlutá, modrá, šedá	<a href="http://www.wago.com/769-106/000-039">www.wago.com/769-106/000-039</a>
	<b>Obj. č.: 769-106/022-000</b> 1 vodičová pružinová svorkovnice; Úhlové provedení; 4 mm <sup>2</sup> ; 6pól.; 4,00 mm <sup>2</sup> ; Šedá	<a href="http://www.wago.com/769-106/022-000">www.wago.com/769-106/022-000</a>
	<b>Obj. č.: 769-107</b> 1 vodičová pružinová svorkovnice; 4 mm <sup>2</sup> ; 7pól.; 4,00 mm <sup>2</sup> ; Šedá	<a href="http://www.wago.com/769-107">www.wago.com/769-107</a>
	<b>Obj. č.: 769-107/000-006</b> 1 vodičová pružinová svorkovnice; 4 mm <sup>2</sup> ; 7pól.; 4,00 mm <sup>2</sup> ; Modrá	<a href="http://www.wago.com/769-107/000-006">www.wago.com/769-107/000-006</a>
	<b>Obj. č.: 769-107/000-036</b> 1 vodičová pružinová svorkovnice; 4 mm <sup>2</sup> ; 7pól.; 4,00 mm <sup>2</sup> ; Šedá / zelená – žlutá	<a href="http://www.wago.com/769-107/000-036">www.wago.com/769-107/000-036</a>



**Obj. č.: 769-107/000-037**

1 vodičová pružinová svorkovnice; 4 mm<sup>2</sup>; 7pól.; 4,00 mm<sup>2</sup>; Zelená – žlutá / šedá

[www.wago.com/769-107/000-037](http://www.wago.com/769-107/000-037)



**Obj. č.: 769-107/000-038**

1 vodičová pružinová svorkovnice; 4 mm<sup>2</sup>; 7pól.; 4,00 mm<sup>2</sup>; Šedá / modrá / zelená – žlutá

[www.wago.com/769-107/000-038](http://www.wago.com/769-107/000-038)



**Obj. č.: 769-107/000-039**

1 vodičová pružinová svorkovnice; 4 mm<sup>2</sup>; 7pól.; 4,00 mm<sup>2</sup>; Zelená – žlutá, modrá, šedá

[www.wago.com/769-107/000-039](http://www.wago.com/769-107/000-039)



**Obj. č.: 769-107/022-000**

1 vodičová pružinová svorkovnice; Úhlové provedení; 4 mm<sup>2</sup>; 7pól.; 4,00 mm<sup>2</sup>; Šedá

[www.wago.com/769-107/022-000](http://www.wago.com/769-107/022-000)



**Obj. č.: 769-108**

1 vodičová pružinová svorkovnice; 4 mm<sup>2</sup>; 8pól.; 4,00 mm<sup>2</sup>; Šedá

[www.wago.com/769-108](http://www.wago.com/769-108)



**Obj. č.: 769-108/000-006**

1 vodičová pružinová svorkovnice; 4 mm<sup>2</sup>; 8pól.; 4,00 mm<sup>2</sup>; Modrá

[www.wago.com/769-108/000-006](http://www.wago.com/769-108/000-006)



**Obj. č.: 769-108/000-036**

1 vodičová pružinová svorkovnice; 4 mm<sup>2</sup>; 8pól.; 4,00 mm<sup>2</sup>; Šedá / zelená – žlutá

[www.wago.com/769-108/000-036](http://www.wago.com/769-108/000-036)



**Obj. č.: 769-108/000-037**

1 vodičová pružinová svorkovnice; 4 mm<sup>2</sup>; 8pól.; 4,00 mm<sup>2</sup>; Zelená – žlutá / šedá

[www.wago.com/769-108/000-037](http://www.wago.com/769-108/000-037)



**Obj. č.: 769-108/000-038**

1 vodičová pružinová svorkovnice; 4 mm<sup>2</sup>; 8pól.; 4,00 mm<sup>2</sup>; Šedá / modrá / zelená – žlutá

[www.wago.com/769-108/000-038](http://www.wago.com/769-108/000-038)



**Obj. č.: 769-108/000-039**

1 vodičová pružinová svorkovnice; 4 mm<sup>2</sup>; 8pól.; 4,00 mm<sup>2</sup>; Zelená – žlutá, modrá, šedá

[www.wago.com/769-108/000-039](http://www.wago.com/769-108/000-039)



**Obj. č.: 769-108/022-000**

1 vodičová pružinová svorkovnice; Úhlové provedení; 4 mm<sup>2</sup>; 8pól.; 4,00 mm<sup>2</sup>; Šedá

[www.wago.com/769-108/022-000](http://www.wago.com/769-108/022-000)



**Obj. č.: 769-109**

1 vodičová pružinová svorkovnice; 4 mm<sup>2</sup>; 9pól.; 4,00 mm<sup>2</sup>; Šedá

[www.wago.com/769-109](http://www.wago.com/769-109)



**Obj. č.: 769-109/000-006**

1 vodičová pružinová svorkovnice; 4 mm<sup>2</sup>; 9pól.; 4,00 mm<sup>2</sup>; Modrá

[www.wago.com/769-109/000-006](http://www.wago.com/769-109/000-006)



**Obj. č.: 769-109/000-036**

1 vodičová pružinová svorkovnice; 4 mm<sup>2</sup>; 9pól.; 4,00 mm<sup>2</sup>; Šedá / zelená – žlutá

[www.wago.com/769-109/000-036](http://www.wago.com/769-109/000-036)



**Obj. č.: 769-109/000-037**

1 vodičová pružinová svorkovnice; 4 mm<sup>2</sup>; 9pól.; 4,00 mm<sup>2</sup>; Zelená – žlutá / šedá

[www.wago.com/769-109/000-037](http://www.wago.com/769-109/000-037)





**Obj. č.: 769-109/000-038**  
1 vodičová pružinová svorkovnice; 4 mm<sup>2</sup>; 9pól.; 4,00 mm<sup>2</sup>; Šedá / modrá / zelená – žlutá

[www.wago.com/769-109/000-038](http://www.wago.com/769-109/000-038)



**Obj. č.: 769-109/000-039**  
1 vodičová pružinová svorkovnice; 4 mm<sup>2</sup>; 9pól.; 4,00 mm<sup>2</sup>; Zelená – žlutá, modrá, šedá

[www.wago.com/769-109/000-039](http://www.wago.com/769-109/000-039)



**Obj. č.: 769-109/022-000**  
1 vodičová pružinová svorkovnice; Úhlové provedení; 4 mm<sup>2</sup>; 9pól.; 4,00 mm<sup>2</sup>; Šedá

[www.wago.com/769-109/022-000](http://www.wago.com/769-109/022-000)



**Obj. č.: 769-110**  
1 vodičová pružinová svorkovnice; 4 mm<sup>2</sup>; 10pól.; 4,00 mm<sup>2</sup>; Šedá

[www.wago.com/769-110](http://www.wago.com/769-110)



**Obj. č.: 769-110/000-006**  
1 vodičová pružinová svorkovnice; 4 mm<sup>2</sup>; 10pól.; 4,00 mm<sup>2</sup>; Modrá

[www.wago.com/769-110/000-006](http://www.wago.com/769-110/000-006)



**Obj. č.: 769-110/000-036**  
1 vodičová pružinová svorkovnice; 4 mm<sup>2</sup>; 10pól.; 4,00 mm<sup>2</sup>; Šedá / zelená – žlutá

[www.wago.com/769-110/000-036](http://www.wago.com/769-110/000-036)



**Obj. č.: 769-110/000-037**  
1 vodičová pružinová svorkovnice; 4 mm<sup>2</sup>; 10pól.; 4,00 mm<sup>2</sup>; Zelená – žlutá / šedá

[www.wago.com/769-110/000-037](http://www.wago.com/769-110/000-037)



**Obj. č.: 769-110/000-038**  
1 vodičová pružinová svorkovnice; 4 mm<sup>2</sup>; 10pól.; 4,00 mm<sup>2</sup>; Šedá / modrá / zelená – žlutá

[www.wago.com/769-110/000-038](http://www.wago.com/769-110/000-038)



**Obj. č.: 769-110/000-039**  
1 vodičová pružinová svorkovnice; 4 mm<sup>2</sup>; 10pól.; 4,00 mm<sup>2</sup>; Zelená – žlutá, modrá, šedá

[www.wago.com/769-110/000-039](http://www.wago.com/769-110/000-039)



**Obj. č.: 769-110/022-000**  
1 vodičová pružinová svorkovnice; Úhlové provedení; 4 mm<sup>2</sup>; 10pól.; 4,00 mm<sup>2</sup>; Šedá

[www.wago.com/769-110/022-000](http://www.wago.com/769-110/022-000)



**Obj. č.: 769-111**  
1 vodičová pružinová svorkovnice; 4 mm<sup>2</sup>; 11pól.; 4,00 mm<sup>2</sup>; Šedá

[www.wago.com/769-111](http://www.wago.com/769-111)



**Obj. č.: 769-111/000-006**  
1 vodičová pružinová svorkovnice; 4 mm<sup>2</sup>; 11pól.; 4,00 mm<sup>2</sup>; Modrá

[www.wago.com/769-111/000-006](http://www.wago.com/769-111/000-006)



**Obj. č.: 769-111/000-036**  
1 vodičová pružinová svorkovnice; 4 mm<sup>2</sup>; 11pól.; 4,00 mm<sup>2</sup>; Šedá / zelená – žlutá

[www.wago.com/769-111/000-036](http://www.wago.com/769-111/000-036)

















**Obj. č.: 769-111/000-037**  
1 vodičová pružinová svorkovnice; 4 mm<sup>2</sup>; 11pól.; 4,00 mm<sup>2</sup>; Zelená – žlutá / šedá















[www.wago.com/769-111/000-037](http://www.wago.com/769-111/000-037)



**Obj. č.: 769-111/000-038**  
1 vodičová pružinová svorkovnice; 4 mm<sup>2</sup>; 11pól.; 4,00 mm<sup>2</sup>; Šedá / modrá / zelená – žlutá

[www.wago.com/769-111/000-038](http://www.wago.com/769-111/000-038)

	<p><b>Obj. č.: 769-111/000-039</b> 1 vodičová pružinová svorkovnice; 4 mm<sup>2</sup>; 11pól.; 4,00 mm<sup>2</sup>; Zelená – žlutá, modrá, šedá</p>	<a href="http://www.wago.com/769-111/000-039">www.wago.com/769-111/000-039</a>
	<p><b>Obj. č.: 769-111/022-000</b> 1 vodičová pružinová svorkovnice; Úhlové provedení; 4 mm<sup>2</sup>; 11pól.; 4,00 mm<sup>2</sup>; Šedá</p>	<a href="http://www.wago.com/769-111/022-000">www.wago.com/769-111/022-000</a>
	<p><b>Obj. č.: 769-112</b> 1 vodičová pružinová svorkovnice; 4 mm<sup>2</sup>; 12pól.; 4,00 mm<sup>2</sup>; Šedá</p>	<a href="http://www.wago.com/769-112">www.wago.com/769-112</a>
	<p><b>Obj. č.: 769-112/000-006</b> 1 vodičová pružinová svorkovnice; 4 mm<sup>2</sup>; 12pól.; 4,00 mm<sup>2</sup>; Modrá</p>	<a href="http://www.wago.com/769-112/000-006">www.wago.com/769-112/000-006</a>
	<p><b>Obj. č.: 769-112/000-036</b> 1 vodičová pružinová svorkovnice; 4 mm<sup>2</sup>; 12pól.; 4,00 mm<sup>2</sup>; Šedá / zelená – žlutá</p>	<a href="http://www.wago.com/769-112/000-036">www.wago.com/769-112/000-036</a>
	<p><b>Obj. č.: 769-112/000-037</b> 1 vodičová pružinová svorkovnice; 4 mm<sup>2</sup>; 12pól.; 4,00 mm<sup>2</sup>; Zelená – žlutá / šedá</p>	<a href="http://www.wago.com/769-112/000-037">www.wago.com/769-112/000-037</a>
	<p><b>Obj. č.: 769-112/000-038</b> 1 vodičová pružinová svorkovnice; 4 mm<sup>2</sup>; 12pól.; 4,00 mm<sup>2</sup>; Šedá / modrá / zelená – žlutá</p>	<a href="http://www.wago.com/769-112/000-038">www.wago.com/769-112/000-038</a>
	<p><b>Obj. č.: 769-112/000-039</b> 1 vodičová pružinová svorkovnice; 4 mm<sup>2</sup>; 12pól.; 4,00 mm<sup>2</sup>; Zelená – žlutá, modrá, šedá</p>	<a href="http://www.wago.com/769-112/000-039">www.wago.com/769-112/000-039</a>
	<p><b>Obj. č.: 769-112/022-000</b> 1 vodičová pružinová svorkovnice; Úhlové provedení; 4 mm<sup>2</sup>; 12pól.; 4,00 mm<sup>2</sup>; Šedá</p>	<a href="http://www.wago.com/769-112/022-000">www.wago.com/769-112/022-000</a>
	<p><b>Obj. č.: 769-113</b> 1 vodičová pružinová svorkovnice; 4 mm<sup>2</sup>; 13pól.; 4,00 mm<sup>2</sup>; Šedá</p>	<a href="http://www.wago.com/769-113">www.wago.com/769-113</a>
	<p><b>Obj. č.: 769-113/000-036</b> 1 vodičová pružinová svorkovnice; 4 mm<sup>2</sup>; 13pól.; 4,00 mm<sup>2</sup>; Šedá / zelená – žlutá</p>	<a href="http://www.wago.com/769-113/000-036">www.wago.com/769-113/000-036</a>
	<p><b>Obj. č.: 769-113/000-037</b> 1 vodičová pružinová svorkovnice; 4 mm<sup>2</sup>; 13pól.; 4,00 mm<sup>2</sup>; Zelená – žlutá / šedá</p>	<a href="http://www.wago.com/769-113/000-037">www.wago.com/769-113/000-037</a>
	<p><b>Obj. č.: 769-113/000-038</b> 1 vodičová pružinová svorkovnice; 4 mm<sup>2</sup>; 13pól.; 4,00 mm<sup>2</sup>; Šedá / modrá / zelená – žlutá</p>	<a href="http://www.wago.com/769-113/000-038">www.wago.com/769-113/000-038</a>
	<p><b>Obj. č.: 769-113/000-039</b> 1 vodičová pružinová svorkovnice; 4 mm<sup>2</sup>; 13pól.; 4,00 mm<sup>2</sup>; Zelená – žlutá, modrá, šedá</p>	<a href="http://www.wago.com/769-113/000-039">www.wago.com/769-113/000-039</a>
	<p><b>Obj. č.: 769-113/022-000</b> 1 vodičová pružinová svorkovnice; Úhlové provedení; 4 mm<sup>2</sup>; 13pól.; 4,00 mm<sup>2</sup>; Šedá</p>	<a href="http://www.wago.com/769-113/022-000">www.wago.com/769-113/022-000</a>

	<b>Obj. č.: 769-114</b> 1 vodičová pružinová svorkovnice; 4 mm <sup>2</sup> ; 14pól.; 4,00 mm <sup>2</sup> ; Šedá	<a href="http://www.wago.com/769-114">www.wago.com/769-114</a>
	<b>Obj. č.: 769-114/000-006</b> 1 vodičová pružinová svorkovnice; 4 mm <sup>2</sup> ; 14pól.; 4,00 mm <sup>2</sup> ; Modrá	<a href="http://www.wago.com/769-114/000-006">www.wago.com/769-114/000-006</a>
	<b>Obj. č.: 769-114/000-036</b> 1 vodičová pružinová svorkovnice; 4 mm <sup>2</sup> ; 14pól.; 4,00 mm <sup>2</sup> ; Šedá / zelená – žlutá	<a href="http://www.wago.com/769-114/000-036">www.wago.com/769-114/000-036</a>
	<b>Obj. č.: 769-114/000-037</b> 1 vodičová pružinová svorkovnice; 4 mm <sup>2</sup> ; 14pól.; 4,00 mm <sup>2</sup> ; Zelená – žlutá / šedá	<a href="http://www.wago.com/769-114/000-037">www.wago.com/769-114/000-037</a>
	<b>Obj. č.: 769-114/000-038</b> 1 vodičová pružinová svorkovnice; 4 mm <sup>2</sup> ; 14pól.; 4,00 mm <sup>2</sup> ; Šedá / modrá / zelená – žlutá	<a href="http://www.wago.com/769-114/000-038">www.wago.com/769-114/000-038</a>
	<b>Obj. č.: 769-114/000-039</b> 1 vodičová pružinová svorkovnice; 4 mm <sup>2</sup> ; 14pól.; 4,00 mm <sup>2</sup> ; Zelená – žlutá, modrá, šedá	<a href="http://www.wago.com/769-114/000-039">www.wago.com/769-114/000-039</a>
	<b>Obj. č.: 769-114/022-000</b> 1 vodičová pružinová svorkovnice; Úhlové provedení; 4 mm <sup>2</sup> ; 14pól.; 4,00 mm <sup>2</sup> ; Šedá	<a href="http://www.wago.com/769-114/022-000">www.wago.com/769-114/022-000</a>
	<b>Obj. č.: 769-115</b> 1 vodičová pružinová svorkovnice; 4 mm <sup>2</sup> ; 15pól.; 4,00 mm <sup>2</sup> ; Šedá	<a href="http://www.wago.com/769-115">www.wago.com/769-115</a>
	<b>Obj. č.: 769-115/000-036</b> 1 vodičová pružinová svorkovnice; 4 mm <sup>2</sup> ; 15pól.; 4,00 mm <sup>2</sup> ; Šedá / zelená – žlutá	<a href="http://www.wago.com/769-115/000-036">www.wago.com/769-115/000-036</a>
	<b>Obj. č.: 769-115/000-037</b> 1 vodičová pružinová svorkovnice; 4 mm <sup>2</sup> ; 15pól.; 4,00 mm <sup>2</sup> ; Zelená – žlutá / šedá	<a href="http://www.wago.com/769-115/000-037">www.wago.com/769-115/000-037</a>
	<b>Obj. č.: 769-115/000-038</b> 1 vodičová pružinová svorkovnice; 4 mm <sup>2</sup> ; 15pól.; 4,00 mm <sup>2</sup> ; Šedá / modrá / zelená – žlutá	<a href="http://www.wago.com/769-115/000-038">www.wago.com/769-115/000-038</a>
	<b>Obj. č.: 769-115/000-039</b> 1 vodičová pružinová svorkovnice; 4 mm <sup>2</sup> ; 15pól.; 4,00 mm <sup>2</sup> ; Zelená – žlutá, modrá, šedá	<a href="http://www.wago.com/769-115/000-039">www.wago.com/769-115/000-039</a>
	<b>Obj. č.: 769-115/022-000</b> 1 vodičová pružinová svorkovnice; Úhlové provedení; 4 mm <sup>2</sup> ; 15pól.; 4,00 mm <sup>2</sup> ; Šedá	<a href="http://www.wago.com/769-115/022-000">www.wago.com/769-115/022-000</a>
	<b>Obj. č.: 769-121</b> 2 vodičová pružinová svorkovnice; 4 mm <sup>2</sup> ; 1pól.; 4,00 mm <sup>2</sup> ; Šedá	<a href="http://www.wago.com/769-121">www.wago.com/769-121</a>
	<b>Obj. č.: 769-121/000-016</b> 2 vodičová pružinová svorkovnice; 4 mm <sup>2</sup> ; 1pól.; 4,00 mm <sup>2</sup> ; Zeleno-žlutá	<a href="http://www.wago.com/769-121/000-016">www.wago.com/769-121/000-016</a>
	<b>Obj. č.: 769-122</b> 2 vodičová pružinová svorkovnice; 4 mm <sup>2</sup> ; 2pól.; 4,00 mm <sup>2</sup> ; Šedá	<a href="http://www.wago.com/769-122">www.wago.com/769-122</a>



**Obj. č.: 769-123**  
2vodičová pružinová svorkovnice; 4 mm<sup>2</sup>; 3pól.; 4,00 mm<sup>2</sup>; Šedá

[www.wago.com/769-123](http://www.wago.com/769-123)



**Obj. č.: 769-124**  
2vodičová pružinová svorkovnice; 4 mm<sup>2</sup>; 4pól.; 4,00 mm<sup>2</sup>; Šedá

[www.wago.com/769-124](http://www.wago.com/769-124)



**Obj. č.: 769-125**  
2vodičová pružinová svorkovnice; 4 mm<sup>2</sup>; 5pól.; 4,00 mm<sup>2</sup>; Šedá

[www.wago.com/769-125](http://www.wago.com/769-125)



**Obj. č.: 769-126**  
2vodičová pružinová svorkovnice; 4 mm<sup>2</sup>; 6pól.; 4,00 mm<sup>2</sup>; Šedá

[www.wago.com/769-126](http://www.wago.com/769-126)



**Obj. č.: 769-127**  
2vodičová pružinová svorkovnice; 4 mm<sup>2</sup>; 7pól.; 4,00 mm<sup>2</sup>; Šedá

[www.wago.com/769-127](http://www.wago.com/769-127)



**Obj. č.: 769-128**  
2vodičová pružinová svorkovnice; 4 mm<sup>2</sup>; 8pól.; 4,00 mm<sup>2</sup>; Šedá

[www.wago.com/769-128](http://www.wago.com/769-128)



**Obj. č.: 769-129**  
2vodičová pružinová svorkovnice; 4 mm<sup>2</sup>; 9pól.; 4,00 mm<sup>2</sup>; Šedá

[www.wago.com/769-129](http://www.wago.com/769-129)



**Obj. č.: 769-130**  
2vodičová pružinová svorkovnice; 4 mm<sup>2</sup>; 10pól.; 4,00 mm<sup>2</sup>; Šedá

[www.wago.com/769-130](http://www.wago.com/769-130)



**Obj. č.: 769-131**  
2vodičová pružinová svorkovnice; 4 mm<sup>2</sup>; 11pól.; 4,00 mm<sup>2</sup>; Šedá

[www.wago.com/769-131](http://www.wago.com/769-131)



**Obj. č.: 769-132**  
2vodičová pružinová svorkovnice; 4 mm<sup>2</sup>; 12pól.; 4,00 mm<sup>2</sup>; Šedá

[www.wago.com/769-132](http://www.wago.com/769-132)



**Obj. č.: 769-133**  
2vodičová pružinová svorkovnice; 4 mm<sup>2</sup>; 13pól.; 4,00 mm<sup>2</sup>; Šedá

[www.wago.com/769-133](http://www.wago.com/769-133)



**Obj. č.: 769-134**  
2vodičová pružinová svorkovnice; 4 mm<sup>2</sup>; 14pól.; 4,00 mm<sup>2</sup>; Šedá

[www.wago.com/769-134](http://www.wago.com/769-134)



**Obj. č.: 769-135**  
2vodičová pružinová svorkovnice; 4 mm<sup>2</sup>; 15pól.; 4,00 mm<sup>2</sup>; Šedá

[www.wago.com/769-135](http://www.wago.com/769-135)



**ferrule**



**Obj. č.: 216-101**  
Dutinka; Objímka na 0,5 mm<sup>2</sup> / AWG 22; Bez plastového límce; Galvanicky pocínováno

[www.wago.com/216-101](http://www.wago.com/216-101)



**Obj. č.: 216-102**  
Dutinka; Objímka na 0,75 mm<sup>2</sup> / AWG 20; Bez plastového límce; Galvanicky pocínováno

[www.wago.com/216-102](http://www.wago.com/216-102)



**Obj. č.: 216-103**  
Dutinka; Objímka na 1 mm<sup>2</sup> / AWG 18; Bez plastového límce; Galvanicky pocínováno

[www.wago.com/216-103](http://www.wago.com/216-103)











**Obj. č.: 216-104**  
Dutinka; Objímka na 1,5 mm<sup>2</sup> / AWG 16; Bez plastového límce; Galvanicky pocínováno

















[www.wago.com/216-104](http://www.wago.com/216-104)































**Obj. č.: 216-201**  
Ferrule; Sleeve for 0.5 mm<sup>2</sup> / 20 AWG; insulated; electro-tin plated; white

[www.wago.com/216-201](http://www.wago.com/216-201)







	<b>Obj. č.: 216-202</b> Ferrule; Sleeve for 0.75 mm <sup>2</sup> / 18 AWG; insulated; electro-tin plated; gray	<a href="http://www.wago.com/216-202">www.wago.com/216-202</a>
	<b>Obj. č.: 216-203</b> Dutinka; Objímka na 1 mm <sup>2</sup> / AWG 18; S plastovým límcem; Galvanicky pocínováno; Červená	<a href="http://www.wago.com/216-203">www.wago.com/216-203</a>
	<b>Obj. č.: 216-204</b> Dutinka; Objímka na 1,5 mm <sup>2</sup> / AWG 16; S plastovým límcem; Galvanicky pocínováno; Černá	<a href="http://www.wago.com/216-204">www.wago.com/216-204</a>
	<b>Obj. č.: 216-206</b> Dutinka; Objímka na 2,5 mm <sup>2</sup> / AWG 14; S plastovým límcem; Galvanicky pocínováno; Modrá	<a href="http://www.wago.com/216-206">www.wago.com/216-206</a>
	<b>Obj. č.: 216-301</b> Dutinka; Objímka na 0,25 mm <sup>2</sup> / AWG 24; S plastovým límcem; Galvanicky pocínováno; Žlutá	<a href="http://www.wago.com/216-301">www.wago.com/216-301</a>
	<b>Obj. č.: 216-302</b> Ferrule; Sleeve for 0.34 mm <sup>2</sup> / 22 AWG; insulated; electro-tin plated; green	<a href="http://www.wago.com/216-302">www.wago.com/216-302</a>
<b>Marking accessories</b>		
	<b>Obj. č.: 2009-145</b> Mini-WSB Inline; Pro Smart Printer; Na cívce; Flexibilní, 5–5,2 mm; Bez potisku; Možnost naklapnutí; Bílá	<a href="http://www.wago.com/2009-145">www.wago.com/2009-145</a>
	<b>Obj. č.: 2009-145/000-002</b> Mini-WSB Inline; Pro Smart Printer; Na cívce; Flexibilní, 5–5,2 mm; Bez potisku; Možnost naklapnutí; Žlutá	<a href="http://www.wago.com/2009-145/000-002">www.wago.com/2009-145/000-002</a>
	<b>Obj. č.: 2009-145/000-005</b> Mini-WSB Inline; Pro Smart Printer; Na cívce; Flexibilní, 5–5,2 mm; Bez potisku; Možnost naklapnutí; Červená	<a href="http://www.wago.com/2009-145/000-005">www.wago.com/2009-145/000-005</a>
	<b>Obj. č.: 2009-145/000-006</b> Mini-WSB Inline; Pro Smart Printer; Na cívce; Flexibilní, 5–5,2 mm; Bez potisku; Možnost naklapnutí; Modrá	<a href="http://www.wago.com/2009-145/000-006">www.wago.com/2009-145/000-006</a>
	<b>Obj. č.: 2009-145/000-007</b> Mini-WSB Inline; Pro Smart Printer; Na cívce; Flexibilní, 5–5,2 mm; Bez potisku; Možnost naklapnutí; Šedá	<a href="http://www.wago.com/2009-145/000-007">www.wago.com/2009-145/000-007</a>
	<b>Obj. č.: 2009-145/000-012</b> Mini-WSB Inline; Pro Smart Printer; Na cívce; Flexibilní, 5–5,2 mm; Bez potisku; Možnost naklapnutí; Oranžová	<a href="http://www.wago.com/2009-145/000-012">www.wago.com/2009-145/000-012</a>
	<b>Obj. č.: 2009-145/000-023</b> Mini-WSB Inline; Pro Smart Printer; Na cívce; Flexibilní, 5–5,2 mm; Bez potisku; Možnost naklapnutí; Zelená	<a href="http://www.wago.com/2009-145/000-023">www.wago.com/2009-145/000-023</a>
	<b>Obj. č.: 2009-145/000-024</b> Mini-WSB Inline; Pro Smart Printer; Na cívce; Flexibilní, 5–5,2 mm; Bez potisku; Možnost naklapnutí; Fialová	<a href="http://www.wago.com/2009-145/000-024">www.wago.com/2009-145/000-024</a>
	<b>Obj. č.: 248-501</b> Systém rychlého popisování Mini-WSB; Bez potisku; Šířka štítků 5 mm; 10 řad po 10 štítcích na každé kartě	<a href="http://www.wago.com/248-501">www.wago.com/248-501</a>
	<b>Obj. č.: 248-501/000-002</b> Popisovací karta Mini-WSB; Jako karta; Neflexibilní; Bez potisku; Možnost naklapnutí; Žlutá	<a href="http://www.wago.com/248-501/000-002">www.wago.com/248-501/000-002</a>

	<b>Obj. č.: 248-501/000-005</b> Popisovací karta Mini-WSB; Jako karta; Neflexibilní; Bez potisku; Možnost naklapnutí; Červená	<a href="http://www.wago.com/248-501/000-005">www.wago.com/248-501/000-005</a>
	<b>Obj. č.: 248-501/000-006</b> Popisovací karta Mini-WSB; Jako karta; Neflexibilní; Bez potisku; Možnost naklapnutí; Modrá	<a href="http://www.wago.com/248-501/000-006">www.wago.com/248-501/000-006</a>
	<b>Obj. č.: 248-501/000-007</b> Popisovací karta Mini-WSB; Jako karta; Neflexibilní; Bez potisku; Možnost naklapnutí; Šedá	<a href="http://www.wago.com/248-501/000-007">www.wago.com/248-501/000-007</a>
	<b>Obj. č.: 248-501/000-012</b> Popisovací karta Mini-WSB; Jako karta; Neflexibilní; Bez potisku; Možnost naklapnutí; Oranžová	<a href="http://www.wago.com/248-501/000-012">www.wago.com/248-501/000-012</a>
	<b>Obj. č.: 248-501/000-017</b> Popisovací karta Mini-WSB; Jako karta; Neflexibilní; Bez potisku; Možnost naklapnutí; Světle zelená	<a href="http://www.wago.com/248-501/000-017">www.wago.com/248-501/000-017</a>
	<b>Obj. č.: 248-501/000-023</b> Popisovací karta Mini-WSB; Jako karta; Neflexibilní; Bez potisku; Možnost naklapnutí; Zelená	<a href="http://www.wago.com/248-501/000-023">www.wago.com/248-501/000-023</a>
	<b>Obj. č.: 248-501/000-024</b> Popisovací karta Mini-WSB; Jako karta; Neflexibilní; Bez potisku; Možnost naklapnutí; Fialová	<a href="http://www.wago.com/248-501/000-024">www.wago.com/248-501/000-024</a>
<b>General accessories</b>		
	<b>Obj. č.: 280-404</b> Zkušební adaptér; Šířka 5 mm; Pro zkušební hrot 210-137 (Ø 2,3 mm); Vhodná pro svorky 1,5–4 mm <sup>2</sup> ; Šedá	<a href="http://www.wago.com/280-404">www.wago.com/280-404</a>
	<b>Obj. č.: 280-418</b> Modul pro zkušební zástrčku; Možnost řadového připojení; Vhodný ke všem řadovým svorkám WAGO řad 280 a 780 s drážkou pro můstek v napájecí liště; Šedá	<a href="http://www.wago.com/280-418">www.wago.com/280-418</a>
	<b>Obj. č.: 280-419</b> Slepý modul; Možnost řadového připojení; K přeskočení svorek; Šedá	<a href="http://www.wago.com/280-419">www.wago.com/280-419</a>
	<b>Obj. č.: 709-170</b> Blokovací pojistka proti zapojení; Pro rozpojovací vidlice rozpojovacích svorek řad 280/281 a 769; Červená	<a href="http://www.wago.com/709-170">www.wago.com/709-170</a>
	<b>Obj. č.: 769-438</b> Kryt kolíků; S držákem značení pro Mini-WSB; Šedá	<a href="http://www.wago.com/769-438">www.wago.com/769-438</a>
	<b>Obj. č.: 769-439</b> Kryt kolíků; S držákem značení pro Mini-WSB; Oranžová	<a href="http://www.wago.com/769-439">www.wago.com/769-439</a>
	<b>Obj. č.: 769-501</b> 1 vodičový počáteční modul s pružinovou svorkovnicí; S integrovanou koncovou bočnicí; 4 mm <sup>2</sup> ; 1pól.; 4,00 mm <sup>2</sup> ; Šedá	<a href="http://www.wago.com/769-501">www.wago.com/769-501</a>
	<b>Obj. č.: 769-501/000-006</b> 1 vodičový počáteční modul s pružinovou svorkovnicí; 4 mm <sup>2</sup> ; 1pól.; 4,00 mm <sup>2</sup> ; Modrá	<a href="http://www.wago.com/769-501/000-006">www.wago.com/769-501/000-006</a>
	<b>Obj. č.: 769-501/000-016</b> 1 vodičový počáteční modul s pružinovou svorkovnicí; S integrovanou koncovou bočnicí; 4 mm <sup>2</sup> ; 1pól.; 4,00 mm <sup>2</sup> ; Zeleno-žlutá	<a href="http://www.wago.com/769-501/000-016">www.wago.com/769-501/000-016</a>

	<b>Obj. č.: 769-502</b> 1 vodičový středový modul s pružinovou svorkovnicí; 4 mm <sup>2</sup> ; 1pól.; 4,00 mm <sup>2</sup> ; Šedá	<a href="http://www.wago.com/769-502">www.wago.com/769-502</a>
	<b>Obj. č.: 769-502/000-006</b> 1 vodičový středový modul s pružinovou svorkovnicí; 4 mm <sup>2</sup> ; 1pól.; 4,00 mm <sup>2</sup> ; Modrá	<a href="http://www.wago.com/769-502/000-006">www.wago.com/769-502/000-006</a>
	<b>Obj. č.: 769-502/000-016</b> 1 vodičový středový modul s pružinovou svorkovnicí; 4 mm <sup>2</sup> ; 1pól.; 4,00 mm <sup>2</sup> ; Zeleno-žlutá	<a href="http://www.wago.com/769-502/000-016">www.wago.com/769-502/000-016</a>
	<b>Obj. č.: 769-503</b> 1 vodičový koncový modul s pružinovou svorkovnicí; 4 mm <sup>2</sup> ; 1pól.; 4,00 mm <sup>2</sup> ; Šedá	<a href="http://www.wago.com/769-503">www.wago.com/769-503</a>
	<b>Obj. č.: 769-503/000-006</b> 1 vodičový koncový modul s pružinovou svorkovnicí; 4 mm <sup>2</sup> ; 1pól.; 4,00 mm <sup>2</sup> ; Modrá	<a href="http://www.wago.com/769-503/000-006">www.wago.com/769-503/000-006</a>
	<b>Obj. č.: 769-503/000-016</b> 1 vodičový koncový modul s pružinovou svorkovnicí; 4 mm <sup>2</sup> ; 1pól.; 4,00 mm <sup>2</sup> ; Zeleno-žlutá	<a href="http://www.wago.com/769-503/000-016">www.wago.com/769-503/000-016</a>
	<b>Obj. č.: 769-504</b> 2 vodičový počáteční modul s pružinovou svorkovnicí; S integrovanou koncovou bočnicí; 4 mm <sup>2</sup> ; 1pól.; 4,00 mm <sup>2</sup> ; Šedá	<a href="http://www.wago.com/769-504">www.wago.com/769-504</a>
	<b>Obj. č.: 769-504/000-006</b> 2 vodičový počáteční modul s pružinovou svorkovnicí; S integrovanou koncovou bočnicí; 4 mm <sup>2</sup> ; 1pól.; 4,00 mm <sup>2</sup> ; Modrá	<a href="http://www.wago.com/769-504/000-006">www.wago.com/769-504/000-006</a>
	<b>Obj. č.: 769-504/000-016</b> 2 vodičový počáteční modul s pružinovou svorkovnicí; 4 mm <sup>2</sup> ; 1pól.; 4,00 mm <sup>2</sup> ; Zeleno-žlutá	<a href="http://www.wago.com/769-504/000-016">www.wago.com/769-504/000-016</a>
	<b>Obj. č.: 769-505</b> 2 vodičový středový modul s pružinovou svorkovnicí; 4 mm <sup>2</sup> ; 1pól.; 4,00 mm <sup>2</sup> ; Šedá	<a href="http://www.wago.com/769-505">www.wago.com/769-505</a>
	<b>Obj. č.: 769-505/000-006</b> 2 vodičový středový modul s pružinovou svorkovnicí; 4 mm <sup>2</sup> ; 1pól.; 4,00 mm <sup>2</sup> ; Modrá	<a href="http://www.wago.com/769-505/000-006">www.wago.com/769-505/000-006</a>
	<b>Obj. č.: 769-505/000-016</b> 2 vodičový středový modul s pružinovou svorkovnicí; 4 mm <sup>2</sup> ; 1pól.; 4,00 mm <sup>2</sup> ; Zeleno-žlutá	<a href="http://www.wago.com/769-505/000-016">www.wago.com/769-505/000-016</a>
	<b>Obj. č.: 769-506</b> 2 vodičový koncový modul s pružinovou svorkovnicí; 4 mm <sup>2</sup> ; 1pól.; 4,00 mm <sup>2</sup> ; Šedá	<a href="http://www.wago.com/769-506">www.wago.com/769-506</a>
	<b>Obj. č.: 769-506/000-006</b> 2 vodičový koncový modul s pružinovou svorkovnicí; 4 mm <sup>2</sup> ; 1pól.; 4,00 mm <sup>2</sup> ; Modrá	<a href="http://www.wago.com/769-506/000-006">www.wago.com/769-506/000-006</a>
	<b>Obj. č.: 769-506/000-016</b> 2 vodičový koncový modul s pružinovou svorkovnicí; 4 mm <sup>2</sup> ; 1pól.; 4,00 mm <sup>2</sup> ; Zeleno-žlutá	<a href="http://www.wago.com/769-506/000-016">www.wago.com/769-506/000-016</a>
	<b>Obj. č.: 769-512</b> 1 vodičový počáteční modul s pružinovou svorkovnicí; Úhlové provedení; 4 mm <sup>2</sup> ; 1pól.; 4,00 mm <sup>2</sup> ; Šedá	<a href="http://www.wago.com/769-512">www.wago.com/769-512</a>

	<b>Obj. č.: 769-512/000-006</b> 1 vodičový počáteční modul s pružinovou svorkovnicí; Úhlové provedení; 4 mm <sup>2</sup> ; 1pól.; 4,00 mm <sup>2</sup> ; Modrá	<a href="http://www.wago.com/769-512/000-006">www.wago.com/769-512/000-006</a>
	<b>Obj. č.: 769-512/000-016</b> 1 vodičový počáteční modul s pružinovou svorkovnicí; Úhlové provedení; 4 mm <sup>2</sup> ; 1pól.; 4,00 mm <sup>2</sup> ; Zeleno-žlutá	<a href="http://www.wago.com/769-512/000-016">www.wago.com/769-512/000-016</a>
	<b>Obj. č.: 769-513</b> 1 vodičový středový modul s pružinovou svorkovnicí; Úhlové provedení; 4 mm <sup>2</sup> ; 1pól.; 4,00 mm <sup>2</sup> ; Šedá	<a href="http://www.wago.com/769-513">www.wago.com/769-513</a>
	<b>Obj. č.: 769-513/000-006</b> 1 vodičový středový modul s pružinovou svorkovnicí; Úhlové provedení; 4 mm <sup>2</sup> ; 1pól.; 4,00 mm <sup>2</sup> ; Modrá	<a href="http://www.wago.com/769-513/000-006">www.wago.com/769-513/000-006</a>
	<b>Obj. č.: 769-513/000-016</b> 1 vodičový středový modul s pružinovou svorkovnicí; Úhlové provedení; 4 mm <sup>2</sup> ; 1pól.; 4,00 mm <sup>2</sup> ; Zeleno-žlutá	<a href="http://www.wago.com/769-513/000-016">www.wago.com/769-513/000-016</a>
	<b>Obj. č.: 769-515</b> 1 vodičový koncový modul s pružinovou svorkovnicí; Úhlové provedení; 4 mm <sup>2</sup> ; 1pól.; 4,00 mm <sup>2</sup> ; Šedá	<a href="http://www.wago.com/769-515">www.wago.com/769-515</a>
	<b>Obj. č.: 769-515/000-006</b> 1 vodičový koncový modul s pružinovou svorkovnicí; Úhlové provedení; 4 mm <sup>2</sup> ; 1pól.; 4,00 mm <sup>2</sup> ; Modrá	<a href="http://www.wago.com/769-515/000-006">www.wago.com/769-515/000-006</a>
	<b>Obj. č.: 769-515/000-016</b> 1 vodičový koncový modul s pružinovou svorkovnicí; Úhlové provedení; 4 mm <sup>2</sup> ; 1pól.; 4,00 mm <sup>2</sup> ; Zeleno-žlutá	<a href="http://www.wago.com/769-515/000-016">www.wago.com/769-515/000-016</a>
<b>tools</b>		
	<b>Obj. č.: 210-720</b> Ovládací nástroj; Břit: 3,5 × 0,5 mm; S částečně izolovanou rukojetí	<a href="http://www.wago.com/210-720">www.wago.com/210-720</a>
<b>Carrier rail</b>		
	<b>Obj. č.: 210-112</b> Ocelová nosná lišta; 35 × 7,5 mm; Tloušťka 1 mm; Délka 2 m; Děrovaná; Dle normy EN 60715; Šířka otvorů 25 mm; vzdálenost mezi otvory 36 mm	<a href="http://www.wago.com/210-112">www.wago.com/210-112</a>
	<b>Obj. č.: 210-113</b> Ocelová nosná lišta; 35 × 7,5 mm; Tloušťka 1 mm; Délka 2 m; Neděrovaná; Dle normy EN 60715	<a href="http://www.wago.com/210-113">www.wago.com/210-113</a>
	<b>Obj. č.: 210-114</b> Ocelová nosná lišta; 35 × 15 mm; Tloušťka 1,5 mm; Délka 2 m; Neděrovaná; Podobné EN 60715	<a href="http://www.wago.com/210-114">www.wago.com/210-114</a>
	<b>Obj. č.: 210-115</b> Ocelová nosná lišta; 35 × 7,5 mm; Tloušťka 1 mm; Délka 2 m; Děrovaná; Dle normy EN 60715; Šířka otvorů 18 mm; vzdálenost mezi otvory 25 mm	<a href="http://www.wago.com/210-115">www.wago.com/210-115</a>
	<b>Obj. č.: 210-118</b> Ocelová nosná lišta; 35 × 15 mm; Tloušťka 2,3 mm; Délka 2 m; Neděrovaná; Dle normy EN 60715	<a href="http://www.wago.com/210-118">www.wago.com/210-118</a>
	<b>Obj. č.: 210-196</b> Hliníková nosná lišta; 35 × 8,2 mm; Tloušťka 1,6 mm; Délka 2 m; Neděrovaná; Podobné EN 60715; Stříbrná	<a href="http://www.wago.com/210-196">www.wago.com/210-196</a>
	<b>Obj. č.: 210-197</b> Ocelová nosná lišta; 35 × 15 mm; Tloušťka 1,5 mm; Délka 2 m; Děrovaná; Podobné EN 60715	<a href="http://www.wago.com/210-197">www.wago.com/210-197</a>
	<b>Obj. č.: 210-198</b>	



	Měděná nosná lišta; 35 × 15 mm; Tloušťka 2,3 mm; Délka 2 m; Neděrovaná; Dle normy EN 60715; Měděná	<a href="http://www.wago.com/210-198">www.wago.com/210-198</a>
	<b>Obj. č.: 210-504</b> Ocelová nosná lišta; 35 × 7,5 mm; Tloušťka 1 mm; Délka 2 m; Děrovaná; Pásově zinkováno; Dle normy EN 60715	<a href="http://www.wago.com/210-504">www.wago.com/210-504</a>
	<b>Obj. č.: 210-505</b> Ocelová nosná lišta; 35 × 7,5 mm; Tloušťka 1 mm; Délka 2 m; Neděrovaná; Pásově zinkováno; Dle normy EN 60715	<a href="http://www.wago.com/210-505">www.wago.com/210-505</a>
	<b>Obj. č.: 210-506</b> Ocelová nosná lišta; 35 × 15 mm; Tloušťka 1,5 mm; Délka 2 m; Neděrovaná; Pásově zinkováno; Podobné EN 60715	<a href="http://www.wago.com/210-506">www.wago.com/210-506</a>
	<b>Obj. č.: 210-508</b> Ocelová nosná lišta; 35 × 15 mm; Tloušťka 1,5 mm; Délka 2 m; Děrovaná; Pásově zinkováno; Podobné EN 60715	<a href="http://www.wago.com/210-508">www.wago.com/210-508</a>
<b>Coding</b>		
	<b>Obj. č.: 769-435</b> Kódovací kolík; Ke kódování pružinových svorkovnic; Pro základní svorky / konektory s pájecími piny; Oranžová	<a href="http://www.wago.com/769-435">www.wago.com/769-435</a>
<b>Protective Warning Marker</b>		
	<b>Obj. č.: 280-415</b> Výstražný kryt; S černým symbolem blesku; Pro 5 svorek; Žlutá	<a href="http://www.wago.com/280-415">www.wago.com/280-415</a>

## Ke stažení

### Documentation

#### Additional Information

Technical explanations	03-Apr-2019	pdf 2,1 MB	Stáhnout
------------------------	-------------	---------------	----------

### CAD/CAE-Data

#### CAD data

2D/3D Models 769-213	URL	Stáhnout
----------------------	-----	----------

#### CAE data

EPLAN Data Portal 769-213	Stáhnout
---------------------------	----------

WSCAD Universe 769-213	Stáhnout
------------------------	----------

### Handling Instructions

#### Assembly

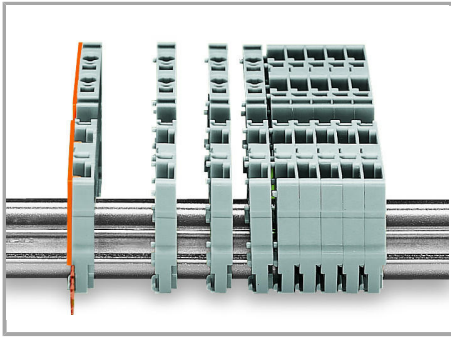

Snap individual carrier terminal blocks onto the carrier rail and slide together.

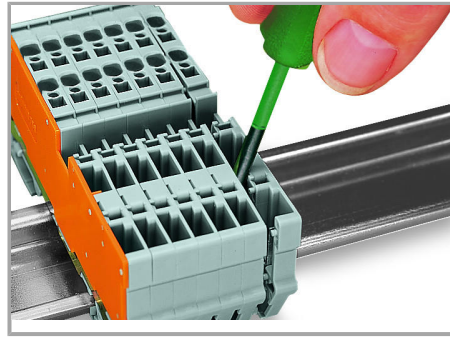

Open the assembly by laterally sliding a block via operating tool and remove terminal block via release lever.

#### Inserting a conductor

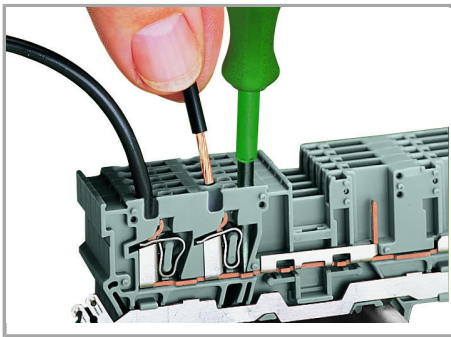

CAGE CLAMP® connection

Carrier terminal block: Insert/remove conductor via operating tool (3.5 x 0.5 mm blade).

Jumpered

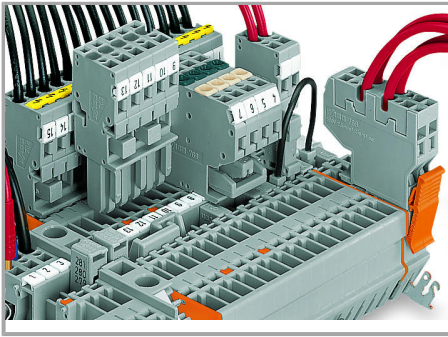

Commoning with adjacent or staggered jumpers –

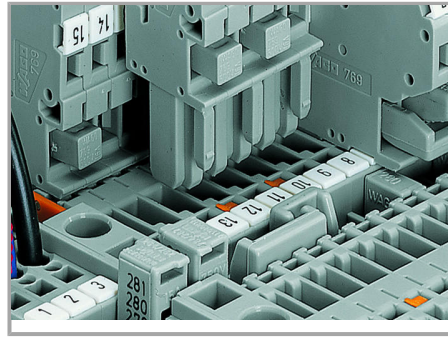

Commoning carrier terminal blocks via staggered jumpers.

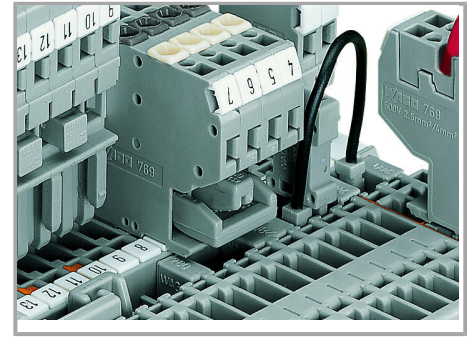

Commoning a 2-conductor female plug via staggered jumper and carrier terminal blocks via adjacent jumpers.

push jumpers down until fully inserted.

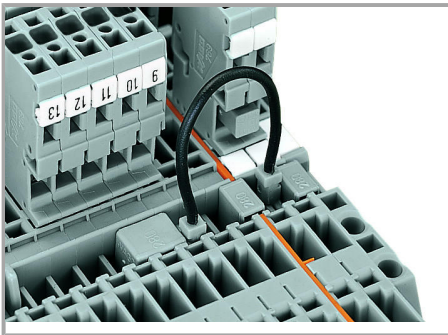

Commoning carrier terminal blocks via push-in type wire jumpers or adjacent jumpers – even over an intermediate plate.

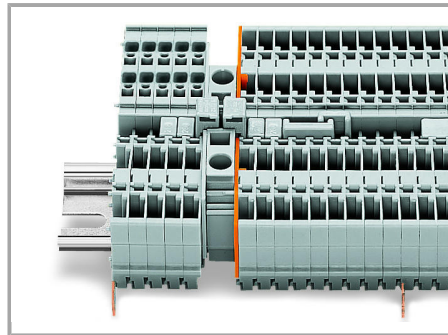

Commoning “supply terminal blocks” (up to 10 mm<sup>2</sup>/8 AWG) with carrier terminal blocks via step-down jumpers.

### Testing

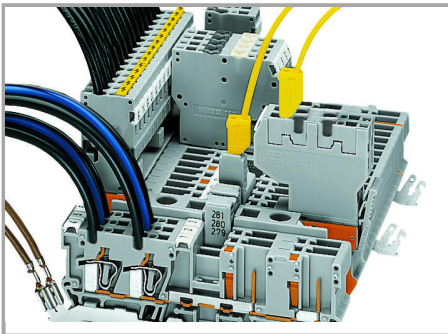

Testing via 2 or 2.3 mm Ø test plugs.

### Coding

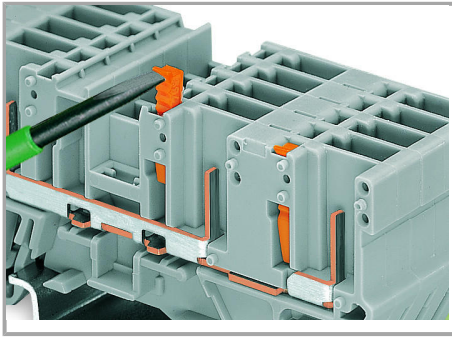

Snap coding pin in proper direction on carrier terminal block.

Shown: Coding pin removal from carrier terminal block.

#### Locking

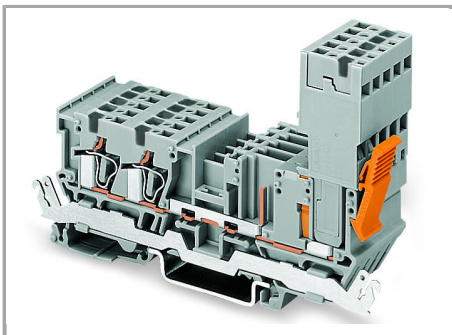

Female plug secured with locking lever on the terminal block side.

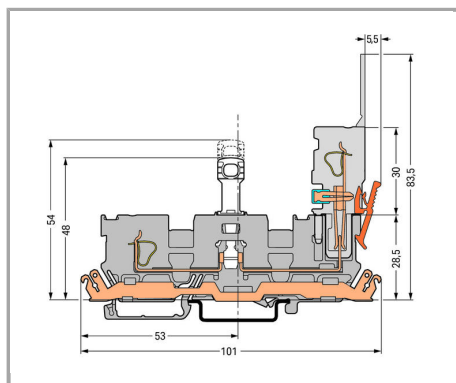

Disconnect carrier terminal block with shield contact

For other dimensions, see 769-171 Carrier Terminal Block.

### Safety

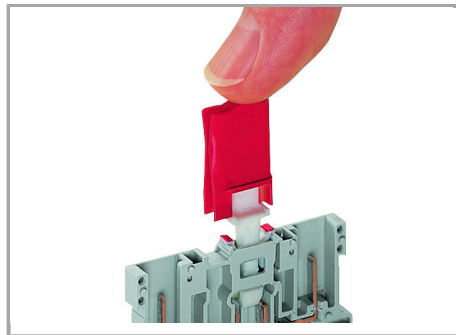

Installing a disconnect lock on the terminal block's disconnect tab.

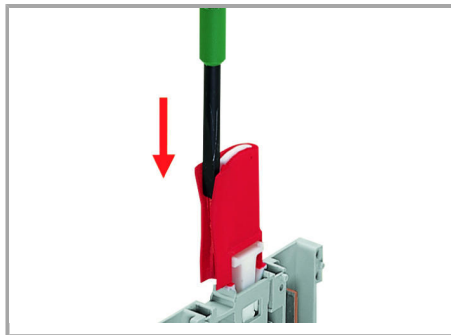

Unlocking a disconnect lock.

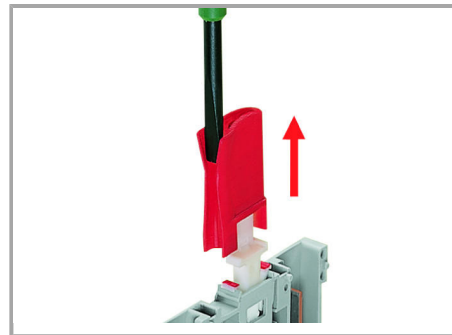

Removing a disconnect lock.

### Produktová rodina

#### X-COM

[Zobrazit všechny produkty z rodiny](#)

Změny vyhrazeny.