

## Datový list | Objednáací číslo: 280-901

2vodičová průchozí svorka; 2,5 mm<sup>2</sup>; Středový popis; Na DIN lištu 35 × 15  
a 35 × 7,5; CAGE CLAMP®; 2,50 mm<sup>2</sup>; Šedá

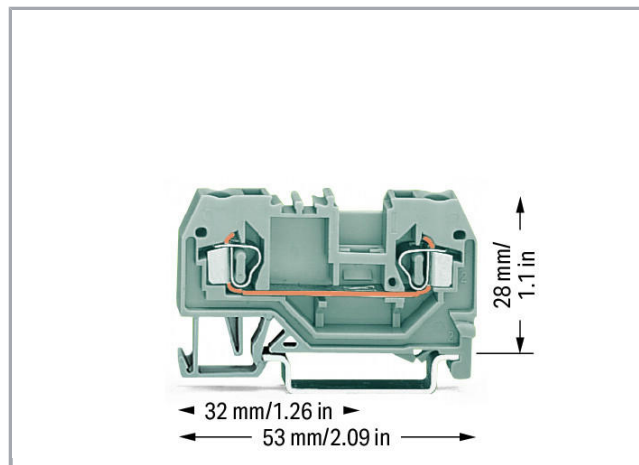

[www.wago.com/280-901](http://www.wago.com/280-901)

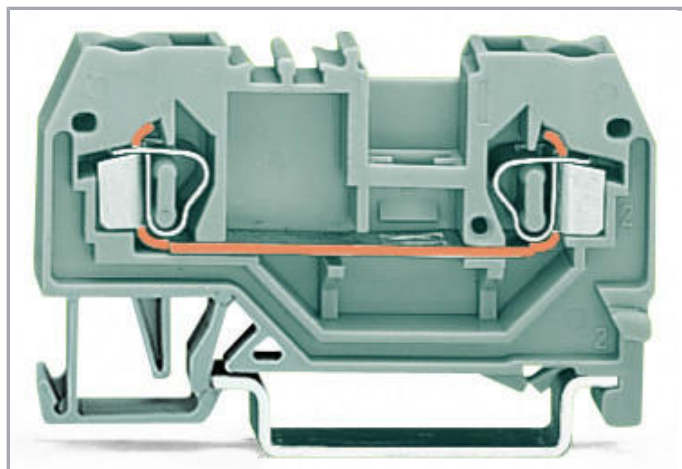

RoHS    
Compliant

BOMcheck.net

Barva: ■

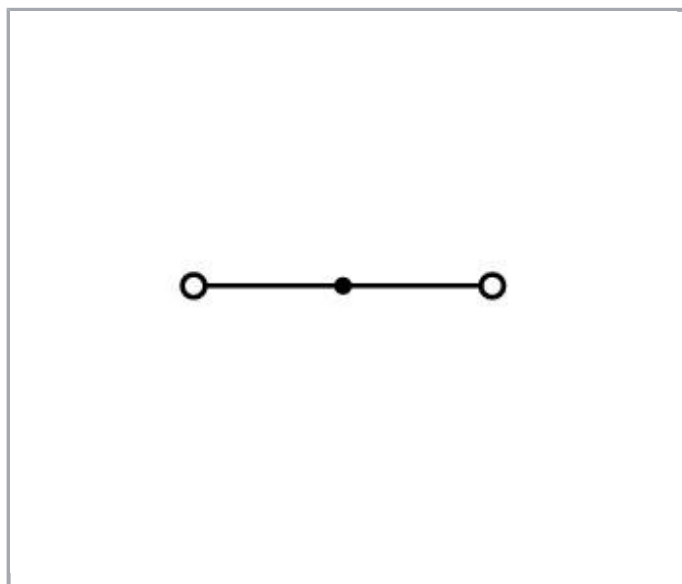

### Popis položky

#### Upozornění:

#### Terminating Aluminum Conductors

WAGO spring clamp terminal blocks are suitable for solid aluminum conductors up to 4 mm<sup>2</sup>/12 AWG if WAGO "Alu-Plus" Contact Paste is used for termination.



"Alu-Plus" Contact Paste Advantages:

- Automatically destroys the oxide film during clamping.
- Prevents fresh oxidation at the clamping point.
- Prevents electrolytic corrosion between aluminum and copper conductors (in the same terminal block).
- Provides long-term protection against corrosion.

Using terminal blocks with CAGE CLAMP® Spring Pressure Connection Technology, aluminum conductors must first be cleaned with a blade and then immediately be inserted into the clamping units filled with "Alu-Plus" Contact Paste.

It is also possible to apply WAGO "Alu-Plus" **additionally** on the whole surface of the aluminum conductor before termination.

Please note that the nominal currents must be adapted to the reduced conductivity of the aluminum conductors:

2.5 mm<sup>2</sup> (14 AWG) = 16 A

4 mm<sup>2</sup> (12 AWG) = 22 A

## Data

### Elektrické parametry

#### Ratings per IEC/EN 60664-1

Návrhové napětí (III / 3)	800 V
Návrhové rázové napětí (III / 3)	8 kV
Jmenovitý proud	24 A
Legenda (návrhové hodnoty)	(III / 3) ≙ kategorie přepětí III / stupeň znečištění 3

### Údaje o připojení

Připojovací technika	CAGE CLAMP®
Způsob ovládání	Ovládací nástroj
Materiály připojitelných vodičů	Měď Hliník
Plný vodič	0,08 ... 2,5 mm <sup>2</sup> / 28 ... 12 AWG
Jemně laněný vodič	0,08 ... 2,5 mm <sup>2</sup> / 28 ... 12 AWG
Délka odizolování	8 ... 9 mm / 0.31 ... 0.35 palec
Celkový počet kontaktních míst	2
Celkový počet potenciálů	1
Počet úrovní	1
Způsob zapojení	čelní připojení
Upozornění (průřez vodiče)	12 AWG: THHN, THWN

### Geometrické údaje

Šířka	5 mm / 0.197 inch
-------	-------------------

Výška od horní hrany lišty DIN 35	28 mm / 1.102 inch
Hloubka	53 mm / 2.087 inch

### Mechanické parametry

Provedení	Horizontální provedení
Způsob montáže	Lišta DIN 35
Úroveň popisování	Středový popis

### Údaje o materiálu



barva	Šedá
Izolační materiál	Polyamid 66 (PA 66)
Požární zatížení	0.106 MJ
Hmotnost	5.3 g

### Obchodní údaje

Product Group	1 (Rail Mounted Terminal Blocks)
Druh balení	BOX
Country of origin	DE
GTIN	4044918391726
Customs Tariff No.	85369010000

### Atesty/certifikáty

#### Specifické atesty jednotlivých států

Logo	Schválení	Doplňkový text schválení	Název certifikátu
	CCA DEKRA Certification B.V.	EN 60947	2157201.01
	CSA DEKRA Certification B.V.	C22.2	1536071

#### Atesty pro použití v lodním průmyslu

Logo	Schválení	Doplňkový text schválení	Název certifikátu
	ABS American Bureau of Shipping	EN 60947	14- HG1293677- PDA
	BV Bureau Veritas S.A.	EN 60947	07436/E0 BV



BUREAU  
VERITAS

**DNV GL**

Det Norske Veritas, Germanischer Lloyd

-

TAE00001V2



**LR**

Lloyds Register

EN 60947

91/20112  
(E9)



#### Atesty UL

Logo	Schválení	Doplňkový text schválení	Název certifikátu
	UL Underwriters Laboratories Inc.	UL 1059	20170731- E45172

#### Kompatibilní produkty

##### Jumper



**Obj. č.: 210-103**

Vícenásobný vodičový můstek; Izolováno; 50 přípojek; Černá

[www.wago.com/210-103](http://www.wago.com/210-103)



**Obj. č.: 210-123**

Vícenásobný vodičový můstek; Izolováno; 50 přípojek

[www.wago.com/210-123](http://www.wago.com/210-123)



**Obj. č.: 249-123**

Vodičový můstek; Izolováno; L = 180 mm; Průřez vedení 0,75 mm<sup>2</sup>

[www.wago.com/249-123](http://www.wago.com/249-123)



**Obj. č.: 249-125**

Vodičový můstek; Izolováno; L = 60 mm; Průřez vedení 0,75 mm<sup>2</sup>

[www.wago.com/249-125](http://www.wago.com/249-125)





















**Obj. č.: 249-126**

Vodičový můstek; Izolováno; L = 110 mm; Průřez vedení 0,75 mm<sup>2</sup>

[www.wago.com/249-126](http://www.wago.com/249-126)

**Obj. č.: 249-127**

	Vodičový můstek; Izolováno; L = 250 mm; Průřez vedení 0,75 mm <sup>2</sup>	<a href="http://www.wago.com/249-127">www.wago.com/249-127</a>
	<b>Obj. č.: 280-402</b> Příčný můstek; Izolováno; IN = IN svorky; Šedá	<a href="http://www.wago.com/280-402">www.wago.com/280-402</a>
	<b>Obj. č.: 280-409</b> Příčný můstek ob svorku; Izolováno; IN = IN svorky; Šedá	<a href="http://www.wago.com/280-409">www.wago.com/280-409</a>
	<b>Obj. č.: 280-422</b> Příčný můstek; Izolováno; IN = IN svorky; Žlutozelená	<a href="http://www.wago.com/280-422">www.wago.com/280-422</a>
	<b>Obj. č.: 280-482</b> Hřebenový můstek; Izolováno; 2x; IN = IN svorky; Šedá	<a href="http://www.wago.com/280-482">www.wago.com/280-482</a>
	<b>Obj. č.: 280-483</b> Hřebenový můstek; Izolováno; 3x; IN = IN svorky; Šedá	<a href="http://www.wago.com/280-483">www.wago.com/280-483</a>
	<b>Obj. č.: 280-484</b> Hřebenový můstek; Izolováno; 4x; IN = IN svorky; Šedá	<a href="http://www.wago.com/280-484">www.wago.com/280-484</a>
	<b>Obj. č.: 280-485</b> Hřebenový můstek; Izolováno; 5x; IN = IN svorky; Šedá	<a href="http://www.wago.com/280-485">www.wago.com/280-485</a>
	<b>Obj. č.: 280-490</b> Hřebenový můstek; Izolováno; 10x; IN = IN svorky; Šedá	<a href="http://www.wago.com/280-490">www.wago.com/280-490</a>
	<b>Obj. č.: 280-492</b> Hřebenový můstek ob svorku; Izolováno; 2x; IN = IN svorky; Šedá	<a href="http://www.wago.com/280-492">www.wago.com/280-492</a>
	<b>Obj. č.: 284-414</b> Redukční můstek; Izolováno; Z 10/6 mm <sup>2</sup> na 4/2,5/1,5 mm <sup>2</sup> ; Jmenovitý proud 15 A; Šedá	<a href="http://www.wago.com/284-414">www.wago.com/284-414</a>
	<b>Obj. č.: 709-110</b> Vícenásobný vodičový můstek; Izolováno; 4 přípojky; 3 × 110 mm; Černá	<a href="http://www.wago.com/709-110">www.wago.com/709-110</a>
	<b>Obj. č.: 709-111</b> Vícenásobný vodičový můstek; Izolováno; 3 přípojek; 2 × 120 mm; Černá	<a href="http://www.wago.com/709-111">www.wago.com/709-111</a>
	<b>Obj. č.: 709-112</b> Vícenásobný vodičový můstek; Izolováno; 3 přípojek; 2 × 170 mm; Černá	<a href="http://www.wago.com/709-112">www.wago.com/709-112</a>
	<b>Obj. č.: 780-452</b> Stupňovitý můstek; Izolováno; Z 1 na 2; Rozteč 5 mm; Vhodný pro 2vodičové pružinové svorkovnice; Šedá	<a href="http://www.wago.com/780-452">www.wago.com/780-452</a>
	<b>Obj. č.: 780-453</b> Stupňovitý můstek; Izolováno; z 1 na 3; Rozteč 5 mm; Vhodný pro 2vodičové pružinové svorkovnice; Šedá	<a href="http://www.wago.com/780-453">www.wago.com/780-453</a>
	<b>Obj. č.: 780-454</b> Stupňovitý můstek; Izolováno; Z 1 na 4; Rozteč 5 mm; Vhodný pro 2vodičové pružinové svorkovnice; Šedá	<a href="http://www.wago.com/780-454">www.wago.com/780-454</a>
	<b>Obj. č.: 780-455</b> Stupňovitý můstek; Izolováno; Z 1 na 5; Rozteč 5 mm; Vhodný pro 2vodičové pružinové svorkovnice; Šedá	<a href="http://www.wago.com/780-455">www.wago.com/780-455</a>
	<b>Obj. č.: 780-456</b> Stupňovitý můstek; Izolováno; Z 1 na 6; Rozteč 5 mm; Vhodný pro 2vodičové pružinové svorkovnice; Šedá	<a href="http://www.wago.com/780-456">www.wago.com/780-456</a>
	<b>Obj. č.: 780-457</b>	



Stupňovitý můstek; Izolováno; Z 1 na 7; Rozteč 5 mm; Vhodný pro 2vodičové pružinové svorkovnice; Šedá [www.wago.com/780-457](http://www.wago.com/780-457)



**Obj. č.: 780-458**  
Stupňovitý můstek; Izolováno; Z 1 na 8; Rozteč 5 mm; Vhodný pro 2vodičové pružinové svorkovnice; Šedá [www.wago.com/780-458](http://www.wago.com/780-458)

#### Marking accessories



**Obj. č.: 2009-115**  
WMB Inline; Pro Smart Printer; Na cívce; Flexibilní, 5–5,2 mm; Bez potisku; Možnost naklapnutí; Bílá [www.wago.com/2009-115](http://www.wago.com/2009-115)



**Obj. č.: 2009-115/000-002**  
WMB Inline; Pro Smart Printer; Na cívce; Flexibilní, 5–5,2 mm; Bez potisku; Možnost naklapnutí; Žlutá [www.wago.com/2009-115/000-002](http://www.wago.com/2009-115/000-002)



**Obj. č.: 2009-115/000-006**  
WMB Inline; Pro Smart Printer; Na cívce; Flexibilní, 5–5,2 mm; Bez potisku; Možnost naklapnutí; Modrá [www.wago.com/2009-115/000-006](http://www.wago.com/2009-115/000-006)



**Obj. č.: 2009-115/000-007**  
WMB Inline; Pro Smart Printer; Na cívce; Flexibilní, 5–5,2 mm; Bez potisku; Možnost naklapnutí; Šedá [www.wago.com/2009-115/000-007](http://www.wago.com/2009-115/000-007)



**Obj. č.: 2009-115/000-012**  
WMB Inline; Pro Smart Printer; Na cívce; Flexibilní, 5–5,2 mm; Bez potisku; Možnost naklapnutí; Oranžová [www.wago.com/2009-115/000-012](http://www.wago.com/2009-115/000-012)



**Obj. č.: 2009-115/000-017**  
WMB Inline; Pro Smart Printer; Na cívce; Flexibilní, 5–5,2 mm; Bez potisku; Možnost naklapnutí; Světle zelená [www.wago.com/2009-115/000-017](http://www.wago.com/2009-115/000-017)



**Obj. č.: 2009-115/000-023**  
WMB Inline; Pro Smart Printer; Na cívce; Flexibilní, 5–5,2 mm; Bez potisku; Možnost naklapnutí; Zelená [www.wago.com/2009-115/000-023](http://www.wago.com/2009-115/000-023)



**Obj. č.: 2009-115/000-024**  
WMB Inline; Pro Smart Printer; Na cívce; Flexibilní, 5–5,2 mm; Bez potisku; Možnost naklapnutí; Fialová [www.wago.com/2009-115/000-024](http://www.wago.com/2009-115/000-024)



**Obj. č.: 209-128**  
Adaptér [www.wago.com/209-128](http://www.wago.com/209-128)



**Obj. č.: 209-140**  
Nosič skupinového označení [www.wago.com/209-140](http://www.wago.com/209-140)



**Obj. č.: 209-141**  
Nosič skupinového označení [www.wago.com/209-141](http://www.wago.com/209-141)



**Obj. č.: 209-142**  
Nosič skupinového označení [www.wago.com/209-142](http://www.wago.com/209-142)



**Obj. č.: 209-185**  
Adaptér [www.wago.com/209-185](http://www.wago.com/209-185)



**Obj. č.: 210-612**  
Popisovací páska; K vlastnímu popisování; Bez potisku; Samolepicí; Transparentní [www.wago.com/210-612](http://www.wago.com/210-612)



**Obj. č.: 793-501**  
Popisovací karta WMB; Jako karta; Neflexibilní; Bez potisku; Možnost naklapnutí; Bílá [www.wago.com/793-501](http://www.wago.com/793-501)

**Obj. č.: 793-501/000-002**

Popisovací karta WMB; Jako karta; Neflexibilní; Bez potisku; Možnost naklapnutí; Bílá

[www.wago.com/793-501/000-002](http://www.wago.com/793-501/000-002)**Obj. č.: 793-501/000-005**

Popisovací karta WMB; Jako karta; Neflexibilní; Bez potisku; Možnost naklapnutí; Červená

[www.wago.com/793-501/000-005](http://www.wago.com/793-501/000-005)**Obj. č.: 793-501/000-006**

Popisovací karta WMB; Jako karta; Neflexibilní; Bez potisku; Možnost naklapnutí; Modrá

[www.wago.com/793-501/000-006](http://www.wago.com/793-501/000-006)**Obj. č.: 793-501/000-007**

Popisovací karta WMB; Jako karta; Neflexibilní; Bez potisku; Možnost naklapnutí; Šedá

[www.wago.com/793-501/000-007](http://www.wago.com/793-501/000-007)**Obj. č.: 793-501/000-012**

Popisovací karta WMB; Jako karta; Neflexibilní; Bez potisku; Možnost naklapnutí; Oranžová

[www.wago.com/793-501/000-012](http://www.wago.com/793-501/000-012)**Obj. č.: 793-501/000-017**

Popisovací karta WMB; Jako karta; Neflexibilní; Bez potisku; Možnost naklapnutí; Světle zelená

[www.wago.com/793-501/000-017](http://www.wago.com/793-501/000-017)**Obj. č.: 793-501/000-023**

Popisovací karta WMB; Jako karta; Neflexibilní; Bez potisku; Možnost naklapnutí; Zelená

[www.wago.com/793-501/000-023](http://www.wago.com/793-501/000-023)**Obj. č.: 793-501/000-024**

Popisovací karta WMB; Jako karta; Neflexibilní; Bez potisku; Možnost naklapnutí; Fialová

[www.wago.com/793-501/000-024](http://www.wago.com/793-501/000-024)**Obj. č.: 793-5501**

Popisovací karta WMB; Jako karta; Pro svorky o šířce 5–17,5 mm; Flexibilní, 5–5,2 mm; Bez potisku; Možnost naklapnutí; Bílá

[www.wago.com/793-5501](http://www.wago.com/793-5501)**Obj. č.: 793-5501/000-002**

Popisovací karta WMB; Jako karta; Pro svorky o šířce 5–17,5 mm; Flexibilní, 5–5,2 mm; Bez potisku; Možnost naklapnutí; Žlutá

[www.wago.com/793-5501/000-002](http://www.wago.com/793-5501/000-002)**Obj. č.: 793-5501/000-005**

Popisovací karta WMB; Jako karta; Flexibilní, 5–5,2 mm; Bez potisku; Možnost naklapnutí; Červená

[www.wago.com/793-5501/000-005](http://www.wago.com/793-5501/000-005)**Obj. č.: 793-5501/000-006**

Popisovací karta WMB; Jako karta; Flexibilní, 5–5,2 mm; Bez potisku; Možnost naklapnutí; Modrá

[www.wago.com/793-5501/000-006](http://www.wago.com/793-5501/000-006)**Obj. č.: 793-5501/000-007**

Popisovací karta WMB; Jako karta; Flexibilní, 5–5,2 mm; Bez potisku; Možnost naklapnutí; Šedá

[www.wago.com/793-5501/000-007](http://www.wago.com/793-5501/000-007)**Obj. č.: 793-5501/000-012**

Popisovací karta WMB; Jako karta; Flexibilní, 5–5,2 mm; Bez potisku; Možnost naklapnutí; Oranžová

[www.wago.com/793-5501/000-012](http://www.wago.com/793-5501/000-012)**Obj. č.: 793-5501/000-017**

Popisovací karta WMB; Jako karta; Flexibilní, 5–5,2 mm; Bez potisku; Možnost naklapnutí; Světle zelená

[www.wago.com/793-5501/000-017](http://www.wago.com/793-5501/000-017)



Obj. č.: 793-5501/000-023

Popisovací karta WMB; Jako karta; Flexibilní, 5–5,2 mm; Bez potisku; Možnost naklapnutí; Zelená

[www.wago.com/793-5501/000-023](http://www.wago.com/793-5501/000-023)



Obj. č.: 793-5501/000-024

Popisovací karta WMB; Jako karta; Flexibilní, 5–5,2 mm; Bez potisku; Možnost naklapnutí; Fialová

[www.wago.com/793-5501/000-024](http://www.wago.com/793-5501/000-024)

#### ferrule



Obj. č.: 216-101

Dutinka; Objímka na 0,5 mm<sup>2</sup> / AWG 22; Bez plastového límce; Galvanicky pocínováno

[www.wago.com/216-101](http://www.wago.com/216-101)



Obj. č.: 216-102

Dutinka; Objímka na 0,75 mm<sup>2</sup> / AWG 20; Bez plastového límce; Galvanicky pocínováno

[www.wago.com/216-102](http://www.wago.com/216-102)



Obj. č.: 216-103

Dutinka; Objímka na 1 mm<sup>2</sup> / AWG 18; Bez plastového límce; Galvanicky pocínováno

[www.wago.com/216-103](http://www.wago.com/216-103)



Obj. č.: 216-104

Dutinka; Objímka na 1,5 mm<sup>2</sup> / AWG 16; Bez plastového límce; Galvanicky pocínováno

[www.wago.com/216-104](http://www.wago.com/216-104)



Obj. č.: 216-201

Ferrule; Sleeve for 0.5 mm<sup>2</sup> / 20 AWG; insulated; electro-tin plated; white

[www.wago.com/216-201](http://www.wago.com/216-201)



Obj. č.: 216-202

Ferrule; Sleeve for 0.75 mm<sup>2</sup> / 18 AWG; insulated; electro-tin plated; gray

[www.wago.com/216-202](http://www.wago.com/216-202)



Obj. č.: 216-203

Dutinka; Objímka na 1 mm<sup>2</sup> / AWG 18; S plastovým límcem; Galvanicky pocínováno; Červená

[www.wago.com/216-203](http://www.wago.com/216-203)



Obj. č.: 216-204

Dutinka; Objímka na 1,5 mm<sup>2</sup> / AWG 16; S plastovým límcem; Galvanicky pocínováno; Černá

[www.wago.com/216-204](http://www.wago.com/216-204)

Obj. č.: 216-301

Dutinka; Objímka na 0,25 mm<sup>2</sup> / AWG 24; S plastovým límcem; Galvanicky pocínováno; Žlutá

[www.wago.com/216-301](http://www.wago.com/216-301)



Obj. č.: 216-302

Ferrule; Sleeve for 0.34 mm<sup>2</sup> / 22 AWG; insulated; electro-tin plated; green

[www.wago.com/216-302](http://www.wago.com/216-302)

#### Protective Warning Marker



Obj. č.: 280-415

Výstražný kryt; S černým symbolem blesku; Pro 5 svorek; Žlutá

[www.wago.com/280-415](http://www.wago.com/280-415)

#### End plate



Obj. č.: 280-308

Koncová bočnice a separátor; Tloušťka 2,5 mm; Šedá

[www.wago.com/280-308](http://www.wago.com/280-308)



Obj. č.: 280-309

Koncová bočnice a separátor; Tloušťka 2,5 mm; Oranžová

[www.wago.com/280-309](http://www.wago.com/280-309)



Obj. č.: 280-310

Přepážka; Tloušťka 2 mm; S přesahem; Šedá

[www.wago.com/280-310](http://www.wago.com/280-310)



Obj. č.: 280-311

Přepážka; Tloušťka 2 mm; S přesahem; Oranžová

[www.wago.com/280-311](http://www.wago.com/280-311)



Obj. č.: 284-334

Redukční kryt; Tloušťka 1 mm; Ve spojení s 2-, 3- a 4vodičovými svorkami; Šedá

[www.wago.com/284-334](http://www.wago.com/284-334)





**Obj. č.: 284-344**  
 Redukční kryt; Tloušťka 1 mm; Ve spojení s 2-, 3- a 4vodičovými svorkami; Oranžová

[www.wago.com/284-344](http://www.wago.com/284-344)

check



**Obj. č.: 209-170**  
 Zkušební adaptér; Šířka 8,3 mm; Pro zkušební hrot o průměru 4 mm; Vhodná pro svorky 1,5–10 mm<sup>2</sup>; Šedá [www.wago.com/209-170](http://www.wago.com/209-170)



**Obj. č.: 249-106**  
 Modul pro zkušební zástrčku B; Možnost řadového připojení; 1,50 mm<sup>2</sup>; Šedá [www.wago.com/249-106](http://www.wago.com/249-106)



**Obj. č.: 249-107**  
 Slepý modul B; Možnost řadového připojení; K přeskočení např. propojených svorek; Šedá [www.wago.com/249-107](http://www.wago.com/249-107)



**Obj. č.: 249-141**  
 Modul pro zkušební zástrčku L; Možnost řadového připojení; S pružnou kontaktní vidlicí; Středový modul; 1,50 mm<sup>2</sup>; Šedá [www.wago.com/249-141](http://www.wago.com/249-141)



**Obj. č.: 249-142**  
 Aretační zkušební modul L; Možnost řadového připojení; S pevnou kontaktní vidlicí; Vnější modul; 1,50 mm<sup>2</sup>; Šedá [www.wago.com/249-142](http://www.wago.com/249-142)



**Obj. č.: 249-143**  
 Slepý modul L; Možnost řadového připojení; K přeskočení například zapojených svorek; Šedá [www.wago.com/249-143](http://www.wago.com/249-143)

assembling



**Obj. č.: 209-106**  
 Držák; K izolované montáži nosných lišt DIN 35; Šedá [www.wago.com/209-106](http://www.wago.com/209-106)



**Obj. č.: 210-148**  
 Úchytka pro šikmou montáž; Bez šroubu [www.wago.com/210-148](http://www.wago.com/210-148)



**Obj. č.: 709-153**  
 Krycí profil; Typ 1; Vhodný pro držák krycího profilu typu 1; Délka 1 m; Transparentní [www.wago.com/709-153](http://www.wago.com/709-153)

tools



**Obj. č.: 210-657**  
 Ovládací nástroj; Břit: 3,5 × 0,5 mm; S částečně izolovanou rukojetí; Krátké [www.wago.com/210-657](http://www.wago.com/210-657)



**Obj. č.: 210-658**  
 Ovládací nástroj; Břit: 3,5 × 0,5 mm; S částečně izolovanou rukojetí; Úhlové provedení; Krátké [www.wago.com/210-658](http://www.wago.com/210-658)



**Obj. č.: 210-720**  
 Ovládací nástroj; Břit: 3,5 × 0,5 mm; S částečně izolovanou rukojetí [www.wago.com/210-720](http://www.wago.com/210-720)

Carrier rail



**Obj. č.: 210-112**  
 Ocelová nosná lišta; 35 × 7,5 mm; Tloušťka 1 mm; Délka 2 m; Děrovaná; Dle normy EN 60715; Šířka otvorů 25 mm; vzdálenost mezi otvory 36 mm [www.wago.com/210-112](http://www.wago.com/210-112)

















**Obj. č.: 210-113**  
 Ocelová nosná lišta; 35 × 7,5 mm; Tloušťka 1 mm; Délka 2 m; Neděrovaná; Dle normy EN 60715 [www.wago.com/210-113](http://www.wago.com/210-113)































**Obj. č.: 210-114**  
 Ocelová nosná lišta; 35 × 15 mm; Tloušťka 1,5 mm; Délka 2 m; Neděrovaná; Podobné EN 60715 [www.wago.com/210-114](http://www.wago.com/210-114)

















**Obj. č.: 210-115**  
 Ocelová nosná lišta; 35 × 7,5 mm; Tloušťka 1 mm; Délka 2 m; Děrovaná; Dle normy EN 60715; Šířka otvorů 18 mm; vzdálenost mezi otvory 25 mm [www.wago.com/210-115](http://www.wago.com/210-115)

	<b>Obj. č.: 210-118</b> Ocelová nosná lišta; 35 × 15 mm; Tloušťka 2,3 mm; Délka 2 m; Neděrovaná; Dle normy EN 60715	<a href="http://www.wago.com/210-118">www.wago.com/210-118</a>
	<b>Obj. č.: 210-196</b> Hliníková nosná lišta; 35 × 8,2 mm; Tloušťka 1,6 mm; Délka 2 m; Neděrovaná; Podobné EN 60715; Stříbrná	<a href="http://www.wago.com/210-196">www.wago.com/210-196</a>
	<b>Obj. č.: 210-197</b> Ocelová nosná lišta; 35 × 15 mm; Tloušťka 1,5 mm; Délka 2 m; Děrovaná; Podobné EN 60715	<a href="http://www.wago.com/210-197">www.wago.com/210-197</a>
	<b>Obj. č.: 210-198</b> Měděná nosná lišta; 35 × 15 mm; Tloušťka 2,3 mm; Délka 2 m; Neděrovaná; Dle normy EN 60715; Měděná	<a href="http://www.wago.com/210-198">www.wago.com/210-198</a>
	<b>Obj. č.: 210-504</b> Ocelová nosná lišta; 35 × 7,5 mm; Tloušťka 1 mm; Délka 2 m; Děrovaná; Pásově zinkováno; Dle normy EN 60715	<a href="http://www.wago.com/210-504">www.wago.com/210-504</a>
	<b>Obj. č.: 210-505</b> Ocelová nosná lišta; 35 × 7,5 mm; Tloušťka 1 mm; Délka 2 m; Neděrovaná; Pásově zinkováno; Dle normy EN 60715	<a href="http://www.wago.com/210-505">www.wago.com/210-505</a>
	<b>Obj. č.: 210-506</b> Ocelová nosná lišta; 35 × 15 mm; Tloušťka 1,5 mm; Délka 2 m; Neděrovaná; Pásově zinkováno; Podobné EN 60715	<a href="http://www.wago.com/210-506">www.wago.com/210-506</a>
	<b>Obj. č.: 210-508</b> Ocelová nosná lišta; 35 × 15 mm; Tloušťka 1,5 mm; Délka 2 m; Děrovaná; Pásově zinkováno; Podobné EN 60715	<a href="http://www.wago.com/210-508">www.wago.com/210-508</a>
<b>Insulation stop</b>		
	<b>Obj. č.: 280-470</b> Izolační zarážka; 0,08–0,2 mm <sup>2</sup> „e“ (0,14 mm <sup>2</sup> „f“); 5 ks/pás; Bílá	<a href="http://www.wago.com/280-470">www.wago.com/280-470</a>
	<b>Obj. č.: 280-471</b> Izolační zarážka; 0,25–0,5 mm <sup>2</sup> ; 5 ks/pás; Světle šedá	<a href="http://www.wago.com/280-471">www.wago.com/280-471</a>
	<b>Obj. č.: 280-472</b> Izolační zarážka; 0,75–1 mm <sup>2</sup> ; 5 ks/pás	<a href="http://www.wago.com/280-472">www.wago.com/280-472</a>
<b>Female plug</b>		
	<b>Obj. č.: 232-132/005-000</b> Female connector for rail-mount terminal blocks; Rovné provedení; Rozteč 5 mm; 2pól.; Šedá	<a href="http://www.wago.com/232-132/005-000">www.wago.com/232-132/005-000</a>
	<b>Obj. č.: 232-132/005-000/039-000</b> Female connector for rail-mount terminal blocks; straight; Locking lever; Pin spacing 5 mm; 3-pole; gray	<a href="http://www.wago.com/232-132/005-000/039-000">www.wago.com/232-132/005-000/039-000</a>
	<b>Obj. č.: 232-133/005-000</b> Female connector for rail-mount terminal blocks; Rovné provedení; Rozteč 5 mm; 3pól.; Šedá	<a href="http://www.wago.com/232-133/005-000">www.wago.com/232-133/005-000</a>
	<b>Obj. č.: 232-133/005-000/039-000</b> Female connector for rail-mount terminal blocks; Rovné provedení; Blokovací západka; Rozteč 5 mm; 3pól.; Šedá	<a href="http://www.wago.com/232-133/005-000/039-000">www.wago.com/232-133/005-000/039-000</a>
	<b>Obj. č.: 232-134/005-000</b> Female connector for rail-mount terminal blocks; Rovné provedení; Rozteč 5 mm; 4pól.; Šedá	<a href="http://www.wago.com/232-134/005-000">www.wago.com/232-134/005-000</a>
	<b>Obj. č.: 232-134/005-000/039-000</b>	

	Female connector for rail-mount terminal blocks; Rovné provedení; Blokovací západka; Rozteč 5 mm; 4pól.; Šedá	<a href="http://www.wago.com/232-134/005-000/039-000">www.wago.com/232-134/005-000/039-000</a>
	<b>Obj. č.: 232-135/005-000</b> Female connector for rail-mount terminal blocks; Rovné provedení; Rozteč 5 mm; 5pól.; Šedá	<a href="http://www.wago.com/232-135/005-000">www.wago.com/232-135/005-000</a>
	<b>Obj. č.: 232-135/005-000/039-000</b> Female connector for rail-mount terminal blocks; Rovné provedení; Blokovací západka; Rozteč 5 mm; 5pól.; Šedá	<a href="http://www.wago.com/232-135/005-000/039-000">www.wago.com/232-135/005-000/039-000</a>
	<b>Obj. č.: 232-136/005-000</b> Female connector for rail-mount terminal blocks; Rovné provedení; Rozteč 5 mm; 6pól.; Šedá	<a href="http://www.wago.com/232-136/005-000">www.wago.com/232-136/005-000</a>
	<b>Obj. č.: 232-136/005-000/039-000</b> Female connector for rail-mount terminal blocks; Rovné provedení; Blokovací západka; Rozteč 5 mm; 6pól.; Šedá	<a href="http://www.wago.com/232-136/005-000/039-000">www.wago.com/232-136/005-000/039-000</a>
	<b>Obj. č.: 232-137/005-000</b> Female connector for rail-mount terminal blocks; Rovné provedení; Rozteč 5 mm; 7pól.; Šedá	<a href="http://www.wago.com/232-137/005-000">www.wago.com/232-137/005-000</a>
	<b>Obj. č.: 232-137/005-000/039-000</b> Female connector for rail-mount terminal blocks; Rovné provedení; Blokovací západka; Rozteč 5 mm; 7pól.; Šedá	<a href="http://www.wago.com/232-137/005-000/039-000">www.wago.com/232-137/005-000/039-000</a>
	<b>Obj. č.: 232-138/005-000</b> Female connector for rail-mount terminal blocks; Rovné provedení; Rozteč 5 mm; 8pól.; Šedá	<a href="http://www.wago.com/232-138/005-000">www.wago.com/232-138/005-000</a>
	<b>Obj. č.: 232-138/005-000/039-000</b> Female connector for rail-mount terminal blocks; Rovné provedení; Blokovací západka; Rozteč 5 mm; 8pól.; Šedá	<a href="http://www.wago.com/232-138/005-000/039-000">www.wago.com/232-138/005-000/039-000</a>
	<b>Obj. č.: 232-139/005-000</b> Female connector for rail-mount terminal blocks; Rovné provedení; Rozteč 5 mm; 9pól.; Šedá	<a href="http://www.wago.com/232-139/005-000">www.wago.com/232-139/005-000</a>
	<b>Obj. č.: 232-139/005-000/039-000</b> Female connector for rail-mount terminal blocks; Rovné provedení; Blokovací západka; Rozteč 5 mm; 9pól.; Šedá	<a href="http://www.wago.com/232-139/005-000/039-000">www.wago.com/232-139/005-000/039-000</a>
	<b>Obj. č.: 232-140/005-000</b> Female connector for rail-mount terminal blocks; Rovné provedení; Rozteč 5 mm; 10pól.; Šedá	<a href="http://www.wago.com/232-140/005-000">www.wago.com/232-140/005-000</a>
	<b>Obj. č.: 232-140/005-000/039-000</b> Female connector for rail-mount terminal blocks; Rovné provedení; Blokovací západka; Rozteč 5 mm; 10pól.; Šedá	<a href="http://www.wago.com/232-140/005-000/039-000">www.wago.com/232-140/005-000/039-000</a>
	<b>Obj. č.: 232-142/005-000</b> Female connector for rail-mount terminal blocks; Rovné provedení; Rozteč 5 mm; 12pól.; Šedá	<a href="http://www.wago.com/232-142/005-000">www.wago.com/232-142/005-000</a>
	<b>Obj. č.: 232-142/005-000/039-000</b> Female connector for rail-mount terminal blocks; Rovné provedení; Blokovací západka; Rozteč 5 mm; 12pól.; Šedá	<a href="http://www.wago.com/232-142/005-000/039-000">www.wago.com/232-142/005-000/039-000</a>

	<b>Obj. č.: 232-146/005-000</b> Female connector for rail-mount terminal blocks; Rovné provedení; Rozteč 5 mm; 16pól.; Šedá	<a href="http://www.wago.com/232-146/005-000">www.wago.com/232-146/005-000</a>
	<b>Obj. č.: 232-146/005-000/039-000</b> Female connector for rail-mount terminal blocks; Rovné provedení; Blokovací západka; Rozteč 5 mm; 16pól.; Šedá	<a href="http://www.wago.com/232-146/005-000/039-000">www.wago.com/232-146/005-000/039-000</a>
	<b>Obj. č.: 232-147/005-000/039-000</b> Female connector for rail-mount terminal blocks; straight; Locking lever; Pin spacing 5 mm; 17-pole; gray	<a href="http://www.wago.com/232-147/005-000/039-000">www.wago.com/232-147/005-000/039-000</a>
	<b>Obj. č.: 232-150/005-000</b> Female connector for rail-mount terminal blocks; Rovné provedení; Rozteč 5 mm; 20pól.; Šedá	<a href="http://www.wago.com/232-150/005-000">www.wago.com/232-150/005-000</a>
	<b>Obj. č.: 232-150/005-000/039-000</b> Female connector for rail-mount terminal blocks; straight; Locking lever; Pin spacing 5 mm; 20-pole; gray	<a href="http://www.wago.com/232-150/005-000/039-000">www.wago.com/232-150/005-000/039-000</a>
	<b>Obj. č.: 232-232/005-000</b> Female connector for rail-mount terminal blocks; Úhlové provedení; Rozteč 5 mm; 2pól.; Šedá	<a href="http://www.wago.com/232-232/005-000">www.wago.com/232-232/005-000</a>
	<b>Obj. č.: 232-232/005-000/039-000</b> Female connector for rail-mount terminal blocks; Úhlové provedení; Blokovací západka; Rozteč 5 mm; 2pól.; Šedá	<a href="http://www.wago.com/232-232/005-000/039-000">www.wago.com/232-232/005-000/039-000</a>
	<b>Obj. č.: 232-233/005-000</b> Female connector for rail-mount terminal blocks; Úhlové provedení; Rozteč 5 mm; 3pól.; Šedá	<a href="http://www.wago.com/232-233/005-000">www.wago.com/232-233/005-000</a>
	<b>Obj. č.: 232-233/005-000/039-000</b> Female connector for rail-mount terminal blocks; angled; Locking lever; Pin spacing 5 mm; 3-pole; gray	<a href="http://www.wago.com/232-233/005-000/039-000">www.wago.com/232-233/005-000/039-000</a>
	<b>Obj. č.: 232-234/005-000</b> Female connector for rail-mount terminal blocks; Úhlové provedení; Rozteč 5 mm; 4pól.; Šedá	<a href="http://www.wago.com/232-234/005-000">www.wago.com/232-234/005-000</a>
	<b>Obj. č.: 232-234/005-000/039-000</b> Female connector for rail-mount terminal blocks; Úhlové provedení; Blokovací západka; Rozteč 5 mm; 4pól.; Šedá	<a href="http://www.wago.com/232-234/005-000/039-000">www.wago.com/232-234/005-000/039-000</a>
	<b>Obj. č.: 232-235/005-000</b> Female connector for rail-mount terminal blocks; Úhlové provedení; Rozteč 5 mm; 5pól.; Šedá	<a href="http://www.wago.com/232-235/005-000">www.wago.com/232-235/005-000</a>
	<b>Obj. č.: 232-235/005-000/039-000</b> Female connector for rail-mount terminal blocks; Úhlové provedení; Blokovací západka; Rozteč 5 mm; 5pól.; Šedá	<a href="http://www.wago.com/232-235/005-000/039-000">www.wago.com/232-235/005-000/039-000</a>
	<b>Obj. č.: 232-236/005-000</b> Female connector for rail-mount terminal blocks; Úhlové provedení; Rozteč 5 mm; 6pól.; Šedá	<a href="http://www.wago.com/232-236/005-000">www.wago.com/232-236/005-000</a>
	<b>Obj. č.: 232-236/005-000/039-000</b>	

	Female connector for rail-mount terminal blocks; angled; Locking lever; Pin spacing 5 mm; 6-pole; gray	<a href="http://www.wago.com/232-236/005-000/039-000">www.wago.com/232-236/005-000/039-000</a>
	<b>Obj. č.: 232-237/005-000</b> Female connector for rail-mount terminal blocks; Úhlové provedení; Rozteč 5 mm; 7pól.; Šedá	<a href="http://www.wago.com/232-237/005-000">www.wago.com/232-237/005-000</a>
	<b>Obj. č.: 232-238/005-000</b> Female connector for rail-mount terminal blocks; Úhlové provedení; Rozteč 5 mm; 8pól.; Šedá	<a href="http://www.wago.com/232-238/005-000">www.wago.com/232-238/005-000</a>
	<b>Obj. č.: 232-239/005-000</b> Female connector for rail-mount terminal blocks; Úhlové provedení; Rozteč 5 mm; 9pól.; Šedá	<a href="http://www.wago.com/232-239/005-000">www.wago.com/232-239/005-000</a>
	<b>Obj. č.: 232-240/005-000</b> Female connector for rail-mount terminal blocks; Úhlové provedení; Rozteč 5 mm; 10pól.; Šedá	<a href="http://www.wago.com/232-240/005-000">www.wago.com/232-240/005-000</a>
	<b>Obj. č.: 232-240/005-000/039-000</b> Female connector for rail-mount terminal blocks; Úhlové provedení; Blokovací západka; Rozteč 5 mm; 10pól.; Šedá	<a href="http://www.wago.com/232-240/005-000/039-000">www.wago.com/232-240/005-000/039-000</a>
	<b>Obj. č.: 232-242/005-000</b> Female connector for rail-mount terminal blocks; Úhlové provedení; Rozteč 5 mm; 12pól.; Šedá	<a href="http://www.wago.com/232-242/005-000">www.wago.com/232-242/005-000</a>
	<b>Obj. č.: 232-242/005-000/039-000</b> Female connector for rail-mount terminal blocks; Úhlové provedení; Blokovací západka; Rozteč 5 mm; 12pól.; Šedá	<a href="http://www.wago.com/232-242/005-000/039-000">www.wago.com/232-242/005-000/039-000</a>
	<b>Obj. č.: 232-246/005-000</b> Female connector for rail-mount terminal blocks; Úhlové provedení; Rozteč 5 mm; 16pól.; Šedá	<a href="http://www.wago.com/232-246/005-000">www.wago.com/232-246/005-000</a>
	<b>Obj. č.: 232-246/005-000/039-000</b> Female connector for rail-mount terminal blocks; Úhlové provedení; Blokovací západka; Rozteč 5 mm; 16pól.; Šedá	<a href="http://www.wago.com/232-246/005-000/039-000">www.wago.com/232-246/005-000/039-000</a>
	<b>Obj. č.: 232-250/005-000</b> Female connector for rail-mount terminal blocks; Úhlové provedení; Rozteč 5 mm; 20pól.; Šedá	<a href="http://www.wago.com/232-250/005-000">www.wago.com/232-250/005-000</a>
	<b>Obj. č.: 232-250/005-000/039-000</b> Female connector for rail-mount terminal blocks; angled; Locking lever; Pin spacing 5 mm; 20-pole; gray	<a href="http://www.wago.com/232-250/005-000/039-000">www.wago.com/232-250/005-000/039-000</a>
	<b>Obj. č.: 232-732/005-000</b> Female connector for rail-mount terminal blocks; Rovné provedení; Rozteč 7,5 mm; 2pól.; Šedá	<a href="http://www.wago.com/232-732/005-000">www.wago.com/232-732/005-000</a>
	<b>Obj. č.: 232-733/005-000</b> Female connector for rail-mount terminal blocks; Rovné provedení; Rozteč 7,5 mm; 3pól.; Šedá	<a href="http://www.wago.com/232-733/005-000">www.wago.com/232-733/005-000</a>
	<b>Obj. č.: 232-734/005-000</b> Female connector for rail-mount terminal blocks; Rovné provedení; Rozteč 7,5 mm; 4pól.; Šedá	<a href="http://www.wago.com/232-734/005-000">www.wago.com/232-734/005-000</a>

**Obj. č.: 232-734/005-000/039-000**

Female connector for rail-mount terminal blocks; Rovné provedení; Rozteč 7,5 mm; 4pól.; Šedá

[www.wago.com/232-734/005-000/039-000](http://www.wago.com/232-734/005-000/039-000)**Obj. č.: 232-735/005-000**

Female connector for rail-mount terminal blocks; Rovné provedení; Rozteč 7,5 mm; 5pól.; Šedá

[www.wago.com/232-735/005-000](http://www.wago.com/232-735/005-000)**Obj. č.: 232-735/005-000/039-000**

Female connector for rail-mount terminal blocks; Rovné provedení; Rozteč 7,5 mm; 5pól.; Šedá

[www.wago.com/232-735/005-000/039-000](http://www.wago.com/232-735/005-000/039-000)**Obj. č.: 232-736/005-000**

Female connector for rail-mount terminal blocks; Rovné provedení; Rozteč 7,5 mm; 6pól.; Šedá

[www.wago.com/232-736/005-000](http://www.wago.com/232-736/005-000)**Obj. č.: 232-736/005-000/039-000**

Female connector for rail-mount terminal blocks; Rovné provedení; Rozteč 7,5 mm; 6pól.; Šedá

[www.wago.com/232-736/005-000/039-000](http://www.wago.com/232-736/005-000/039-000)**Obj. č.: 232-738/005-000**

Female connector for rail-mount terminal blocks; Rovné provedení; Rozteč 7,5 mm; 8pól.; Šedá

[www.wago.com/232-738/005-000](http://www.wago.com/232-738/005-000)**Obj. č.: 232-740/005-000**

Female connector for rail-mount terminal blocks; Rovné provedení; Rozteč 7,5 mm; 10pól.; Šedá

[www.wago.com/232-740/005-000](http://www.wago.com/232-740/005-000)**Obj. č.: 232-742/005-000**

Female connector for rail-mount terminal blocks; Rovné provedení; Rozteč 7,5 mm; 12pól.; Šedá

[www.wago.com/232-742/005-000](http://www.wago.com/232-742/005-000)**Obj. č.: 232-832/005-000**

Pružinová svorkovnice THT; 0.6 x 1.0 mm solder pin; Úhlové provedení; Rozteč 7,5 mm; 2pól.; Šedá

[www.wago.com/232-832/005-000](http://www.wago.com/232-832/005-000)**Obj. č.: 232-833/005-000**

Pružinová svorkovnice THT; 0.6 x 1.0 mm solder pin; Úhlové provedení; Rozteč 7,5 mm; 3pól.; Šedá

[www.wago.com/232-833/005-000](http://www.wago.com/232-833/005-000)**Obj. č.: 232-834/005-000**

Pružinová svorkovnice THT; 0.6 x 1.0 mm solder pin; Úhlové provedení; Rozteč 7,5 mm; 4pól.; Šedá

[www.wago.com/232-834/005-000](http://www.wago.com/232-834/005-000)**Obj. č.: 232-836/005-000**

Pružinová svorkovnice THT; 0.6 x 1.0 mm solder pin; Úhlové provedení; Rozteč 7,5 mm; 6pól.; Šedá















[www.wago.com/232-836/005-000](http://www.wago.com/232-836/005-000)**Obj. č.: 232-836/005-000/039-000**

Pružinová svorkovnice THT; 0.6 x 1.0 mm solder pin; Úhlové provedení; Blokovací západka; Rozteč 7,5 mm; 6pól.; Šedá

[www.wago.com/232-836/005-000/039-000](http://www.wago.com/232-836/005-000/039-000)**Obj. č.: 232-840/005-000**

Pružinová svorkovnice THT; 0.6 x 1.0 mm solder pin; Úhlové provedení; Rozteč 7,5 mm; 10pól.; Šedá

[www.wago.com/232-840/005-000](http://www.wago.com/232-840/005-000)

	<b>Obj. č.: 232-842/005-000</b> THT female header; 0.6 x 1.0 mm solder pin; angled; Pin spacing 7.5 mm; 12-pole; gray	<a href="http://www.wago.com/232-842/005-000">www.wago.com/232-842/005-000</a>
	<b>Obj. č.: 722-132/005-000</b> Female connector for rail-mount terminal blocks; Rovné provedení; 100% ochrana proti chybnému zapojení; Rozteč 5 mm; 2pól.; Světle šedá	<a href="http://www.wago.com/722-132/005-000">www.wago.com/722-132/005-000</a>
	<b>Obj. č.: 722-132/005-000/039-000</b> Female connector for rail-mount terminal blocks; Rovné provedení; 100% ochrana proti chybnému zapojení; Blokovací západka; Rozteč 5 mm; 3pól.; Světle šedá	<a href="http://www.wago.com/722-132/005-000/039-000">www.wago.com/722-132/005-000/039-000</a>
	<b>Obj. č.: 722-133/005-000</b> Female connector for rail-mount terminal blocks; Rovné provedení; 100% ochrana proti chybnému zapojení; Rozteč 5 mm; 3pól.; Světle šedá	<a href="http://www.wago.com/722-133/005-000">www.wago.com/722-133/005-000</a>
	<b>Obj. č.: 722-133/005-000/039-000</b> Female connector for rail-mount terminal blocks; Rovné provedení; 100% ochrana proti chybnému zapojení; Blokovací západka; Rozteč 5 mm; 3pól.; Světle šedá	<a href="http://www.wago.com/722-133/005-000/039-000">www.wago.com/722-133/005-000/039-000</a>
	<b>Obj. č.: 722-134/005-000</b> Female connector for rail-mount terminal blocks; Rovné provedení; 100% ochrana proti chybnému zapojení; Rozteč 5 mm; 4pól.; Světle šedá	<a href="http://www.wago.com/722-134/005-000">www.wago.com/722-134/005-000</a>
	<b>Obj. č.: 722-134/005-000/039-000</b> Female connector for rail-mount terminal blocks; Rovné provedení; 100% ochrana proti chybnému zapojení; Blokovací západka; Rozteč 5 mm; 4pól.; Světle šedá	<a href="http://www.wago.com/722-134/005-000/039-000">www.wago.com/722-134/005-000/039-000</a>
	<b>Obj. č.: 722-135/005-000</b> Female connector for rail-mount terminal blocks; Rovné provedení; 100% ochrana proti chybnému zapojení; Rozteč 5 mm; 5pól.; Světle šedá	<a href="http://www.wago.com/722-135/005-000">www.wago.com/722-135/005-000</a>
	<b>Obj. č.: 722-135/005-000/039-000</b> Female connector for rail-mount terminal blocks; Rovné provedení; 100% ochrana proti chybnému zapojení; Blokovací západka; Rozteč 5 mm; 5pól.; Světle šedá	<a href="http://www.wago.com/722-135/005-000/039-000">www.wago.com/722-135/005-000/039-000</a>
	<b>Obj. č.: 722-136/005-000</b> Female connector for rail-mount terminal blocks; Rovné provedení; 100% ochrana proti chybnému zapojení; Rozteč 5 mm; 6pól.; Světle šedá	<a href="http://www.wago.com/722-136/005-000">www.wago.com/722-136/005-000</a>
	<b>Obj. č.: 722-136/005-000/039-000</b> Female connector for rail-mount terminal blocks; Rovné provedení; 100% ochrana proti chybnému zapojení; Blokovací západka; Rozteč 5 mm; 6pól.; Světle šedá	<a href="http://www.wago.com/722-136/005-000/039-000">www.wago.com/722-136/005-000/039-000</a>
	<b>Obj. č.: 722-137/005-000</b> Female connector for rail-mount terminal blocks; Rovné provedení; 100% ochrana proti chybnému zapojení; Rozteč 5 mm; 7pól.; Světle šedá	<a href="http://www.wago.com/722-137/005-000">www.wago.com/722-137/005-000</a>
	<b>Obj. č.: 722-137/005-000/039-000</b> Female connector for rail-mount terminal blocks; Rovné provedení; 100% ochrana proti chybnému zapojení; Blokovací západka; Rozteč 5 mm; 7pól.; Světle šedá	<a href="http://www.wago.com/722-137/005-000/039-000">www.wago.com/722-137/005-000/039-000</a>
	<b>Obj. č.: 722-138/005-000</b> Female connector for rail-mount terminal blocks; Rovné provedení; 100% ochrana proti chybnému zapojení; Rozteč 5 mm; 8pól.; Světle šedá	<a href="http://www.wago.com/722-138/005-000">www.wago.com/722-138/005-000</a>
	<b>Obj. č.: 722-138/005-000/039-000</b> Female connector for rail-mount terminal blocks; Rovné provedení; 100% ochrana proti chybnému zapojení; Blokovací západka; Rozteč 5 mm; 8pól.; Světle šedá	<a href="http://www.wago.com/722-138/005-000/039-000">www.wago.com/722-138/005-000/039-000</a>



zapojení; Blokovací západka; Rozteč 5 mm; 8pól.; Světle šedá



**Obj. č.: 722-139/005-000**

Female connector for rail-mount terminal blocks; Rovné provedení; 100% ochrana proti chybnému zapojení; Rozteč 5 mm; 9pól.; Světle šedá

[www.wago.com/722-139/005-000](http://www.wago.com/722-139/005-000)



**Obj. č.: 722-139/005-000/039-000**

Female connector for rail-mount terminal blocks; Rovné provedení; 100% ochrana proti chybnému zapojení; Blokovací západka; Rozteč 5 mm; 9pól.; Světle šedá

[www.wago.com/722-139/005-000/039-000](http://www.wago.com/722-139/005-000/039-000)



**Obj. č.: 722-140/005-000**

Female connector for rail-mount terminal blocks; Rovné provedení; 100% ochrana proti chybnému zapojení; Rozteč 5 mm; 10pól.; Světle šedá

[www.wago.com/722-140/005-000](http://www.wago.com/722-140/005-000)



**Obj. č.: 722-140/005-000/039-000**

Female connector for rail-mount terminal blocks; Rovné provedení; 100% ochrana proti chybnému zapojení; Blokovací západka; Rozteč 5 mm; 10pól.; Světle šedá

[www.wago.com/722-140/005-000/039-000](http://www.wago.com/722-140/005-000/039-000)



**Obj. č.: 722-141/005-000**

Female connector for rail-mount terminal blocks; Rovné provedení; 100% ochrana proti chybnému zapojení; Rozteč 5 mm; 11pól.; Světle šedá

[www.wago.com/722-141/005-000](http://www.wago.com/722-141/005-000)



**Obj. č.: 722-142/005-000**

Female connector for rail-mount terminal blocks; Rovné provedení; 100% ochrana proti chybnému zapojení; Rozteč 5 mm; 12pól.; Světle šedá

[www.wago.com/722-142/005-000](http://www.wago.com/722-142/005-000)



**Obj. č.: 722-142/005-007/039-000**

Female connector for rail-mount terminal blocks; Šedá

[www.wago.com/722-142/005-007/039-000](http://www.wago.com/722-142/005-007/039-000)



**Obj. č.: 722-143/005-000**

Female connector for rail-mount terminal blocks; Rovné provedení; 100% ochrana proti chybnému zapojení; Rozteč 5 mm; 13pól.; Světle šedá

[www.wago.com/722-143/005-000](http://www.wago.com/722-143/005-000)



**Obj. č.: 722-144/005-000**

Female connector for rail-mount terminal blocks; straight; 100% protected against mismatching; Pin spacing 5 mm; 14-pole; light gray

[www.wago.com/722-144/005-000](http://www.wago.com/722-144/005-000)



**Obj. č.: 722-144/005-000/039-000**

Female connector for rail-mount terminal blocks; Rovné provedení; 100% ochrana proti chybnému zapojení; Blokovací západka; Rozteč 5 mm; 14pól.; Světle šedá

[www.wago.com/722-144/005-000/039-000](http://www.wago.com/722-144/005-000/039-000)



**Obj. č.: 722-145/005-000**

Female connector for rail-mount terminal blocks; Rovné provedení; 100% ochrana proti chybnému zapojení; Rozteč 5 mm; 15pól.; Světle šedá

[www.wago.com/722-145/005-000](http://www.wago.com/722-145/005-000)



**Obj. č.: 722-146/005-000**

Female connector for rail-mount terminal blocks; Rovné provedení; 100% ochrana proti chybnému zapojení; Rozteč 5 mm; 16pól.; Světle šedá

[www.wago.com/722-146/005-000](http://www.wago.com/722-146/005-000)



**Obj. č.: 722-146/005-000/039-000**

Female connector for rail-mount terminal blocks; straight; 100% protected against mismatching; Locking lever; Pin spacing 5 mm; 16-pole; light gray

[www.wago.com/722-146/005-000/039-000](http://www.wago.com/722-146/005-000/039-000)

















**Obj. č.: 722-150/005-000**















Female connector for rail-mount terminal blocks; Rovné provedení; 100% ochrana proti chybnému zapojení; Rozteč 5 mm; 20pól.; Světle šedá

















[www.wago.com/722-150/005-000](http://www.wago.com/722-150/005-000)















**Obj. č.: 722-150/005-000/039-000**















	Female connector for rail-mount terminal blocks; Rovné provedení; 100% ochrana proti chybnému zapojení; Blokovací západka; Rozteč 5 mm; 20pól.; Světlo šedá	<a href="http://www.wago.com/722-150/005-000/039-000">www.wago.com/722-150/005-000/039-000</a>
	<b>Obj. č.: 722-232/005-000</b> Female connector for rail-mount terminal blocks; Úhlové provedení; 100% ochrana proti chybnému zapojení; Rozteč 5 mm; 3pól.; Světlo šedá	<a href="http://www.wago.com/722-232/005-000">www.wago.com/722-232/005-000</a>
	<b>Obj. č.: 722-232/005-000/039-000</b> Female connector for rail-mount terminal blocks; Úhlové provedení; 100% ochrana proti chybnému zapojení; Blokovací západka; Rozteč 5 mm; 3pól.; Světlo šedá	<a href="http://www.wago.com/722-232/005-000/039-000">www.wago.com/722-232/005-000/039-000</a>
	<b>Obj. č.: 722-233/005-000</b> Female connector for rail-mount terminal blocks; Úhlové provedení; 100% ochrana proti chybnému zapojení; Rozteč 5 mm; 3pól.; Světlo šedá	<a href="http://www.wago.com/722-233/005-000">www.wago.com/722-233/005-000</a>
	<b>Obj. č.: 722-233/005-000/039-000</b> Female connector for rail-mount terminal blocks; Úhlové provedení; 100% ochrana proti chybnému zapojení; Blokovací západka; Rozteč 5 mm; 3pól.; Světlo šedá	<a href="http://www.wago.com/722-233/005-000/039-000">www.wago.com/722-233/005-000/039-000</a>
	<b>Obj. č.: 722-234/005-000</b> Female connector for rail-mount terminal blocks; Úhlové provedení; 100% ochrana proti chybnému zapojení; Rozteč 5 mm; 4pól.; Světlo šedá	<a href="http://www.wago.com/722-234/005-000">www.wago.com/722-234/005-000</a>
	<b>Obj. č.: 722-234/005-000/039-000</b> Female connector for rail-mount terminal blocks; Úhlové provedení; 100% ochrana proti chybnému zapojení; Blokovací západka; Rozteč 5 mm; 4pól.; Světlo šedá	<a href="http://www.wago.com/722-234/005-000/039-000">www.wago.com/722-234/005-000/039-000</a>
	<b>Obj. č.: 722-235/005-000</b> Female connector for rail-mount terminal blocks; Úhlové provedení; 100% ochrana proti chybnému zapojení; Rozteč 5 mm; 5pól.; Světlo šedá	<a href="http://www.wago.com/722-235/005-000">www.wago.com/722-235/005-000</a>
	<b>Obj. č.: 722-235/005-000/039-000</b> Female connector for rail-mount terminal blocks; Úhlové provedení; 100% ochrana proti chybnému zapojení; Blokovací západka; Rozteč 5 mm; 5pól.; Světlo šedá	<a href="http://www.wago.com/722-235/005-000/039-000">www.wago.com/722-235/005-000/039-000</a>
	<b>Obj. č.: 722-236/005-000</b> Female connector for rail-mount terminal blocks; Úhlové provedení; 100% ochrana proti chybnému zapojení; Rozteč 5 mm; 6pól.; Světlo šedá	<a href="http://www.wago.com/722-236/005-000">www.wago.com/722-236/005-000</a>
	<b>Obj. č.: 722-236/005-000/039-000</b> Female connector for rail-mount terminal blocks; Úhlové provedení; 100% ochrana proti chybnému zapojení; Blokovací západka; Rozteč 5 mm; 6pól.; Světlo šedá	<a href="http://www.wago.com/722-236/005-000/039-000">www.wago.com/722-236/005-000/039-000</a>
	<b>Obj. č.: 722-237/005-000</b> Female connector for rail-mount terminal blocks; Úhlové provedení; 100% ochrana proti chybnému zapojení; Rozteč 5 mm; 7pól.; Světlo šedá	<a href="http://www.wago.com/722-237/005-000">www.wago.com/722-237/005-000</a>
	<b>Obj. č.: 722-237/005-000/039-000</b> Female connector for rail-mount terminal blocks; Úhlové provedení; 100% ochrana proti chybnému zapojení; Blokovací západka; Rozteč 5 mm; 7pól.; Světlo šedá	<a href="http://www.wago.com/722-237/005-000/039-000">www.wago.com/722-237/005-000/039-000</a>
	<b>Obj. č.: 722-238/005-000</b> Female connector for rail-mount terminal blocks; Úhlové provedení; 100% ochrana proti chybnému zapojení; Rozteč 5 mm; 8pól.; Světlo šedá	<a href="http://www.wago.com/722-238/005-000">www.wago.com/722-238/005-000</a>
	<b>Obj. č.: 722-239/005-000</b> Female connector for rail-mount terminal blocks; Úhlové provedení; 100% ochrana proti chybnému zapojení; Rozteč 5 mm; 9pól.; Světlo šedá	<a href="http://www.wago.com/722-239/005-000">www.wago.com/722-239/005-000</a>

	<b>Obj. č.: 722-239/005-000/039-000</b> Female connector for rail-mount terminal blocks; angled; 100% protected against mismatching; Locking lever; Pin spacing 5 mm; 9-pole; light gray	<a href="http://www.wago.com/722-239/005-000/039-000">www.wago.com/722-239/005-000/039-000</a>
	<b>Obj. č.: 722-240/005-000</b> Female connector for rail-mount terminal blocks; Úhlové provedení; 100% ochrana proti chybnému zapojení; Rozteč 5 mm; 10pól.; Světle šedá	<a href="http://www.wago.com/722-240/005-000">www.wago.com/722-240/005-000</a>
	<b>Obj. č.: 722-240/005-000/039-000</b> Female connector for rail-mount terminal blocks; Úhlové provedení; 100% ochrana proti chybnému zapojení; Blokovací západka; Rozteč 5 mm; 10pól.; Světle šedá	<a href="http://www.wago.com/722-240/005-000/039-000">www.wago.com/722-240/005-000/039-000</a>
	<b>Obj. č.: 722-241/005-000</b> Female connector for rail-mount terminal blocks; Úhlové provedení; 100% ochrana proti chybnému zapojení; Rozteč 5 mm; 11pól.; Světle šedá	<a href="http://www.wago.com/722-241/005-000">www.wago.com/722-241/005-000</a>
	<b>Obj. č.: 722-242/005-000</b> Female connector for rail-mount terminal blocks; Úhlové provedení; 100% ochrana proti chybnému zapojení; Rozteč 5 mm; 12pól.; Světle šedá	<a href="http://www.wago.com/722-242/005-000">www.wago.com/722-242/005-000</a>
	<b>Obj. č.: 722-242/005-000/039-000</b> Female connector for rail-mount terminal blocks; angled; 100% protected against mismatching; Locking lever; Pin spacing 5 mm; 12-pole; light gray	<a href="http://www.wago.com/722-242/005-000/039-000">www.wago.com/722-242/005-000/039-000</a>
	<b>Obj. č.: 722-243/005-000</b> Female connector for rail-mount terminal blocks; angled; 100% protected against mismatching; Pin spacing 5 mm; 13-pole; light gray	<a href="http://www.wago.com/722-243/005-000">www.wago.com/722-243/005-000</a>
	<b>Obj. č.: 722-244/005-000</b> Female connector for rail-mount terminal blocks; Úhlové provedení; 100% ochrana proti chybnému zapojení; Rozteč 5 mm; 14pól.; Světle šedá	<a href="http://www.wago.com/722-244/005-000">www.wago.com/722-244/005-000</a>
	<b>Obj. č.: 722-244/005-000/039-000</b> Female connector for rail-mount terminal blocks; Úhlové provedení; 100% ochrana proti chybnému zapojení; Blokovací západka; Rozteč 5 mm; 14pól.; Světle šedá	<a href="http://www.wago.com/722-244/005-000/039-000">www.wago.com/722-244/005-000/039-000</a>
	<b>Obj. č.: 722-246/005-000</b> Female connector for rail-mount terminal blocks; Úhlové provedení; 100% ochrana proti chybnému zapojení; Rozteč 5 mm; 16pól.; Světle šedá	<a href="http://www.wago.com/722-246/005-000">www.wago.com/722-246/005-000</a>
	<b>Obj. č.: 722-246/005-000/039-000</b> Female connector for rail-mount terminal blocks; Úhlové provedení; 100% ochrana proti chybnému zapojení; Blokovací západka; Rozteč 5 mm; 16pól.; Světle šedá	<a href="http://www.wago.com/722-246/005-000/039-000">www.wago.com/722-246/005-000/039-000</a>
	<b>Obj. č.: 722-250/005-000</b> Female connector for rail-mount terminal blocks; Úhlové provedení; 100% ochrana proti chybnému zapojení; Rozteč 5 mm; 20pól.; Světle šedá	<a href="http://www.wago.com/722-250/005-000">www.wago.com/722-250/005-000</a>
<b>General accessories</b>		
	<b>Obj. č.: 231-162/003-000</b> Male connector for rail-mount terminal blocks; 1.2 x 1.2 mm pins; Rovné provedení; Rozteč 5 mm; 2pól.; Šedá	<a href="http://www.wago.com/231-162/003-000">www.wago.com/231-162/003-000</a>
	<b>Obj. č.: 231-163/003-000</b> Male connector for rail-mount terminal blocks; 1.2 x 1.2 mm pins; Rovné provedení; Rozteč 5 mm; 3pól.; Šedá	<a href="http://www.wago.com/231-163/003-000">www.wago.com/231-163/003-000</a>
	<b>Obj. č.: 231-164/003-000</b>	

	Male connector for rail-mount terminal blocks; 1.2 x 1.2 mm pins; Rovné provedení; Rozteč 5 mm; 4pól.; Šedá	<a href="http://www.wago.com/231-164/003-000">www.wago.com/231-164/003-000</a>
	<b>Obj. č.: 231-165/003-000</b> Male connector for rail-mount terminal blocks; 1.2 x 1.2 mm pins; Rovné provedení; Rozteč 5 mm; 5pól.; Šedá	<a href="http://www.wago.com/231-165/003-000">www.wago.com/231-165/003-000</a>
	<b>Obj. č.: 231-166/003-000</b> Male connector for rail-mount terminal blocks; 1.2 x 1.2 mm pins; Rovné provedení; Rozteč 5 mm; 6pól.; Šedá	<a href="http://www.wago.com/231-166/003-000">www.wago.com/231-166/003-000</a>
	<b>Obj. č.: 231-167/003-000</b> Male connector for rail-mount terminal blocks; 1.2 x 1.2 mm pins; Rovné provedení; Rozteč 5 mm; 7pól.; Šedá	<a href="http://www.wago.com/231-167/003-000">www.wago.com/231-167/003-000</a>
	<b>Obj. č.: 231-168/003-000</b> Male connector for rail-mount terminal blocks; 1.2 x 1.2 mm pins; Rovné provedení; Rozteč 5 mm; 8pól.; Šedá	<a href="http://www.wago.com/231-168/003-000">www.wago.com/231-168/003-000</a>
	<b>Obj. č.: 231-169/003-000</b> Male connector for rail-mount terminal blocks; 1.2 x 1.2 mm pins; Rovné provedení; Rozteč 5 mm; 9pól.; Šedá	<a href="http://www.wago.com/231-169/003-000">www.wago.com/231-169/003-000</a>
	<b>Obj. č.: 231-170/003-000</b> Male connector for rail-mount terminal blocks; 1.2 x 1.2 mm pins; Rovné provedení; Rozteč 5 mm; 10pól.; Šedá	<a href="http://www.wago.com/231-170/003-000">www.wago.com/231-170/003-000</a>
	<b>Obj. č.: 231-171/003-000</b> Male connector for rail-mount terminal blocks; 1.2 x 1.2 mm pins; Rovné provedení; Rozteč 5 mm; 11pól.; Šedá	<a href="http://www.wago.com/231-171/003-000">www.wago.com/231-171/003-000</a>
	<b>Obj. č.: 231-172/003-000</b> Male connector for rail-mount terminal blocks; 1.2 x 1.2 mm pins; Rovné provedení; Rozteč 5 mm; 12pól.; Šedá	<a href="http://www.wago.com/231-172/003-000">www.wago.com/231-172/003-000</a>
	<b>Obj. č.: 231-176/003-000</b> Male connector for rail-mount terminal blocks; 1.2 x 1.2 mm pins; Rovné provedení; Rozteč 5 mm; 16pól.; Šedá	<a href="http://www.wago.com/231-176/003-000">www.wago.com/231-176/003-000</a>
	<b>Obj. č.: 231-180/003-000</b> Male connector for rail-mount terminal blocks; 1.2 x 1.2 mm pins; Rovné provedení; Rozteč 5 mm; 20pól.; Šedá	<a href="http://www.wago.com/231-180/003-000">www.wago.com/231-180/003-000</a>
	<b>Obj. č.: 231-668</b> Zavírací kolíky; K uzavření nepotřebných kontaktních míst; Šedá	<a href="http://www.wago.com/231-668">www.wago.com/231-668</a>
	<b>Obj. č.: 231-669</b> Zavírací kolíky; K uzavření nepotřebných kontaktních míst; Oranžová	<a href="http://www.wago.com/231-669">www.wago.com/231-669</a>
	<b>Obj. č.: 249-105</b> Nosič skupinového označení	<a href="http://www.wago.com/249-105">www.wago.com/249-105</a>
	<b>Obj. č.: 280-404</b> Zkušební adaptér; Šířka 5 mm; Pro zkušební hrot 210-137 (Ø 2,3 mm); Vhodná pro svorky 1,5-4 mm²; Šedá	<a href="http://www.wago.com/280-404">www.wago.com/280-404</a>
	<b>Obj. č.: 280-418</b> Modul pro zkušební zástrčku; Možnost řadového připojení; Vhodný ke všem řadovým svorkám WAGO řad 280 a 780 s drážkou pro můstek v napájecí liště; Šedá	<a href="http://www.wago.com/280-418">www.wago.com/280-418</a>

	<b>Obj. č.: 280-419</b> Slepý modul; Možnost řadového připojení; K přeskočení svorek; Šedá	<a href="http://www.wago.com/280-419">www.wago.com/280-419</a>
	<b>Obj. č.: 280-803</b> Prázdný konektor; Šířka 10 mm; Typ 4; 2pól.; Šedá	<a href="http://www.wago.com/280-803">www.wago.com/280-803</a>
	<b>Obj. č.: 280-803/281-411</b> Zásuvný modul; 2pól.; S diodou 1N4007; Šířka 10 mm; Šedá	<a href="http://www.wago.com/280-803/281-411">www.wago.com/280-803/281-411</a>
	<b>Obj. č.: 280-803/281-413</b> Zásuvný modul; 2pól.; Červená LED dioda; DC 24 V; Šířka 10 mm; Šedá	<a href="http://www.wago.com/280-803/281-413">www.wago.com/280-803/281-413</a>
	<b>Obj. č.: 280-803/281-414</b> Zásuvný modul; 2pól.; Červená LED dioda; DC 48 V; Šířka 10 mm; Šedá	<a href="http://www.wago.com/280-803/281-414">www.wago.com/280-803/281-414</a>
	<b>Obj. č.: 280-803/281-415</b> Zásuvný modul; 2pól.; Červená LED dioda; Šířka 10 mm; Šedá	<a href="http://www.wago.com/280-803/281-415">www.wago.com/280-803/281-415</a>
	<b>Obj. č.: 280-803/281-416</b> Zásuvný modul; 2pól.; Červená LED dioda; Šířka 10 mm; Šedá	<a href="http://www.wago.com/280-803/281-416">www.wago.com/280-803/281-416</a>
	<b>Obj. č.: 280-803/281-417</b> Zásuvný modul; 2pól.; Šířka 10 mm; Šedá	<a href="http://www.wago.com/280-803/281-417">www.wago.com/280-803/281-417</a>
	<b>Obj. č.: 280-803/281-418</b> Zásuvný modul; 2pól.; Šířka 10 mm; Šedá	<a href="http://www.wago.com/280-803/281-418">www.wago.com/280-803/281-418</a>
	<b>Obj. č.: 280-803/281-420</b> Zásuvný modul; Pro základní svorky; 2pól.; S usměrňovací a LED diodou; Šířka 10 mm; Šedá	<a href="http://www.wago.com/280-803/281-420">www.wago.com/280-803/281-420</a>
	<b>Obj. č.: 280-803/281-421</b> Zásuvný modul; Pro základní svorky; 2pól.; S usměrňovací a LED diodou; Šířka 10 mm; Šedá	<a href="http://www.wago.com/280-803/281-421">www.wago.com/280-803/281-421</a>
	<b>Obj. č.: 721-162/003-000</b> Male connector for rail-mount terminal blocks; 1.2 x 1.2 mm pins; Rovné provedení; 100% ochrana proti chybnému zapojení; Rozteč 5 mm; 2pól.; Světle šedá	<a href="http://www.wago.com/721-162/003-000">www.wago.com/721-162/003-000</a>
	<b>Obj. č.: 721-163/003-000</b> Male connector for rail-mount terminal blocks; 1.2 x 1.2 mm pins; Rovné provedení; 100% ochrana proti chybnému zapojení; Rozteč 5 mm; 3pól.; Světle šedá	<a href="http://www.wago.com/721-163/003-000">www.wago.com/721-163/003-000</a>
	<b>Obj. č.: 721-164/003-000</b> Male connector for rail-mount terminal blocks; 1.2 x 1.2 mm pins; straight; 100% protected against mismatching; Pin spacing 5 mm; 4-pole; light gray	<a href="http://www.wago.com/721-164/003-000">www.wago.com/721-164/003-000</a>
	<b>Obj. č.: 721-165/003-000</b> Male connector for rail-mount terminal blocks; 1.2 x 1.2 mm pins; Rovné provedení; 100% ochrana proti chybnému zapojení; Rozteč 5 mm; 5pól.; Světle šedá	<a href="http://www.wago.com/721-165/003-000">www.wago.com/721-165/003-000</a>

	<b>Obj. č.: 721-166/003-000</b> Male connector for rail-mount terminal blocks; 1.2 x 1.2 mm pins; Rovné provedení; 100% ochrana proti chybnému zapojení; Rozteč 5 mm; 6pól.; Světle šedá	<a href="http://www.wago.com/721-166/003-000">www.wago.com/721-166/003-000</a>
	<b>Obj. č.: 721-167/003-000</b> Male connector for rail-mount terminal blocks; 1.2 x 1.2 mm pins; Rovné provedení; 100% ochrana proti chybnému zapojení; Rozteč 5 mm; 7pól.; Světle šedá	<a href="http://www.wago.com/721-167/003-000">www.wago.com/721-167/003-000</a>
	<b>Obj. č.: 721-168/003-000</b> Male connector for rail-mount terminal blocks; 1.2 x 1.2 mm pins; Rovné provedení; 100% ochrana proti chybnému zapojení; Rozteč 5 mm; 8pól.; Světle šedá	<a href="http://www.wago.com/721-168/003-000">www.wago.com/721-168/003-000</a>
	<b>Obj. č.: 721-169/003-000</b> Male connector for rail-mount terminal blocks; 1.2 x 1.2 mm pins; Rovné provedení; 100% ochrana proti chybnému zapojení; Rozteč 5 mm; 9pól.; Světle šedá	<a href="http://www.wago.com/721-169/003-000">www.wago.com/721-169/003-000</a>
	<b>Obj. č.: 721-170/003-000</b> Male connector for rail-mount terminal blocks; 1.2 x 1.2 mm pins; Rovné provedení; 100% ochrana proti chybnému zapojení; Rozteč 5 mm; 10pól.; Světle šedá	<a href="http://www.wago.com/721-170/003-000">www.wago.com/721-170/003-000</a>
	<b>Obj. č.: 721-171/003-000</b> Male connector for rail-mount terminal blocks; 1.2 x 1.2 mm pins; straight; 100% protected against mismatching; Pin spacing 5 mm; 11-pole; light gray	<a href="http://www.wago.com/721-171/003-000">www.wago.com/721-171/003-000</a>
	<b>Obj. č.: 721-172/003-000</b> Male connector for rail-mount terminal blocks; 1.2 x 1.2 mm pins; Rovné provedení; 100% ochrana proti chybnému zapojení; Rozteč 5 mm; 12pól.; Světle šedá	<a href="http://www.wago.com/721-172/003-000">www.wago.com/721-172/003-000</a>
	<b>Obj. č.: 721-173/003-000</b> Male connector for rail-mount terminal blocks; 1.2 x 1.2 mm pins; straight; 100% protected against mismatching; Pin spacing 5 mm; 13-pole; light gray	<a href="http://www.wago.com/721-173/003-000">www.wago.com/721-173/003-000</a>
	<b>Obj. č.: 721-174/003-000</b> Male connector for rail-mount terminal blocks; 1.2 x 1.2 mm pins; straight; 100% protected against mismatching; Pin spacing 5 mm; 14-pole; light gray	<a href="http://www.wago.com/721-174/003-000">www.wago.com/721-174/003-000</a>
	<b>Obj. č.: 721-175/003-000</b> Male connector for rail-mount terminal blocks; 1.2 x 1.2 mm pins; straight; 100% protected against mismatching; Pin spacing 5 mm; 15-pole; light gray	<a href="http://www.wago.com/721-175/003-000">www.wago.com/721-175/003-000</a>
	<b>Obj. č.: 721-176/003-000</b> Male connector for rail-mount terminal blocks; 1.2 x 1.2 mm pins; Rovné provedení; 100% ochrana proti chybnému zapojení; Rozteč 5 mm; 16pól.; Světle šedá	<a href="http://www.wago.com/721-176/003-000">www.wago.com/721-176/003-000</a>
	<b>Obj. č.: 721-180/003-000</b> Male connector for rail-mount terminal blocks; 1.2 x 1.2 mm pins; straight; 100% protected against mismatching; Pin spacing 5 mm; 20-pole; light gray	<a href="http://www.wago.com/721-180/003-000">www.wago.com/721-180/003-000</a>

**Ke stažení****Documentation****Additional Information**

Technical explanations

03-Apr-2019

pdf  
2,1 MB

Stáhnout



## CAD/CAE-Data

### CAD data

	URL	Stáhnout
2D/3D Models 280-901		

---

### CAE data

EPLAN Data Portal 280-901		Stáhnout
---------------------------	--	----------

---

WSCAD Universe 280-901		Stáhnout
------------------------	--	----------

---



## Handling Instructions

### Assembly

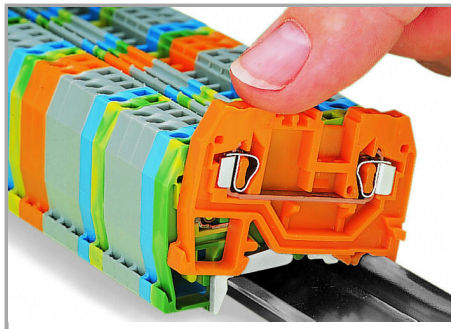

Snapping a terminal block onto the carrier rail.

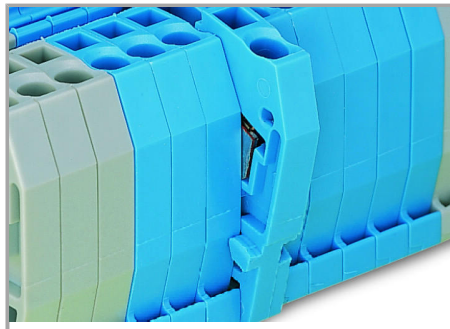

Quick assembly keys prevent reverse mounting.

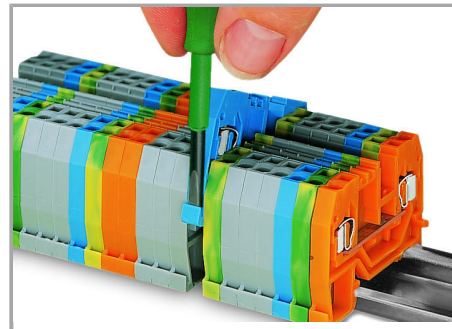

Removing a terminal block from the assembly.

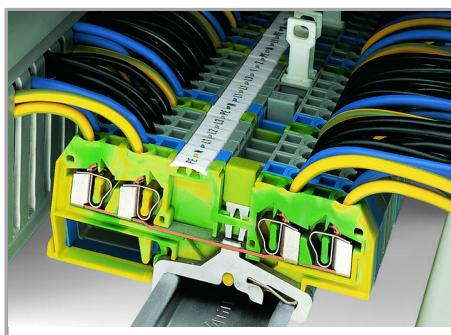

Steel carrier rails are not suited for PEN (ground and N-conductor) applications per EN 60947-7-2 (VDE 0611, Part 3).

### Inserting a conductor

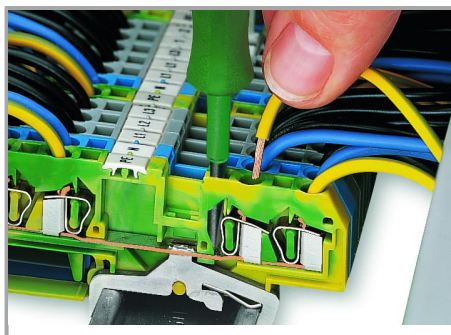

### CAGE CLAMP® connection

Změny vyhrazeny.

Inserting a conductor.  
WAGO Elektro spol. s r. o.  
Rozvodova 1116/36  
143 00 Praha 12 - Modřany  
Tel.: +420 261 090 143  
Email: [info.cz@wago.com](mailto:info.cz@wago.com), [wago-cz@wago.com](mailto:wago-cz@wago.com)

Máte otázky ohledně našich produktů?  
Kdykoli nám zavolejte na číslo +420 261 090 143.

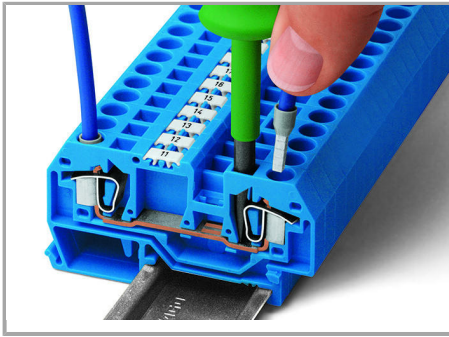

**CAGE CLAMP® connection**

Inserting a conductor.

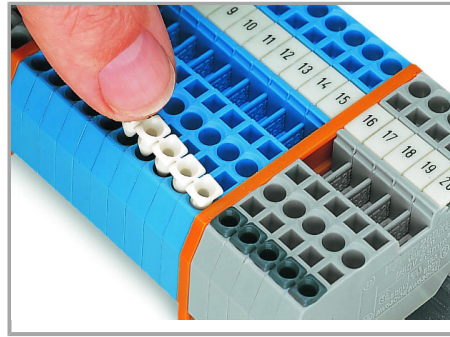

Inserting insulation stops.

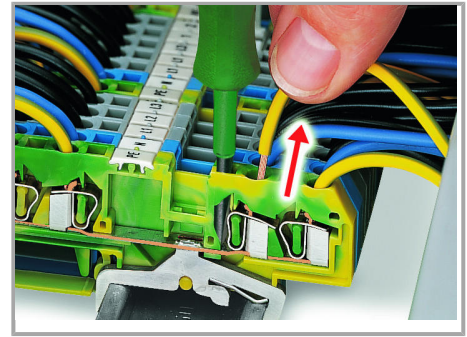

**CAGE CLAMP®-Anschluss**

Leiter lösen.

With ferruled conductors, it is necessary to use a terminal block one size larger than the conductor's nominal cross-section.

#### Jumpered

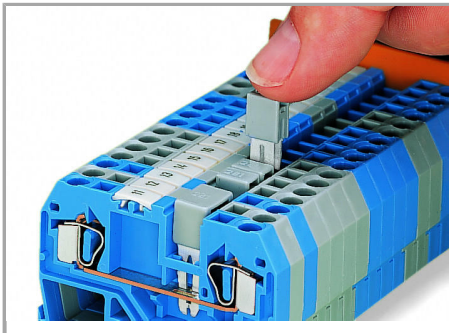

Commoning using an adjacent jumper (280-402).

Push jumper down until fully inserted.

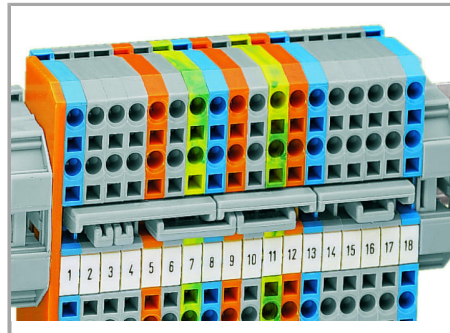

Staggered jumpers for sophisticated circuit requirements – push jumpers down until fully inserted.

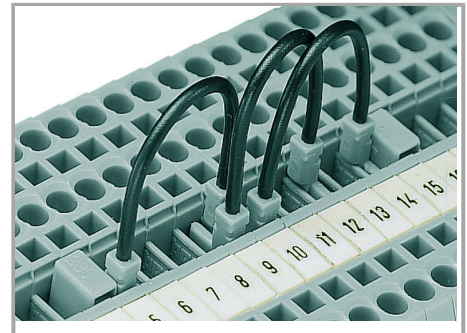

**Wire jumpers**

When installing machines or control systems, it is often necessary to make an additional connection between two terminal blocks that are not next to each other on the rail. In such cases, WAGO's touch-proof, push-in type wire jumpers are the ideal solution.

Změny vyhrazeny.

WAGO Elektro spol. sr. o.  
Rozvodova 1116/36  
143 00 Praha 12 - Modřany  
Tel.: +420 261 090 143  
Email: [info.cz@wago.com](mailto:info.cz@wago.com), [wago-cz@wago.com](mailto:wago-cz@wago.com)

Máte otázky ohledně našich produktů?  
Kdykoli nám zavolejte na číslo +420 261 090 143.

These jumpers are compatible with the following rail-mount terminal blocks:



- 279 Series (1.5 mm<sup>2</sup>/16 AWG),
- 
- 280/775/780 Series (2.5 mm<sup>2</sup>/14 AWG)
- 
- 281/769/776/777/781 and 880 Series (4 mm<sup>2</sup>/12 AWG)
- 

They are available in three conductor lengths (60, 110 and 250 mm), allowing up to 60 terminal blocks to be commoned depending on their width (see table on the right).

Compared with the 279 Series, the 280/775/780 and 281/776/777/781 Series can also accommodate two wire jumpers, allowing the use of commoning chains. Furthermore, the 280/769/775/780/880 and 281/776/777/781 Series allow both wire jumper and adjacent jumper to be simultaneously plugged into a same terminal block.

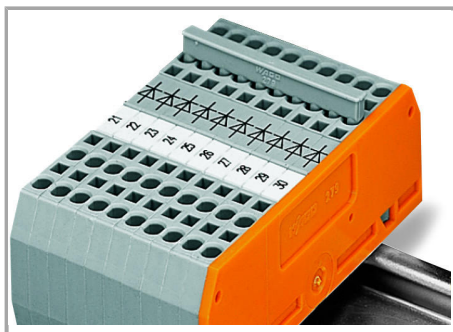

Brücken mit Brückungskämmen  
Brückungskämme bis zum Anschlag  
hinunterdrücken.

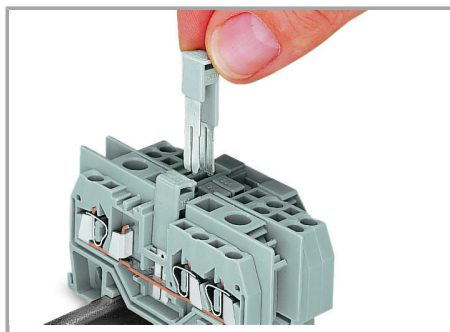

Commoning terminal blocks of different  
sizes via step-down jumpers.

Změny vyhrazeny.

WAGO Elektro spol. sr. o.  
Rozvodova 1116/36  
143 00 Praha 12 - Modřany  
Tel.: +420 261 090 143  
Email: [info.cz@wago.com](mailto:info.cz@wago.com), [wago-cz@wago.com](mailto:wago-cz@wago.com)

Máte otázky ohledně našich produktů?  
Kdykoli nám zavolejte na číslo +420 261 090 143.

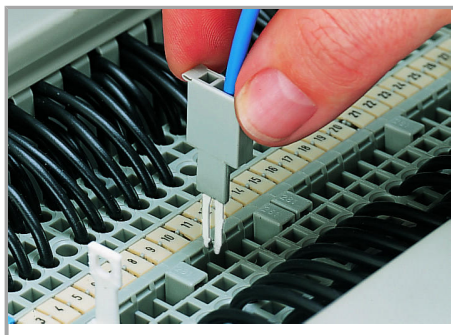

Testing with a test plug

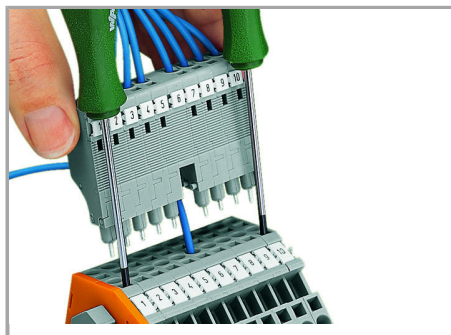

L-type test plug modules fitted with CAGE CLAMP®

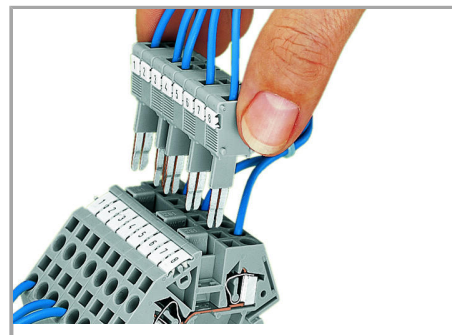

B-type test plug modules fitted with CAGE CLAMP®

(picture shows a test plug fitted with CAGE CLAMP®).

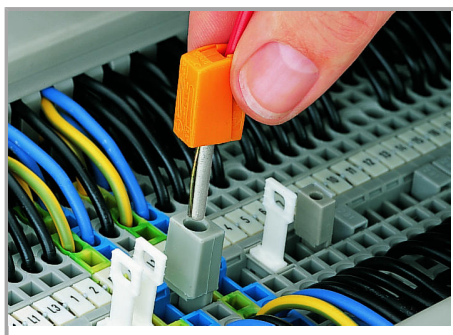

Testing with a test plug

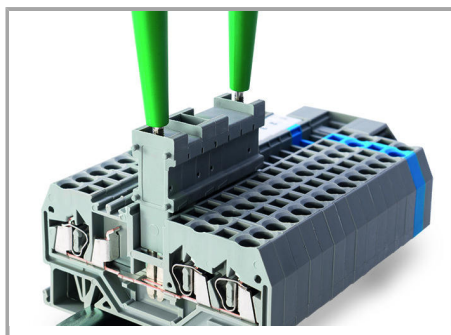

The test plug modules are directly plugged into the jumper contact slot of the current bar.

(picture shows 209-170 Test Plug Adapter).

#### Cover

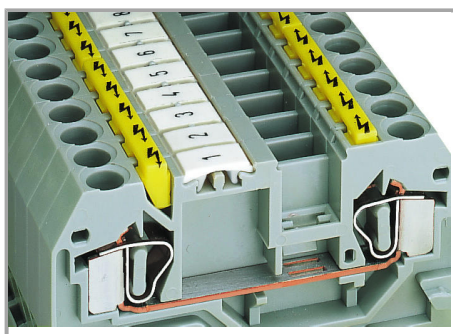

Protective warning markers inserted into the operating slots.  
Značky vloženy.

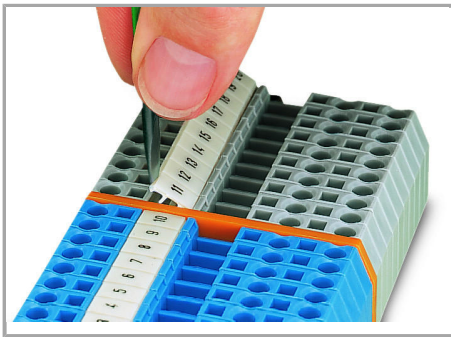

Marking via WMB Multi Marking System.

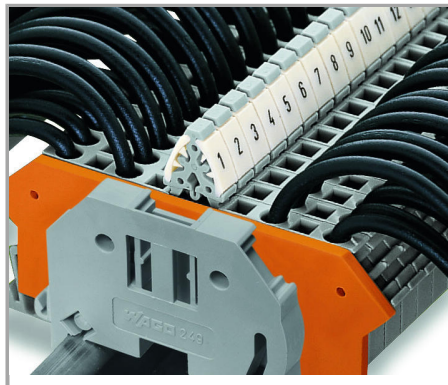

Terminal block marking with double marker carriers (209-128) for terminal blocks with side marking

Změny vyhrazeny.

WAGO Elektro spol. sr. o.  
Rozvodova 1116/36  
143 00 Praha 12 - Modřany  
Tel.: +420 261 090 143  
Email: [info.cz@wago.com](mailto:info.cz@wago.com), [wago-cz@wago.com](mailto:wago-cz@wago.com)

Máte otázky ohledně našich produktů?  
Kdykoli nám zavolejte na číslo +420 261 090 143.