

Datový list | Objednací číslo: 280-547

Třípatrová svorka; Svorka pro ochranný vodič / průchozí / průchozí svorka; S držákem popisu; Na DIN lištu 35 × 15 a 35 × 7,5; 2,5 mm<sup>2</sup>; CAGE CLAMP®; 2,50 mm<sup>2</sup>; Zelená – žlutá / modrá / šedá

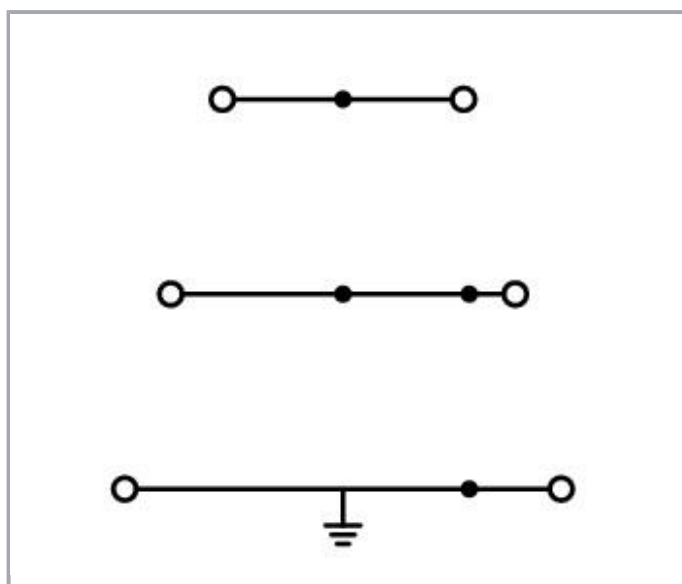

[www.wago.com/280-547](http://www.wago.com/280-547)

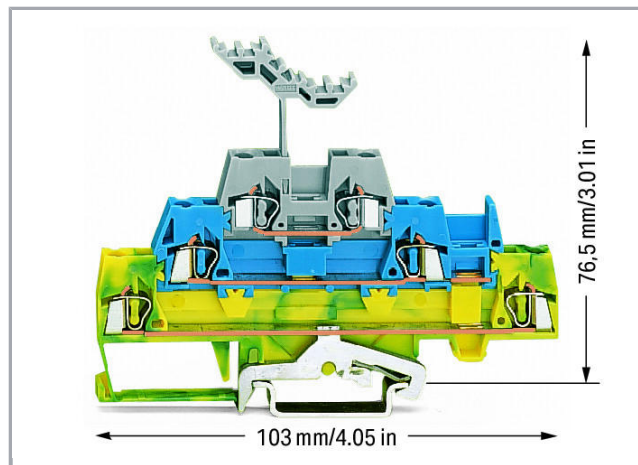
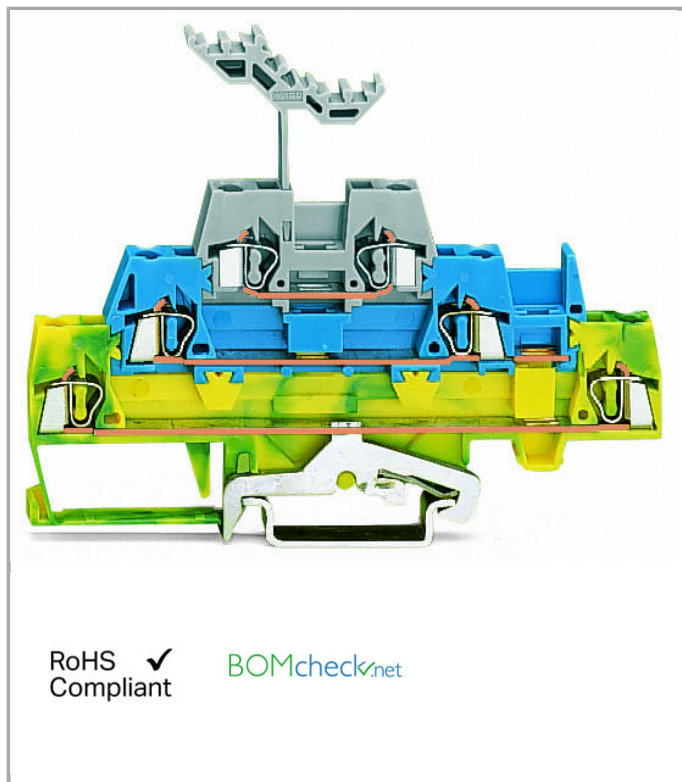

Popis položky

Upozornění:  
Terminating Aluminum Conductors



WAGO spring clamp terminal blocks are suitable for solid aluminum conductors up to 4 mm<sup>2</sup>/12 AWG if WAGO "Alu-Plus" Contact Paste is used for termination.

"Alu-Plus" Contact Paste Advantages:

- Automatically destroys the oxide film during clamping.
- Prevents fresh oxidation at the clamping point.
- Prevents electrolytic corrosion between aluminum and copper conductors (in the same terminal block).
- Provides long-term protection against corrosion.

Using terminal blocks with CAGE CLAMP® Spring Pressure Connection Technology, **aluminum conductors must first be cleaned with a blade and then immediately be inserted into the clamping units filled with "Alu-Plus" Contact Paste.**

It is also possible to apply WAGO "Alu-Plus" **additionally** on the whole surface of the aluminum conductor before termination.

Please note that the nominal currents must be adapted to the reduced conductivity of the aluminum conductors:

2.5 mm<sup>2</sup> (14 AWG) = 16 A

4 mm<sup>2</sup> (12 AWG) = 22 A

## Data

### Elektrické parametry

#### Ratings per IEC/EN 60664-1

Návrhové napětí (III / 3)	500 V
Návrhové rázové napětí (III / 3)	6 kV
Jmenovitý proud	20 A
Legenda (návrhové hodnoty)	(III / 3) ≙ kategorie přepětí III / stupeň znečištění 3

#### Údaje o připojení

Připojovací technika	CAGE CLAMP®
Způsob ovládání	Ovládací nástroj
Materiály připojitelných vodičů	Měď Hliník
Plný vodič	0,08 ... 2,5 mm <sup>2</sup> / 28 ... 12 AWG
Jemně laněný vodič	0,08 ... 2,5 mm <sup>2</sup> / 28 ... 12 AWG
Délka odizolování	8 ... 9 mm / 0.31 ... 0.35 palec
Celkový počet kontaktních míst	6
Celkový počet potenciálů	3
Počet úrovní	3
Způsob zapojení	čelní připojení
Upozornění (průřez vodiče)	12 AWG: THHN, THWN

## Geometrické údaje

Šířka	5 mm / 0.197 inch
Výška od horní hrany lišty DIN 35	76,5 mm / 3.012 inch
Hloubka	103 mm / 4.055 inch

## Mechanické parametry

Provedení	Horizontální provedení
Způsob montáže	Lišta DIN 35
Úroveň popisování	Středový popis

## Údaje o materiálu



barva	Zelená – žlutá / modrá / šedá
Izolační materiál	Polyamid 66 (PA 66)
Požární zatížení	0.279 MJ
Hmotnost	21.724 g

## Obchodní údaje

Product Group	1 (Rail Mounted Terminal Blocks)
Druh balení	BOX
Country of origin	CN
GTIN	4050821293712
Customs Tariff No.	85369010000

## Atesty/certifikáty

### Specifické atesty jednotlivých států

Logo	Schválení	Doplňkový text schválení	Název certifikátu
	CCA DEKRA Certification B.V.	EN 60947	2157201.01
	CSA DEKRA Certification B.V.	C22.2	1536071

### Atesty pro použití v lodním průmyslu

Logo	Schválení	Doplňkový text schválení	Název certifikátu
	ABS American Bureau of Shipping	EN 60947	14- HG1293677-



	<b>BV</b> Bureau Veritas S.A.	EN 60947	07436/E0 BV
---	----------------------------------	----------	-------------



	<b>DNV GL</b> Det Norske Veritas, Germanischer Lloyd	-	TAE00001V2
--	---	---	------------



	<b>LR</b> Lloyds Register	EN 60947	91/20112 (E9)
---	------------------------------	----------	------------------

## Atesty UL

Logo	Schválení	Doplňkový text schválení	Název certifikátu
	<b>UR</b> Underwriters Laboratories Inc.	UL 1059	20190731- E45172

## Kompatibilní produkty

## check



<b>Obj. č.: 249-141</b> Modul pro zkušební zástrčku L; Možnost řadového připojení; S pružnou kontaktní vidlicí; Středový modul; 1,50 mm <sup>2</sup> ; Šedá	<a href="http://www.wago.com/249-141">www.wago.com/249-141</a>
--	--

## assembling

































<b>Obj. č.: 209-106</b> Držák; K izolované montáži nosných lišt DIN 35; Šedá	<a href="http://www.wago.com/209-106">www.wago.com/209-106</a>
---	--



































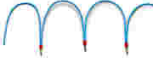



<b>Obj. č.: 709-154</b> Krycí profil; Typ 2; Vhodný pro držák krycího profilu typu 2; Délka 1 m; Transparentní	<a href="http://www.wago.com/709-154">www.wago.com/709-154</a>
---	--

## tools

	<b>Obj. č.: 210-657</b> Ovládací nástroj; Břit: 3,5 × 0,5 mm; S částečně izolovanou rukojetí; Krátké	<a href="http://www.wago.com/210-657">www.wago.com/210-657</a>
	<b>Obj. č.: 210-658</b> Ovládací nástroj; Břit: 3,5 × 0,5 mm; S částečně izolovanou rukojetí; Úhlové provedení; Krátké	<a href="http://www.wago.com/210-658">www.wago.com/210-658</a>
	<b>Obj. č.: 210-720</b> Ovládací nástroj; Břit: 3,5 × 0,5 mm; S částečně izolovanou rukojetí	<a href="http://www.wago.com/210-720">www.wago.com/210-720</a>
<b>General accessories</b>		
	<b>Obj. č.: 231-162/003-000</b> Male connector for rail-mount terminal blocks; 1.2 x 1.2 mm pins; Rovné provedení; Rozteč 5 mm; 2pól.; Šedá	<a href="http://www.wago.com/231-162/003-000">www.wago.com/231-162/003-000</a>
	<b>Obj. č.: 231-163/003-000</b> Male connector for rail-mount terminal blocks; 1.2 x 1.2 mm pins; Rovné provedení; Rozteč 5 mm; 3pól.; Šedá	<a href="http://www.wago.com/231-163/003-000">www.wago.com/231-163/003-000</a>
	<b>Obj. č.: 231-164/003-000</b> Male connector for rail-mount terminal blocks; 1.2 x 1.2 mm pins; Rovné provedení; Rozteč 5 mm; 4pól.; Šedá	<a href="http://www.wago.com/231-164/003-000">www.wago.com/231-164/003-000</a>
	<b>Obj. č.: 231-165/003-000</b> Male connector for rail-mount terminal blocks; 1.2 x 1.2 mm pins; Rovné provedení; Rozteč 5 mm; 5pól.; Šedá	<a href="http://www.wago.com/231-165/003-000">www.wago.com/231-165/003-000</a>
	<b>Obj. č.: 231-166/003-000</b> Male connector for rail-mount terminal blocks; 1.2 x 1.2 mm pins; Rovné provedení; Rozteč 5 mm; 6pól.; Šedá	<a href="http://www.wago.com/231-166/003-000">www.wago.com/231-166/003-000</a>
	<b>Obj. č.: 231-167/003-000</b> Male connector for rail-mount terminal blocks; 1.2 x 1.2 mm pins; Rovné provedení; Rozteč 5 mm; 7pól.; Šedá	<a href="http://www.wago.com/231-167/003-000">www.wago.com/231-167/003-000</a>
	<b>Obj. č.: 231-168/003-000</b> Male connector for rail-mount terminal blocks; 1.2 x 1.2 mm pins; Rovné provedení; Rozteč 5 mm; 8pól.; Šedá	<a href="http://www.wago.com/231-168/003-000">www.wago.com/231-168/003-000</a>
	<b>Obj. č.: 231-169/003-000</b> Male connector for rail-mount terminal blocks; 1.2 x 1.2 mm pins; Rovné provedení; Rozteč 5 mm; 9pól.; Šedá	<a href="http://www.wago.com/231-169/003-000">www.wago.com/231-169/003-000</a>
	<b>Obj. č.: 231-170/003-000</b> Male connector for rail-mount terminal blocks; 1.2 x 1.2 mm pins; Rovné provedení; Rozteč 5 mm; 10pól.; Šedá	<a href="http://www.wago.com/231-170/003-000">www.wago.com/231-170/003-000</a>
	<b>Obj. č.: 231-171/003-000</b> Male connector for rail-mount terminal blocks; 1.2 x 1.2 mm pins; Rovné provedení; Rozteč 5 mm; 11pól.; Šedá	<a href="http://www.wago.com/231-171/003-000">www.wago.com/231-171/003-000</a>
	<b>Obj. č.: 231-172/003-000</b> Male connector for rail-mount terminal blocks; 1.2 x 1.2 mm pins; Rovné provedení; Rozteč 5 mm; 12pól.; Šedá	<a href="http://www.wago.com/231-172/003-000">www.wago.com/231-172/003-000</a>
	<b>Obj. č.: 231-176/003-000</b> Male connector for rail-mount terminal blocks; 1.2 x 1.2 mm pins; Rovné provedení; Rozteč 5 mm; 16pól.; Šedá	<a href="http://www.wago.com/231-176/003-000">www.wago.com/231-176/003-000</a>

	<b>Obj. č.: 231-180/003-000</b> Male connector for rail-mount terminal blocks; 1.2 x 1.2 mm pins; Rovné provedení; Rozteč 5 mm; 2pól.; Šedá	<a href="http://www.wago.com/231-180/003-000">www.wago.com/231-180/003-000</a>
	<b>Obj. č.: 231-668</b> Zavírací kolíky; K uzavření nepotřebných kontaktních míst; Šedá	<a href="http://www.wago.com/231-668">www.wago.com/231-668</a>
	<b>Obj. č.: 231-669</b> Zavírací kolíky; K uzavření nepotřebných kontaktních míst; Oranžová	<a href="http://www.wago.com/231-669">www.wago.com/231-669</a>
	<b>Obj. č.: 721-162/003-000</b> Male connector for rail-mount terminal blocks; 1.2 x 1.2 mm pins; Rovné provedení; 100% ochrana proti chybnému zapojení; Rozteč 5 mm; 2pól.; Světle šedá	<a href="http://www.wago.com/721-162/003-000">www.wago.com/721-162/003-000</a>
	<b>Obj. č.: 721-163/003-000</b> Male connector for rail-mount terminal blocks; 1.2 x 1.2 mm pins; Rovné provedení; 100% ochrana proti chybnému zapojení; Rozteč 5 mm; 3pól.; Světle šedá	<a href="http://www.wago.com/721-163/003-000">www.wago.com/721-163/003-000</a>
	<b>Obj. č.: 721-164/003-000</b> Male connector for rail-mount terminal blocks; 1.2 x 1.2 mm pins; straight; 100% protected against mismatching; Pin spacing 5 mm; 4-pole; light gray	<a href="http://www.wago.com/721-164/003-000">www.wago.com/721-164/003-000</a>
	<b>Obj. č.: 721-165/003-000</b> Male connector for rail-mount terminal blocks; 1.2 x 1.2 mm pins; Rovné provedení; 100% ochrana proti chybnému zapojení; Rozteč 5 mm; 5pól.; Světle šedá	<a href="http://www.wago.com/721-165/003-000">www.wago.com/721-165/003-000</a>
	<b>Obj. č.: 721-166/003-000</b> Male connector for rail-mount terminal blocks; 1.2 x 1.2 mm pins; Rovné provedení; 100% ochrana proti chybnému zapojení; Rozteč 5 mm; 6pól.; Světle šedá	<a href="http://www.wago.com/721-166/003-000">www.wago.com/721-166/003-000</a>
	<b>Obj. č.: 721-167/003-000</b> Male connector for rail-mount terminal blocks; 1.2 x 1.2 mm pins; Rovné provedení; 100% ochrana proti chybnému zapojení; Rozteč 5 mm; 7pól.; Světle šedá	<a href="http://www.wago.com/721-167/003-000">www.wago.com/721-167/003-000</a>
	<b>Obj. č.: 721-168/003-000</b> Male connector for rail-mount terminal blocks; 1.2 x 1.2 mm pins; Rovné provedení; 100% ochrana proti chybnému zapojení; Rozteč 5 mm; 8pól.; Světle šedá	<a href="http://www.wago.com/721-168/003-000">www.wago.com/721-168/003-000</a>
	<b>Obj. č.: 721-169/003-000</b> Male connector for rail-mount terminal blocks; 1.2 x 1.2 mm pins; Rovné provedení; 100% ochrana proti chybnému zapojení; Rozteč 5 mm; 9pól.; Světle šedá	<a href="http://www.wago.com/721-169/003-000">www.wago.com/721-169/003-000</a>
	<b>Obj. č.: 721-170/003-000</b> Male connector for rail-mount terminal blocks; 1.2 x 1.2 mm pins; Rovné provedení; 100% ochrana proti chybnému zapojení; Rozteč 5 mm; 10pól.; Světle šedá	<a href="http://www.wago.com/721-170/003-000">www.wago.com/721-170/003-000</a>
	<b>Obj. č.: 721-171/003-000</b> Male connector for rail-mount terminal blocks; 1.2 x 1.2 mm pins; straight; 100% protected against mismatching; Pin spacing 5 mm; 11-pole; light gray	<a href="http://www.wago.com/721-171/003-000">www.wago.com/721-171/003-000</a>
	<b>Obj. č.: 721-172/003-000</b> Male connector for rail-mount terminal blocks; 1.2 x 1.2 mm pins; Rovné provedení; 100% ochrana proti chybnému zapojení; Rozteč 5 mm; 12pól.; Světle šedá	<a href="http://www.wago.com/721-172/003-000">www.wago.com/721-172/003-000</a>
	<b>Obj. č.: 721-173/003-000</b> Male connector for rail-mount terminal blocks; 1.2 x 1.2 mm pins; straight; 100% protected against mismatching; Pin spacing 5 mm; 13-pole; light gray	<a href="http://www.wago.com/721-173/003-000">www.wago.com/721-173/003-000</a>
	<b>Obj. č.: 721-174/003-000</b>	

	Male connector for rail-mount terminal blocks; 1.2 x 1.2 mm pins; straight; 100% protected against mismatching; Pin spacing 5 mm; 14-pole; light gray	<a href="http://www.wago.com/721-174/003-000">www.wago.com/721-174/003-000</a>
	<b>Obj. č.: 721-175/003-000</b> Male connector for rail-mount terminal blocks; 1.2 x 1.2 mm pins; straight; 100% protected against mismatching; Pin spacing 5 mm; 15-pole; light gray	<a href="http://www.wago.com/721-175/003-000">www.wago.com/721-175/003-000</a>
	<b>Obj. č.: 721-176/003-000</b> Male connector for rail-mount terminal blocks; 1.2 x 1.2 mm pins; Rovné provedení; 100% ochrana proti chybnému zapojení; Rozteč 5 mm; 16pól.; Světle šedá	<a href="http://www.wago.com/721-176/003-000">www.wago.com/721-176/003-000</a>
	<b>Obj. č.: 721-180/003-000</b> Male connector for rail-mount terminal blocks; 1.2 x 1.2 mm pins; straight; 100% protected against mismatching; Pin spacing 5 mm; 20-pole; light gray	<a href="http://www.wago.com/721-180/003-000">www.wago.com/721-180/003-000</a>
<b>Insulation stop</b>		
	<b>Obj. č.: 280-470</b> Izolační zarážka; 0,08–0,2 mm² „e“ (0,14 mm² „f“); 5 ks/pás; Bílá	<a href="http://www.wago.com/280-470">www.wago.com/280-470</a>
	<b>Obj. č.: 280-471</b> Izolační zarážka; 0,25–0,5 mm²; 5 ks/pás; Světle šedá	<a href="http://www.wago.com/280-471">www.wago.com/280-471</a>
	<b>Obj. č.: 280-472</b> Izolační zarážka; 0,75–1 mm²; 5 ks/pás	<a href="http://www.wago.com/280-472">www.wago.com/280-472</a>
<b>Protective Warning Marker</b>		
	<b>Obj. č.: 280-415</b> Výstražný kryt; S černým symbolem blesku; Pro 5 svorek; Žlutá	<a href="http://www.wago.com/280-415">www.wago.com/280-415</a>
<b>Carrier rail</b>		
	<b>Obj. č.: 210-112</b> Ocelová nosná lišta; 35 x 7,5 mm; Tloušťka 1 mm; Délka 2 m; Děrovaná; Dle normy EN 60715; Šířka otvorů 25 mm; vzdálenost mezi otvory 36 mm	<a href="http://www.wago.com/210-112">www.wago.com/210-112</a>
	<b>Obj. č.: 210-113</b> Ocelová nosná lišta; 35 x 7,5 mm; Tloušťka 1 mm; Délka 2 m; Neděrovaná; Dle normy EN 60715	<a href="http://www.wago.com/210-113">www.wago.com/210-113</a>
	<b>Obj. č.: 210-114</b> Ocelová nosná lišta; 35 x 15 mm; Tloušťka 1,5 mm; Délka 2 m; Neděrovaná; Podobné EN 60715	<a href="http://www.wago.com/210-114">www.wago.com/210-114</a>
	<b>Obj. č.: 210-115</b> Ocelová nosná lišta; 35 x 7,5 mm; Tloušťka 1 mm; Délka 2 m; Děrovaná; Dle normy EN 60715; Šířka otvorů 18 mm; vzdálenost mezi otvory 25 mm	<a href="http://www.wago.com/210-115">www.wago.com/210-115</a>
	<b>Obj. č.: 210-118</b> Ocelová nosná lišta; 35 x 15 mm; Tloušťka 2,3 mm; Délka 2 m; Neděrovaná; Dle normy EN 60715	<a href="http://www.wago.com/210-118">www.wago.com/210-118</a>
	<b>Obj. č.: 210-196</b> Hliníková nosná lišta; 35 x 8,2 mm; Tloušťka 1,6 mm; Délka 2 m; Neděrovaná; Podobné EN 60715; Stříbrná	<a href="http://www.wago.com/210-196">www.wago.com/210-196</a>
	<b>Obj. č.: 210-197</b> Ocelová nosná lišta; 35 x 15 mm; Tloušťka 1,5 mm; Délka 2 m; Děrovaná; Podobné EN 60715	<a href="http://www.wago.com/210-197">www.wago.com/210-197</a>
	<b>Obj. č.: 210-198</b> Měděná nosná lišta; 35 x 15 mm; Tloušťka 2,3 mm; Délka 2 m; Neděrovaná; Dle normy EN 60715; Měděná	<a href="http://www.wago.com/210-198">www.wago.com/210-198</a>
	<b>Obj. č.: 210-504</b> Ocelová nosná lišta; 35 x 7,5 mm; Tloušťka 1 mm; Délka 2 m; Děrovaná; Pásově zinkováno; Dle normy	<a href="http://www.wago.com/210-504">www.wago.com/210-504</a>

	EN 60715	
	<b>Obj. č.: 210-505</b> Ocelová nosná lišta; 35 × 7,5 mm; Tloušťka 1 mm; Délka 2 m; Neděrovaná; Pásově zinkováno; Dle normy EN 60715	<a href="http://www.wago.com/210-505">www.wago.com/210-505</a>
	<b>Obj. č.: 210-506</b> Ocelová nosná lišta; 35 × 15 mm; Tloušťka 1,5 mm; Délka 2 m; Neděrovaná; Pásově zinkováno; Podobné EN 60715	<a href="http://www.wago.com/210-506">www.wago.com/210-506</a>
	<b>Obj. č.: 210-508</b> Ocelová nosná lišta; 35 × 15 mm; Tloušťka 1,5 mm; Délka 2 m; Děrovaná; Pásově zinkováno; Podobné EN 60715	<a href="http://www.wago.com/210-508">www.wago.com/210-508</a>
<b>Jumper</b>		
	<b>Obj. č.: 210-103</b> Vícenásobný vodičový můstek; Izolováno; 50 přípojek; Černá	<a href="http://www.wago.com/210-103">www.wago.com/210-103</a>
	<b>Obj. č.: 210-123</b> Vícenásobný vodičový můstek; Izolováno; 50 přípojek	<a href="http://www.wago.com/210-123">www.wago.com/210-123</a>
	<b>Obj. č.: 249-123</b> Vodičový můstek; Izolováno; L = 180 mm; Průřez vedení 0,75 mm <sup>2</sup>	<a href="http://www.wago.com/249-123">www.wago.com/249-123</a>
	<b>Obj. č.: 249-125</b> Vodičový můstek; Izolováno; L = 60 mm; Průřez vedení 0,75 mm <sup>2</sup>	<a href="http://www.wago.com/249-125">www.wago.com/249-125</a>
	<b>Obj. č.: 249-126</b> Vodičový můstek; Izolováno; L = 110 mm; Průřez vedení 0,75 mm <sup>2</sup>	<a href="http://www.wago.com/249-126">www.wago.com/249-126</a>
	<b>Obj. č.: 249-127</b> Vodičový můstek; Izolováno; L = 250 mm; Průřez vedení 0,75 mm <sup>2</sup>	<a href="http://www.wago.com/249-127">www.wago.com/249-127</a>
	<b>Obj. č.: 280-402</b> Příčný můstek; Izolováno; IN = IN svorky; Šedá	<a href="http://www.wago.com/280-402">www.wago.com/280-402</a>
	<b>Obj. č.: 280-409</b> Příčný můstek ob svorku; Izolováno; IN = IN svorky; Šedá	<a href="http://www.wago.com/280-409">www.wago.com/280-409</a>
	<b>Obj. č.: 280-482</b> Hřebenový můstek; Izolováno; 2×; IN = IN svorky; Šedá	<a href="http://www.wago.com/280-482">www.wago.com/280-482</a>
	<b>Obj. č.: 280-483</b> Hřebenový můstek; Izolováno; 3×; IN = IN svorky; Šedá	<a href="http://www.wago.com/280-483">www.wago.com/280-483</a>
	<b>Obj. č.: 280-484</b> Hřebenový můstek; Izolováno; 4×; IN = IN svorky; Šedá	<a href="http://www.wago.com/280-484">www.wago.com/280-484</a>
	<b>Obj. č.: 280-485</b> Hřebenový můstek; Izolováno; 5×; IN = IN svorky; Šedá	<a href="http://www.wago.com/280-485">www.wago.com/280-485</a>
	<b>Obj. č.: 280-490</b> Hřebenový můstek; Izolováno; 10×; IN = IN svorky; Šedá	<a href="http://www.wago.com/280-490">www.wago.com/280-490</a>
	<b>Obj. č.: 280-492</b> Hřebenový můstek ob svorku; Izolováno; 2×; IN = IN svorky; Šedá	<a href="http://www.wago.com/280-492">www.wago.com/280-492</a>
	<b>Obj. č.: 281-421</b> Vertikální můstek; Izolováno; Jmenovitý proud 24 A; Šedá	<a href="http://www.wago.com/281-421">www.wago.com/281-421</a>





**Obj. č.: 709-110**  
Vícenásobný vodičový můstek; Izolováno; 4 přípojky; 3 × 110 mm; Černá

[www.wago.com/709-110](http://www.wago.com/709-110)



**Obj. č.: 709-111**  
Vícenásobný vodičový můstek; Izolováno; 3 přípojek; 2 × 120 mm; Černá

[www.wago.com/709-111](http://www.wago.com/709-111)



**Obj. č.: 709-112**  
Vícenásobný vodičový můstek; Izolováno; 3 přípojek; 2 × 170 mm; Černá

[www.wago.com/709-112](http://www.wago.com/709-112)



**Obj. č.: 780-452**  
Stupňovitý můstek; Izolováno; Z 1 na 2; Rozteč 5 mm; Vhodný pro 2vodičové pružinové svorkovnice; Šedá

[www.wago.com/780-452](http://www.wago.com/780-452)



**Obj. č.: 780-453**  
Stupňovitý můstek; Izolováno; z 1 na 3; Rozteč 5 mm; Vhodný pro 2vodičové pružinové svorkovnice; Šedá

[www.wago.com/780-453](http://www.wago.com/780-453)



**Obj. č.: 780-454**  
Stupňovitý můstek; Izolováno; Z 1 na 4; Rozteč 5 mm; Vhodný pro 2vodičové pružinové svorkovnice; Šedá

[www.wago.com/780-454](http://www.wago.com/780-454)



**Obj. č.: 780-455**  
Stupňovitý můstek; Izolováno; Z 1 na 5; Rozteč 5 mm; Vhodný pro 2vodičové pružinové svorkovnice; Šedá

[www.wago.com/780-455](http://www.wago.com/780-455)



**Obj. č.: 780-456**  
Stupňovitý můstek; Izolováno; Z 1 na 6; Rozteč 5 mm; Vhodný pro 2vodičové pružinové svorkovnice; Šedá

[www.wago.com/780-456](http://www.wago.com/780-456)



**Obj. č.: 780-457**  
Stupňovitý můstek; Izolováno; Z 1 na 7; Rozteč 5 mm; Vhodný pro 2vodičové pružinové svorkovnice; Šedá

[www.wago.com/780-457](http://www.wago.com/780-457)



**Obj. č.: 780-458**  
Stupňovitý můstek; Izolováno; Z 1 na 8; Rozteč 5 mm; Vhodný pro 2vodičové pružinové svorkovnice; Šedá

[www.wago.com/780-458](http://www.wago.com/780-458)

#### Marking accessories



**Obj. č.: 2009-115**  
WMB Inline; Pro Smart Printer; Na cívce; Flexibilní, 5–5,2 mm; Bez potisku; Možnost naklapnutí; Bílá

[www.wago.com/2009-115](http://www.wago.com/2009-115)



**Obj. č.: 2009-115/000-002**  
WMB Inline; Pro Smart Printer; Na cívce; Flexibilní, 5–5,2 mm; Bez potisku; Možnost naklapnutí; Žlutá

[www.wago.com/2009-115/000-002](http://www.wago.com/2009-115/000-002)



**Obj. č.: 2009-115/000-006**  
WMB Inline; Pro Smart Printer; Na cívce; Flexibilní, 5–5,2 mm; Bez potisku; Možnost naklapnutí; Modrá

[www.wago.com/2009-115/000-006](http://www.wago.com/2009-115/000-006)



**Obj. č.: 2009-115/000-007**  
WMB Inline; Pro Smart Printer; Na cívce; Flexibilní, 5–5,2 mm; Bez potisku; Možnost naklapnutí; Šedá

[www.wago.com/2009-115/000-007](http://www.wago.com/2009-115/000-007)

















**Obj. č.: 2009-115/000-012**  
WMB Inline; Pro Smart Printer; Na cívce; Flexibilní, 5–5,2 mm; Bez potisku; Možnost naklapnutí; Oranžová

[www.wago.com/2009-115/000-012](http://www.wago.com/2009-115/000-012)



**Obj. č.: 2009-115/000-017**  
WMB Inline; Pro Smart Printer; Na cívce; Flexibilní, 5–5,2 mm; Bez potisku; Možnost naklapnutí; Světle zelená

[www.wago.com/2009-115/000-017](http://www.wago.com/2009-115/000-017)

	<p><b>Obj. č.: 2009-115/000-023</b>                      WMB Inline; Pro Smart Printer; Na cívce; Flexibilní, 5–5,2 mm; Bez potisku; Možnost naklapnutí; Zelená</p>	<a href="http://www.wago.com/2009-115/000-023">www.wago.com/2009-115/000-023</a>
	<p><b>Obj. č.: 2009-115/000-024</b>                      WMB Inline; Pro Smart Printer; Na cívce; Flexibilní, 5–5,2 mm; Bez potisku; Možnost naklapnutí; Fialová</p>	<a href="http://www.wago.com/2009-115/000-024">www.wago.com/2009-115/000-024</a>
	<p><b>Obj. č.: 793-501</b>                      Popisovací karta WMB; Jako karta; Neflexibilní; Bez potisku; Možnost naklapnutí; Bílá</p>	<a href="http://www.wago.com/793-501">www.wago.com/793-501</a>
	<p><b>Obj. č.: 793-501/000-002</b>                      Popisovací karta WMB; Jako karta; Neflexibilní; Bez potisku; Možnost naklapnutí; Bílá</p>	<a href="http://www.wago.com/793-501/000-002">www.wago.com/793-501/000-002</a>
	<p><b>Obj. č.: 793-501/000-005</b>                      Popisovací karta WMB; Jako karta; Neflexibilní; Bez potisku; Možnost naklapnutí; Červená</p>	<a href="http://www.wago.com/793-501/000-005">www.wago.com/793-501/000-005</a>
	<p><b>Obj. č.: 793-501/000-006</b>                      Popisovací karta WMB; Jako karta; Neflexibilní; Bez potisku; Možnost naklapnutí; Modrá</p>	<a href="http://www.wago.com/793-501/000-006">www.wago.com/793-501/000-006</a>
	<p><b>Obj. č.: 793-501/000-007</b>                      Popisovací karta WMB; Jako karta; Neflexibilní; Bez potisku; Možnost naklapnutí; Šedá</p>	<a href="http://www.wago.com/793-501/000-007">www.wago.com/793-501/000-007</a>
	<p><b>Obj. č.: 793-501/000-012</b>                      Popisovací karta WMB; Jako karta; Neflexibilní; Bez potisku; Možnost naklapnutí; Oranžová</p>	<a href="http://www.wago.com/793-501/000-012">www.wago.com/793-501/000-012</a>
	<p><b>Obj. č.: 793-501/000-017</b>                      Popisovací karta WMB; Jako karta; Neflexibilní; Bez potisku; Možnost naklapnutí; Světle zelená</p>	<a href="http://www.wago.com/793-501/000-017">www.wago.com/793-501/000-017</a>
	<p><b>Obj. č.: 793-501/000-023</b>                      Popisovací karta WMB; Jako karta; Neflexibilní; Bez potisku; Možnost naklapnutí; Zelená</p>	<a href="http://www.wago.com/793-501/000-023">www.wago.com/793-501/000-023</a>
	<p><b>Obj. č.: 793-501/000-024</b>                      Popisovací karta WMB; Jako karta; Neflexibilní; Bez potisku; Možnost naklapnutí; Fialová</p>	<a href="http://www.wago.com/793-501/000-024">www.wago.com/793-501/000-024</a>
	<p><b>Obj. č.: 793-5501</b>                      Popisovací karta WMB; Jako karta; Pro svorky o šířce 5–17,5 mm; Flexibilní, 5–5,2 mm; Bez potisku; Možnost naklapnutí; Bílá</p>	<a href="http://www.wago.com/793-5501">www.wago.com/793-5501</a>
	<p><b>Obj. č.: 793-5501/000-002</b>                      Popisovací karta WMB; Jako karta; Pro svorky o šířce 5–17,5 mm; Flexibilní, 5–5,2 mm; Bez potisku; Možnost naklapnutí; Žlutá</p>	<a href="http://www.wago.com/793-5501/000-002">www.wago.com/793-5501/000-002</a>
	<p><b>Obj. č.: 793-5501/000-005</b>                      Popisovací karta WMB; Jako karta; Flexibilní, 5–5,2 mm; Bez potisku; Možnost naklapnutí; Červená</p>	<a href="http://www.wago.com/793-5501/000-005">www.wago.com/793-5501/000-005</a>
	<p><b>Obj. č.: 793-5501/000-006</b>                      Popisovací karta WMB; Jako karta; Flexibilní, 5–5,2 mm; Bez potisku; Možnost naklapnutí; Modrá</p>	<a href="http://www.wago.com/793-5501/000-006">www.wago.com/793-5501/000-006</a>



Obj. č.: 793-5501/000-007

Popisovací karta WMB; Jako karta; Flexibilní, 5–5,2 mm; Bez potisku; Možnost naklapnutí; Šedá

[www.wago.com/793-5501/000-007](http://www.wago.com/793-5501/000-007)

Obj. č.: 793-5501/000-012

Popisovací karta WMB; Jako karta; Flexibilní, 5–5,2 mm; Bez potisku; Možnost naklapnutí; Oranžová

[www.wago.com/793-5501/000-012](http://www.wago.com/793-5501/000-012)

Obj. č.: 793-5501/000-017

Popisovací karta WMB; Jako karta; Flexibilní, 5–5,2 mm; Bez potisku; Možnost naklapnutí; Světle zelená

[www.wago.com/793-5501/000-017](http://www.wago.com/793-5501/000-017)

Obj. č.: 793-5501/000-023

Popisovací karta WMB; Jako karta; Flexibilní, 5–5,2 mm; Bez potisku; Možnost naklapnutí; Zelená

[www.wago.com/793-5501/000-023](http://www.wago.com/793-5501/000-023)

Obj. č.: 793-5501/000-024

Popisovací karta WMB; Jako karta; Flexibilní, 5–5,2 mm; Bez potisku; Možnost naklapnutí; Fialová

[www.wago.com/793-5501/000-024](http://www.wago.com/793-5501/000-024)

## ferrule



Obj. č.: 216-101

Dutinka; Objímka na 0,5 mm<sup>2</sup> / AWG 22; Bez plastového límce; Galvanicky pocínováno[www.wago.com/216-101](http://www.wago.com/216-101)

Obj. č.: 216-102

Dutinka; Objímka na 0,75 mm<sup>2</sup> / AWG 20; Bez plastového límce; Galvanicky pocínováno[www.wago.com/216-102](http://www.wago.com/216-102)

Obj. č.: 216-103

Dutinka; Objímka na 1 mm<sup>2</sup> / AWG 18; Bez plastového límce; Galvanicky pocínováno[www.wago.com/216-103](http://www.wago.com/216-103)

Obj. č.: 216-104

Dutinka; Objímka na 1,5 mm<sup>2</sup> / AWG 16; Bez plastového límce; Galvanicky pocínováno[www.wago.com/216-104](http://www.wago.com/216-104)

Obj. č.: 216-201

Ferrule; Sleeve for 0.5 mm<sup>2</sup> / 20 AWG; insulated; electro-tin plated; white[www.wago.com/216-201](http://www.wago.com/216-201)

Obj. č.: 216-202

Ferrule; Sleeve for 0.75 mm<sup>2</sup> / 18 AWG; insulated; electro-tin plated; gray[www.wago.com/216-202](http://www.wago.com/216-202)

Obj. č.: 216-203

Dutinka; Objímka na 1 mm<sup>2</sup> / AWG 18; S plastovým límcem; Galvanicky pocínováno; Červená[www.wago.com/216-203](http://www.wago.com/216-203)

Obj. č.: 216-204

Dutinka; Objímka na 1,5 mm<sup>2</sup> / AWG 16; S plastovým límcem; Galvanicky pocínováno; Černá[www.wago.com/216-204](http://www.wago.com/216-204)

Obj. č.: 216-301

Dutinka; Objímka na 0,25 mm<sup>2</sup> / AWG 24; S plastovým límcem; Galvanicky pocínováno; Žlutá[www.wago.com/216-301](http://www.wago.com/216-301)

Obj. č.: 216-302

Ferrule; Sleeve for 0.34 mm<sup>2</sup> / 22 AWG; insulated; electro-tin plated; green[www.wago.com/216-302](http://www.wago.com/216-302)

## End plate



Obj. č.: 280-303

Koncová bočnice a separátor; Tloušťka 2,5 mm; Šedá

[www.wago.com/280-303](http://www.wago.com/280-303)

Obj. č.: 280-304

Koncová bočnice a separátor; Tloušťka 2,5 mm; Oranžová

[www.wago.com/280-304](http://www.wago.com/280-304)













Obj. č.: 280-336

















Oddělující deska; Tloušťka 1,1 mm; Oranžová

[www.wago.com/280-336](http://www.wago.com/280-336)

## Female plug

	<b>Obj. č.: 232-132/005-000</b> Female connector for rail-mount terminal blocks; Rovné provedení; Rozteč 5 mm; 2pól.; Šedá	<a href="http://www.wago.com/232-132/005-000">www.wago.com/232-132/005-000</a>
	<b>Obj. č.: 232-132/005-000/039-000</b> Female connector for rail-mount terminal blocks; straight; Locking lever; Pin spacing 5 mm; 3-pole; gray	<a href="http://www.wago.com/232-132/005-000/039-000">www.wago.com/232-132/005-000/039-000</a>
	<b>Obj. č.: 232-133/005-000</b> Female connector for rail-mount terminal blocks; Rovné provedení; Rozteč 5 mm; 3pól.; Šedá	<a href="http://www.wago.com/232-133/005-000">www.wago.com/232-133/005-000</a>
	<b>Obj. č.: 232-133/005-000/039-000</b> Female connector for rail-mount terminal blocks; Rovné provedení; Blokovací západka; Rozteč 5 mm; 3pól.; Šedá	<a href="http://www.wago.com/232-133/005-000/039-000">www.wago.com/232-133/005-000/039-000</a>
	<b>Obj. č.: 232-134/005-000</b> Female connector for rail-mount terminal blocks; Rovné provedení; Rozteč 5 mm; 4pól.; Šedá	<a href="http://www.wago.com/232-134/005-000">www.wago.com/232-134/005-000</a>
	<b>Obj. č.: 232-134/005-000/039-000</b> Female connector for rail-mount terminal blocks; Rovné provedení; Blokovací západka; Rozteč 5 mm; 4pól.; Šedá	<a href="http://www.wago.com/232-134/005-000/039-000">www.wago.com/232-134/005-000/039-000</a>
	<b>Obj. č.: 232-135/005-000</b> Female connector for rail-mount terminal blocks; Rovné provedení; Rozteč 5 mm; 5pól.; Šedá	<a href="http://www.wago.com/232-135/005-000">www.wago.com/232-135/005-000</a>
	<b>Obj. č.: 232-135/005-000/039-000</b> Female connector for rail-mount terminal blocks; Rovné provedení; Blokovací západka; Rozteč 5 mm; 5pól.; Šedá	<a href="http://www.wago.com/232-135/005-000/039-000">www.wago.com/232-135/005-000/039-000</a>
	<b>Obj. č.: 232-136/005-000</b> Female connector for rail-mount terminal blocks; Rovné provedení; Rozteč 5 mm; 6pól.; Šedá	<a href="http://www.wago.com/232-136/005-000">www.wago.com/232-136/005-000</a>
	<b>Obj. č.: 232-136/005-000/039-000</b> Female connector for rail-mount terminal blocks; Rovné provedení; Blokovací západka; Rozteč 5 mm; 6pól.; Šedá	<a href="http://www.wago.com/232-136/005-000/039-000">www.wago.com/232-136/005-000/039-000</a>
	<b>Obj. č.: 232-137/005-000</b> Female connector for rail-mount terminal blocks; Rovné provedení; Rozteč 5 mm; 7pól.; Šedá	<a href="http://www.wago.com/232-137/005-000">www.wago.com/232-137/005-000</a>
	<b>Obj. č.: 232-137/005-000/039-000</b> Female connector for rail-mount terminal blocks; Rovné provedení; Blokovací západka; Rozteč 5 mm; 7pól.; Šedá	<a href="http://www.wago.com/232-137/005-000/039-000">www.wago.com/232-137/005-000/039-000</a>
	<b>Obj. č.: 232-138/005-000</b> Female connector for rail-mount terminal blocks; Rovné provedení; Rozteč 5 mm; 8pól.; Šedá	<a href="http://www.wago.com/232-138/005-000">www.wago.com/232-138/005-000</a>
	<b>Obj. č.: 232-138/005-000/039-000</b> Female connector for rail-mount terminal blocks; Rovné provedení; Blokovací západka; Rozteč 5 mm;	

	8pól.; Šedá	<a href="http://www.wago.com/232-138/005-000/039-000">www.wago.com/232-138/005-000/039-000</a>
	<b>Obj. č.: 232-139/005-000</b> Female connector for rail-mount terminal blocks; Rovné provedení; Rozteč 5 mm; 9pól.; Šedá	<a href="http://www.wago.com/232-139/005-000">www.wago.com/232-139/005-000</a>
	<b>Obj. č.: 232-139/005-000/039-000</b> Female connector for rail-mount terminal blocks; Rovné provedení; Blokovací západka; Rozteč 5 mm; 9pól.; Šedá	<a href="http://www.wago.com/232-139/005-000/039-000">www.wago.com/232-139/005-000/039-000</a>
	<b>Obj. č.: 232-140/005-000</b> Female connector for rail-mount terminal blocks; Rovné provedení; Rozteč 5 mm; 10pól.; Šedá	<a href="http://www.wago.com/232-140/005-000">www.wago.com/232-140/005-000</a>
	<b>Obj. č.: 232-140/005-000/039-000</b> Female connector for rail-mount terminal blocks; Rovné provedení; Blokovací západka; Rozteč 5 mm; 10pól.; Šedá	<a href="http://www.wago.com/232-140/005-000/039-000">www.wago.com/232-140/005-000/039-000</a>
	<b>Obj. č.: 232-142/005-000</b> Female connector for rail-mount terminal blocks; Rovné provedení; Rozteč 5 mm; 12pól.; Šedá	<a href="http://www.wago.com/232-142/005-000">www.wago.com/232-142/005-000</a>
	<b>Obj. č.: 232-142/005-000/039-000</b> Female connector for rail-mount terminal blocks; Rovné provedení; Blokovací západka; Rozteč 5 mm; 12pól.; Šedá	<a href="http://www.wago.com/232-142/005-000/039-000">www.wago.com/232-142/005-000/039-000</a>
	<b>Obj. č.: 232-146/005-000</b> Female connector for rail-mount terminal blocks; Rovné provedení; Rozteč 5 mm; 16pól.; Šedá	<a href="http://www.wago.com/232-146/005-000">www.wago.com/232-146/005-000</a>
	<b>Obj. č.: 232-146/005-000/039-000</b> Female connector for rail-mount terminal blocks; Rovné provedení; Blokovací západka; Rozteč 5 mm; 16pól.; Šedá	<a href="http://www.wago.com/232-146/005-000/039-000">www.wago.com/232-146/005-000/039-000</a>
	<b>Obj. č.: 232-147/005-000/039-000</b> Female connector for rail-mount terminal blocks; straight; Locking lever; Pin spacing 5 mm; 17-pole; gray	<a href="http://www.wago.com/232-147/005-000/039-000">www.wago.com/232-147/005-000/039-000</a>
	<b>Obj. č.: 232-150/005-000</b> Female connector for rail-mount terminal blocks; Rovné provedení; Rozteč 5 mm; 20pól.; Šedá	<a href="http://www.wago.com/232-150/005-000">www.wago.com/232-150/005-000</a>
	<b>Obj. č.: 232-150/005-000/039-000</b> Female connector for rail-mount terminal blocks; straight; Locking lever; Pin spacing 5 mm; 20-pole; gray	<a href="http://www.wago.com/232-150/005-000/039-000">www.wago.com/232-150/005-000/039-000</a>
	<b>Obj. č.: 232-232/005-000</b> Female connector for rail-mount terminal blocks; Úhlové provedení; Rozteč 5 mm; 2pól.; Šedá	<a href="http://www.wago.com/232-232/005-000">www.wago.com/232-232/005-000</a>
	<b>Obj. č.: 232-232/005-000/039-000</b> Female connector for rail-mount terminal blocks; Úhlové provedení; Blokovací západka; Rozteč 5 mm; 2pól.; Šedá	<a href="http://www.wago.com/232-232/005-000/039-000">www.wago.com/232-232/005-000/039-000</a>
	<b>Obj. č.: 232-233/005-000</b> Female connector for rail-mount terminal blocks; Úhlové provedení; Rozteč 5 mm; 3pól.; Šedá	<a href="http://www.wago.com/232-233/005-000">www.wago.com/232-233/005-000</a>

**Obj. č.: 232-233/005-000/039-000**

Female connector for rail-mount terminal blocks; angled; Locking lever; Pin spacing 5 mm; 3-pole; gray

[www.wago.com/232-233/005-000/039-000](http://www.wago.com/232-233/005-000/039-000)**Obj. č.: 232-234/005-000**

Female connector for rail-mount terminal blocks; Úhlové provedení; Rozteč 5 mm; 4pól.; Šedá

[www.wago.com/232-234/005-000](http://www.wago.com/232-234/005-000)**Obj. č.: 232-234/005-000/039-000**

Female connector for rail-mount terminal blocks; Úhlové provedení; Blokovací západka; Rozteč 5 mm; 4pól.; Šedá

[www.wago.com/232-234/005-000/039-000](http://www.wago.com/232-234/005-000/039-000)**Obj. č.: 232-235/005-000**

Female connector for rail-mount terminal blocks; Úhlové provedení; Rozteč 5 mm; 5pól.; Šedá

[www.wago.com/232-235/005-000](http://www.wago.com/232-235/005-000)**Obj. č.: 232-235/005-000/039-000**

Female connector for rail-mount terminal blocks; Úhlové provedení; Blokovací západka; Rozteč 5 mm; 5pól.; Šedá

[www.wago.com/232-235/005-000/039-000](http://www.wago.com/232-235/005-000/039-000)**Obj. č.: 232-236/005-000**

Female connector for rail-mount terminal blocks; Úhlové provedení; Rozteč 5 mm; 6pól.; Šedá

[www.wago.com/232-236/005-000](http://www.wago.com/232-236/005-000)**Obj. č.: 232-236/005-000/039-000**

Female connector for rail-mount terminal blocks; angled; Locking lever; Pin spacing 5 mm; 6-pole; gray

[www.wago.com/232-236/005-000/039-000](http://www.wago.com/232-236/005-000/039-000)**Obj. č.: 232-237/005-000**

Female connector for rail-mount terminal blocks; Úhlové provedení; Rozteč 5 mm; 7pól.; Šedá

[www.wago.com/232-237/005-000](http://www.wago.com/232-237/005-000)**Obj. č.: 232-238/005-000**

Female connector for rail-mount terminal blocks; Úhlové provedení; Rozteč 5 mm; 8pól.; Šedá

[www.wago.com/232-238/005-000](http://www.wago.com/232-238/005-000)**Obj. č.: 232-239/005-000**

Female connector for rail-mount terminal blocks; Úhlové provedení; Rozteč 5 mm; 9pól.; Šedá

[www.wago.com/232-239/005-000](http://www.wago.com/232-239/005-000)**Obj. č.: 232-240/005-000**

Female connector for rail-mount terminal blocks; Úhlové provedení; Rozteč 5 mm; 10pól.; Šedá

[www.wago.com/232-240/005-000](http://www.wago.com/232-240/005-000)**Obj. č.: 232-240/005-000/039-000**

Female connector for rail-mount terminal blocks; Úhlové provedení; Blokovací západka; Rozteč 5 mm; 10pól.; Šedá















[www.wago.com/232-240/005-000/039-000](http://www.wago.com/232-240/005-000/039-000)**Obj. č.: 232-242/005-000**

Female connector for rail-mount terminal blocks; Úhlové provedení; Rozteč 5 mm; 12pól.; Šedá















[www.wago.com/232-242/005-000](http://www.wago.com/232-242/005-000)**Obj. č.: 232-242/005-000/039-000**

Female connector for rail-mount terminal blocks; Úhlové provedení; Blokovací západka; Rozteč 5 mm; 12pól.; Šedá















[www.wago.com/232-242/005-000/039-000](http://www.wago.com/232-242/005-000/039-000)















	<b>Obj. č.: 232-246/005-000</b> Female connector for rail-mount terminal blocks; Úhlové provedení; Rozteč 5 mm; 16pól.; Šedá	<a href="http://www.wago.com/232-246/005-000">www.wago.com/232-246/005-000</a>
	<b>Obj. č.: 232-246/005-000/039-000</b> Female connector for rail-mount terminal blocks; Úhlové provedení; Blokovací západka; Rozteč 5 mm; 16pól.; Šedá	<a href="http://www.wago.com/232-246/005-000/039-000">www.wago.com/232-246/005-000/039-000</a>
	<b>Obj. č.: 232-250/005-000</b> Female connector for rail-mount terminal blocks; Úhlové provedení; Rozteč 5 mm; 20pól.; Šedá	<a href="http://www.wago.com/232-250/005-000">www.wago.com/232-250/005-000</a>
	<b>Obj. č.: 232-250/005-000/039-000</b> Female connector for rail-mount terminal blocks; angled; Locking lever; Pin spacing 5 mm; 20-pole; gray	<a href="http://www.wago.com/232-250/005-000/039-000">www.wago.com/232-250/005-000/039-000</a>
	<b>Obj. č.: 232-732/005-000</b> Female connector for rail-mount terminal blocks; Rovné provedení; Rozteč 7,5 mm; 2pól.; Šedá	<a href="http://www.wago.com/232-732/005-000">www.wago.com/232-732/005-000</a>
	<b>Obj. č.: 232-733/005-000</b> Female connector for rail-mount terminal blocks; Rovné provedení; Rozteč 7,5 mm; 3pól.; Šedá	<a href="http://www.wago.com/232-733/005-000">www.wago.com/232-733/005-000</a>
	<b>Obj. č.: 232-734/005-000</b> Female connector for rail-mount terminal blocks; Rovné provedení; Rozteč 7,5 mm; 4pól.; Šedá	<a href="http://www.wago.com/232-734/005-000">www.wago.com/232-734/005-000</a>
	<b>Obj. č.: 232-734/005-000/039-000</b> Female connector for rail-mount terminal blocks; Rovné provedení; Rozteč 7,5 mm; 4pól.; Šedá	<a href="http://www.wago.com/232-734/005-000/039-000">www.wago.com/232-734/005-000/039-000</a>
	<b>Obj. č.: 232-735/005-000</b> Female connector for rail-mount terminal blocks; Rovné provedení; Rozteč 7,5 mm; 5pól.; Šedá	<a href="http://www.wago.com/232-735/005-000">www.wago.com/232-735/005-000</a>
	<b>Obj. č.: 232-735/005-000/039-000</b> Female connector for rail-mount terminal blocks; Rovné provedení; Rozteč 7,5 mm; 5pól.; Šedá	<a href="http://www.wago.com/232-735/005-000/039-000">www.wago.com/232-735/005-000/039-000</a>
	<b>Obj. č.: 232-736/005-000</b> Female connector for rail-mount terminal blocks; Rovné provedení; Rozteč 7,5 mm; 6pól.; Šedá	<a href="http://www.wago.com/232-736/005-000">www.wago.com/232-736/005-000</a>
	<b>Obj. č.: 232-736/005-000/039-000</b> Female connector for rail-mount terminal blocks; Rovné provedení; Rozteč 7,5 mm; 6pól.; Šedá	<a href="http://www.wago.com/232-736/005-000/039-000">www.wago.com/232-736/005-000/039-000</a>
	<b>Obj. č.: 232-738/005-000</b> Female connector for rail-mount terminal blocks; Rovné provedení; Rozteč 7,5 mm; 8pól.; Šedá	<a href="http://www.wago.com/232-738/005-000">www.wago.com/232-738/005-000</a>
	<b>Obj. č.: 232-740/005-000</b> Female connector for rail-mount terminal blocks; Rovné provedení; Rozteč 7,5 mm; 10pól.; Šedá	<a href="http://www.wago.com/232-740/005-000">www.wago.com/232-740/005-000</a>
	<b>Obj. č.: 232-742/005-000</b> Female connector for rail-mount terminal blocks; Rovné provedení; Rozteč 7,5 mm; 12pól.; Šedá	<a href="http://www.wago.com/232-742/005-000">www.wago.com/232-742/005-000</a>























	<b>Obj. č.: 232-832/005-000</b> Pružinová svorkovnice THT; 0,6 x 1,0 mm solder pin; Úhlové provedení; Rozteč 7,5 mm; 2pól.; Šedá	<a href="http://www.wago.com/232-832/005-000">www.wago.com/232-832/005-000</a>
	<b>Obj. č.: 232-833/005-000</b> Pružinová svorkovnice THT; 0,6 x 1,0 mm solder pin; Úhlové provedení; Rozteč 7,5 mm; 3pól.; Šedá	<a href="http://www.wago.com/232-833/005-000">www.wago.com/232-833/005-000</a>
	<b>Obj. č.: 232-834/005-000</b> Pružinová svorkovnice THT; 0,6 x 1,0 mm solder pin; Úhlové provedení; Rozteč 7,5 mm; 4pól.; Šedá	<a href="http://www.wago.com/232-834/005-000">www.wago.com/232-834/005-000</a>
	<b>Obj. č.: 232-836/005-000</b> Pružinová svorkovnice THT; 0,6 x 1,0 mm solder pin; Úhlové provedení; Rozteč 7,5 mm; 6pól.; Šedá	<a href="http://www.wago.com/232-836/005-000">www.wago.com/232-836/005-000</a>
	<b>Obj. č.: 232-836/005-000/039-000</b> Pružinová svorkovnice THT; 0,6 x 1,0 mm solder pin; Úhlové provedení; Blokovací západka; Rozteč 7,5 mm; 6pól.; Šedá	<a href="http://www.wago.com/232-836/005-000/039-000">www.wago.com/232-836/005-000/039-000</a>
	<b>Obj. č.: 232-840/005-000</b> Pružinová svorkovnice THT; 0,6 x 1,0 mm solder pin; Úhlové provedení; Rozteč 7,5 mm; 10pól.; Šedá	<a href="http://www.wago.com/232-840/005-000">www.wago.com/232-840/005-000</a>
	<b>Obj. č.: 232-842/005-000</b> THT female header; 0,6 x 1,0 mm solder pin; angled; Pin spacing 7.5 mm; 12-pole; gray	<a href="http://www.wago.com/232-842/005-000">www.wago.com/232-842/005-000</a>
	<b>Obj. č.: 722-132/005-000</b> Female connector for rail-mount terminal blocks; Rovné provedení; 100% ochrana proti chybnému zapojení; Rozteč 5 mm; 2pól.; Světle šedá	<a href="http://www.wago.com/722-132/005-000">www.wago.com/722-132/005-000</a>
	<b>Obj. č.: 722-132/005-000/039-000</b> Female connector for rail-mount terminal blocks; Rovné provedení; 100% ochrana proti chybnému zapojení; Blokovací západka; Rozteč 5 mm; 3pól.; Světle šedá	<a href="http://www.wago.com/722-132/005-000/039-000">www.wago.com/722-132/005-000/039-000</a>
	<b>Obj. č.: 722-133/005-000</b> Female connector for rail-mount terminal blocks; Rovné provedení; 100% ochrana proti chybnému zapojení; Rozteč 5 mm; 3pól.; Světle šedá	<a href="http://www.wago.com/722-133/005-000">www.wago.com/722-133/005-000</a>
	<b>Obj. č.: 722-133/005-000/039-000</b> Female connector for rail-mount terminal blocks; Rovné provedení; 100% ochrana proti chybnému zapojení; Blokovací západka; Rozteč 5 mm; 3pól.; Světle šedá	<a href="http://www.wago.com/722-133/005-000/039-000">www.wago.com/722-133/005-000/039-000</a>
	<b>Obj. č.: 722-134/005-000</b> Female connector for rail-mount terminal blocks; Rovné provedení; 100% ochrana proti chybnému zapojení; Rozteč 5 mm; 4pól.; Světle šedá	<a href="http://www.wago.com/722-134/005-000">www.wago.com/722-134/005-000</a>
	<b>Obj. č.: 722-134/005-000/039-000</b> Female connector for rail-mount terminal blocks; Rovné provedení; 100% ochrana proti chybnému zapojení; Blokovací západka; Rozteč 5 mm; 4pól.; Světle šedá	<a href="http://www.wago.com/722-134/005-000/039-000">www.wago.com/722-134/005-000/039-000</a>
	<b>Obj. č.: 722-135/005-000</b> Female connector for rail-mount terminal blocks; Rovné provedení; 100% ochrana proti chybnému zapojení; Rozteč 5 mm; 5pól.; Světle šedá	<a href="http://www.wago.com/722-135/005-000">www.wago.com/722-135/005-000</a>
	<b>Obj. č.: 722-135/005-000/039-000</b>	



	Female connector for rail-mount terminal blocks; Rovné provedení; 100% ochrana proti chybnému zapojení; Blokovací západka; Rozteč 5 mm; 5pól.; Světle šedá	<a href="http://www.wago.com/722-135/005-000/039-000">www.wago.com/722-135/005-000/039-000</a>
	<b>Obj. č.: 722-136/005-000</b> Female connector for rail-mount terminal blocks; Rovné provedení; 100% ochrana proti chybnému zapojení; Rozteč 5 mm; 6pól.; Světle šedá	<a href="http://www.wago.com/722-136/005-000">www.wago.com/722-136/005-000</a>
	<b>Obj. č.: 722-136/005-000/039-000</b> Female connector for rail-mount terminal blocks; Rovné provedení; 100% ochrana proti chybnému zapojení; Blokovací západka; Rozteč 5 mm; 6pól.; Světle šedá	<a href="http://www.wago.com/722-136/005-000/039-000">www.wago.com/722-136/005-000/039-000</a>
	<b>Obj. č.: 722-137/005-000</b> Female connector for rail-mount terminal blocks; Rovné provedení; 100% ochrana proti chybnému zapojení; Rozteč 5 mm; 7pól.; Světle šedá	<a href="http://www.wago.com/722-137/005-000">www.wago.com/722-137/005-000</a>
	<b>Obj. č.: 722-137/005-000/039-000</b> Female connector for rail-mount terminal blocks; Rovné provedení; 100% ochrana proti chybnému zapojení; Blokovací západka; Rozteč 5 mm; 7pól.; Světle šedá	<a href="http://www.wago.com/722-137/005-000/039-000">www.wago.com/722-137/005-000/039-000</a>
	<b>Obj. č.: 722-138/005-000</b> Female connector for rail-mount terminal blocks; Rovné provedení; 100% ochrana proti chybnému zapojení; Rozteč 5 mm; 8pól.; Světle šedá	<a href="http://www.wago.com/722-138/005-000">www.wago.com/722-138/005-000</a>
	<b>Obj. č.: 722-138/005-000/039-000</b> Female connector for rail-mount terminal blocks; Rovné provedení; 100% ochrana proti chybnému zapojení; Blokovací západka; Rozteč 5 mm; 8pól.; Světle šedá	<a href="http://www.wago.com/722-138/005-000/039-000">www.wago.com/722-138/005-000/039-000</a>
	<b>Obj. č.: 722-139/005-000</b> Female connector for rail-mount terminal blocks; Rovné provedení; 100% ochrana proti chybnému zapojení; Rozteč 5 mm; 9pól.; Světle šedá	<a href="http://www.wago.com/722-139/005-000">www.wago.com/722-139/005-000</a>
	<b>Obj. č.: 722-139/005-000/039-000</b> Female connector for rail-mount terminal blocks; Rovné provedení; 100% ochrana proti chybnému zapojení; Blokovací západka; Rozteč 5 mm; 9pól.; Světle šedá	<a href="http://www.wago.com/722-139/005-000/039-000">www.wago.com/722-139/005-000/039-000</a>
	<b>Obj. č.: 722-140/005-000</b> Female connector for rail-mount terminal blocks; Rovné provedení; 100% ochrana proti chybnému zapojení; Rozteč 5 mm; 10pól.; Světle šedá	<a href="http://www.wago.com/722-140/005-000">www.wago.com/722-140/005-000</a>
	<b>Obj. č.: 722-140/005-000/039-000</b> Female connector for rail-mount terminal blocks; Rovné provedení; 100% ochrana proti chybnému zapojení; Blokovací západka; Rozteč 5 mm; 10pól.; Světle šedá	<a href="http://www.wago.com/722-140/005-000/039-000">www.wago.com/722-140/005-000/039-000</a>
	<b>Obj. č.: 722-141/005-000</b> Female connector for rail-mount terminal blocks; Rovné provedení; 100% ochrana proti chybnému zapojení; Rozteč 5 mm; 11pól.; Světle šedá	<a href="http://www.wago.com/722-141/005-000">www.wago.com/722-141/005-000</a>
	<b>Obj. č.: 722-142/005-000</b> Female connector for rail-mount terminal blocks; Rovné provedení; 100% ochrana proti chybnému zapojení; Rozteč 5 mm; 12pól.; Světle šedá	<a href="http://www.wago.com/722-142/005-000">www.wago.com/722-142/005-000</a>
	<b>Obj. č.: 722-142/005-007/039-000</b> Female connector for rail-mount terminal blocks; Šedá	<a href="http://www.wago.com/722-142/005-007/039-000">www.wago.com/722-142/005-007/039-000</a>
	<b>Obj. č.: 722-143/005-000</b> Female connector for rail-mount terminal blocks; Rovné provedení; 100% ochrana proti chybnému	

	zapojení; Rozteč 5 mm; 13pól.; Světle šedá	<a href="http://www.wago.com/722-143/005-000">www.wago.com/722-143/005-000</a>
	<b>Obj. č.: 722-144/005-000</b> Female connector for rail-mount terminal blocks; straight; 100% protected against mismatching; Pin spacing 5 mm; 14-pole; light gray	<a href="http://www.wago.com/722-144/005-000">www.wago.com/722-144/005-000</a>
	<b>Obj. č.: 722-144/005-000/039-000</b> Female connector for rail-mount terminal blocks; Rovné provedení; 100% ochrana proti chybnému zapojení; Blokovací západka; Rozteč 5 mm; 14pól.; Světle šedá	<a href="http://www.wago.com/722-144/005-000/039-000">www.wago.com/722-144/005-000/039-000</a>
	<b>Obj. č.: 722-145/005-000</b> Female connector for rail-mount terminal blocks; Rovné provedení; 100% ochrana proti chybnému zapojení; Rozteč 5 mm; 15pól.; Světle šedá	<a href="http://www.wago.com/722-145/005-000">www.wago.com/722-145/005-000</a>
	<b>Obj. č.: 722-146/005-000</b> Female connector for rail-mount terminal blocks; Rovné provedení; 100% ochrana proti chybnému zapojení; Rozteč 5 mm; 16pól.; Světle šedá	<a href="http://www.wago.com/722-146/005-000">www.wago.com/722-146/005-000</a>
	<b>Obj. č.: 722-146/005-000/039-000</b> Female connector for rail-mount terminal blocks; straight; 100% protected against mismatching; Locking lever; Pin spacing 5 mm; 16-pole; light gray	<a href="http://www.wago.com/722-146/005-000/039-000">www.wago.com/722-146/005-000/039-000</a>
	<b>Obj. č.: 722-150/005-000</b> Female connector for rail-mount terminal blocks; Rovné provedení; 100% ochrana proti chybnému zapojení; Rozteč 5 mm; 20pól.; Světle šedá	<a href="http://www.wago.com/722-150/005-000">www.wago.com/722-150/005-000</a>
	<b>Obj. č.: 722-150/005-000/039-000</b> Female connector for rail-mount terminal blocks; Rovné provedení; 100% ochrana proti chybnému zapojení; Blokovací západka; Rozteč 5 mm; 20pól.; Světle šedá	<a href="http://www.wago.com/722-150/005-000/039-000">www.wago.com/722-150/005-000/039-000</a>
	<b>Obj. č.: 722-232/005-000</b> Female connector for rail-mount terminal blocks; Úhlové provedení; 100% ochrana proti chybnému zapojení; Rozteč 5 mm; 3pól.; Světle šedá	<a href="http://www.wago.com/722-232/005-000">www.wago.com/722-232/005-000</a>
	<b>Obj. č.: 722-232/005-000/039-000</b> Female connector for rail-mount terminal blocks; Úhlové provedení; 100% ochrana proti chybnému zapojení; Blokovací západka; Rozteč 5 mm; 3pól.; Světle šedá	<a href="http://www.wago.com/722-232/005-000/039-000">www.wago.com/722-232/005-000/039-000</a>
	<b>Obj. č.: 722-233/005-000</b> Female connector for rail-mount terminal blocks; Úhlové provedení; 100% ochrana proti chybnému zapojení; Rozteč 5 mm; 3pól.; Světle šedá	<a href="http://www.wago.com/722-233/005-000">www.wago.com/722-233/005-000</a>
	<b>Obj. č.: 722-233/005-000/039-000</b> Female connector for rail-mount terminal blocks; Úhlové provedení; 100% ochrana proti chybnému zapojení; Blokovací západka; Rozteč 5 mm; 3pól.; Světle šedá	<a href="http://www.wago.com/722-233/005-000/039-000">www.wago.com/722-233/005-000/039-000</a>
	<b>Obj. č.: 722-234/005-000</b> Female connector for rail-mount terminal blocks; Úhlové provedení; 100% ochrana proti chybnému zapojení; Rozteč 5 mm; 4pól.; Světle šedá	<a href="http://www.wago.com/722-234/005-000">www.wago.com/722-234/005-000</a>
	<b>Obj. č.: 722-234/005-000/039-000</b> Female connector for rail-mount terminal blocks; Úhlové provedení; 100% ochrana proti chybnému zapojení; Blokovací západka; Rozteč 5 mm; 4pól.; Světle šedá	<a href="http://www.wago.com/722-234/005-000/039-000">www.wago.com/722-234/005-000/039-000</a>
	<b>Obj. č.: 722-235/005-000</b> Female connector for rail-mount terminal blocks; Úhlové provedení; 100% ochrana proti chybnému	

	zapojení; Rozteč 5 mm; 5pól.; Světle šedá	<a href="http://www.wago.com/722-235/005-000">www.wago.com/722-235/005-000</a>
	<b>Obj. č.: 722-235/005-000/039-000</b> Female connector for rail-mount terminal blocks; Úhlové provedení; 100% ochrana proti chybnému zapojení; Blokovací západka; Rozteč 5 mm; 5pól.; Světle šedá	<a href="http://www.wago.com/722-235/005-000/039-000">www.wago.com/722-235/005-000/039-000</a>
	<b>Obj. č.: 722-236/005-000</b> Female connector for rail-mount terminal blocks; Úhlové provedení; 100% ochrana proti chybnému zapojení; Rozteč 5 mm; 6pól.; Světle šedá	<a href="http://www.wago.com/722-236/005-000">www.wago.com/722-236/005-000</a>
	<b>Obj. č.: 722-236/005-000/039-000</b> Female connector for rail-mount terminal blocks; Úhlové provedení; 100% ochrana proti chybnému zapojení; Blokovací západka; Rozteč 5 mm; 6pól.; Světle šedá	<a href="http://www.wago.com/722-236/005-000/039-000">www.wago.com/722-236/005-000/039-000</a>
	<b>Obj. č.: 722-237/005-000</b> Female connector for rail-mount terminal blocks; Úhlové provedení; 100% ochrana proti chybnému zapojení; Rozteč 5 mm; 7pól.; Světle šedá	<a href="http://www.wago.com/722-237/005-000">www.wago.com/722-237/005-000</a>
	<b>Obj. č.: 722-237/005-000/039-000</b> Female connector for rail-mount terminal blocks; Úhlové provedení; 100% ochrana proti chybnému zapojení; Blokovací západka; Rozteč 5 mm; 7pól.; Světle šedá	<a href="http://www.wago.com/722-237/005-000/039-000">www.wago.com/722-237/005-000/039-000</a>
	<b>Obj. č.: 722-238/005-000</b> Female connector for rail-mount terminal blocks; Úhlové provedení; 100% ochrana proti chybnému zapojení; Rozteč 5 mm; 8pól.; Světle šedá	<a href="http://www.wago.com/722-238/005-000">www.wago.com/722-238/005-000</a>
	<b>Obj. č.: 722-239/005-000</b> Female connector for rail-mount terminal blocks; Úhlové provedení; 100% ochrana proti chybnému zapojení; Rozteč 5 mm; 9pól.; Světle šedá	<a href="http://www.wago.com/722-239/005-000">www.wago.com/722-239/005-000</a>
	<b>Obj. č.: 722-239/005-000/039-000</b> Female connector for rail-mount terminal blocks; angled; 100% protected against mismating; Locking lever; Pin spacing 5 mm; 9-pole; light gray	<a href="http://www.wago.com/722-239/005-000/039-000">www.wago.com/722-239/005-000/039-000</a>
	<b>Obj. č.: 722-240/005-000</b> Female connector for rail-mount terminal blocks; Úhlové provedení; 100% ochrana proti chybnému zapojení; Rozteč 5 mm; 10pól.; Světle šedá	<a href="http://www.wago.com/722-240/005-000">www.wago.com/722-240/005-000</a>
	<b>Obj. č.: 722-240/005-000/039-000</b> Female connector for rail-mount terminal blocks; Úhlové provedení; 100% ochrana proti chybnému zapojení; Blokovací západka; Rozteč 5 mm; 10pól.; Světle šedá	<a href="http://www.wago.com/722-240/005-000/039-000">www.wago.com/722-240/005-000/039-000</a>
	<b>Obj. č.: 722-241/005-000</b> Female connector for rail-mount terminal blocks; Úhlové provedení; 100% ochrana proti chybnému zapojení; Rozteč 5 mm; 11pól.; Světle šedá	<a href="http://www.wago.com/722-241/005-000">www.wago.com/722-241/005-000</a>
	<b>Obj. č.: 722-242/005-000</b> Female connector for rail-mount terminal blocks; Úhlové provedení; 100% ochrana proti chybnému zapojení; Rozteč 5 mm; 12pól.; Světle šedá	<a href="http://www.wago.com/722-242/005-000">www.wago.com/722-242/005-000</a>
	<b>Obj. č.: 722-242/005-000/039-000</b> Female connector for rail-mount terminal blocks; angled; 100% protected against mismating; Locking lever; Pin spacing 5 mm; 12-pole; light gray	<a href="http://www.wago.com/722-242/005-000/039-000">www.wago.com/722-242/005-000/039-000</a>
	<b>Obj. č.: 722-243/005-000</b> Female connector for rail-mount terminal blocks; angled; 100% protected against mismating; Pin	

	spacing 5 mm; 13-pole; light gray	<a href="http://www.wago.com/722-243/005-000">www.wago.com/722-243/005-000</a>
	<b>Obj. č.: 722-244/005-000</b> Female connector for rail-mount terminal blocks; Úhlové provedení; 100% ochrana proti chybnému zapojení; Rozteč 5 mm; 14pól.; Světle šedá	<a href="http://www.wago.com/722-244/005-000">www.wago.com/722-244/005-000</a>
	<b>Obj. č.: 722-244/005-000/039-000</b> Female connector for rail-mount terminal blocks; Úhlové provedení; 100% ochrana proti chybnému zapojení; Blokovací západka; Rozteč 5 mm; 14pól.; Světle šedá	<a href="http://www.wago.com/722-244/005-000/039-000">www.wago.com/722-244/005-000/039-000</a>
	<b>Obj. č.: 722-246/005-000</b> Female connector for rail-mount terminal blocks; Úhlové provedení; 100% ochrana proti chybnému zapojení; Rozteč 5 mm; 16pól.; Světle šedá	<a href="http://www.wago.com/722-246/005-000">www.wago.com/722-246/005-000</a>
	<b>Obj. č.: 722-246/005-000/039-000</b> Female connector for rail-mount terminal blocks; Úhlové provedení; 100% ochrana proti chybnému zapojení; Blokovací západka; Rozteč 5 mm; 16pól.; Světle šedá	<a href="http://www.wago.com/722-246/005-000/039-000">www.wago.com/722-246/005-000/039-000</a>
	<b>Obj. č.: 722-250/005-000</b> Female connector for rail-mount terminal blocks; Úhlové provedení; 100% ochrana proti chybnému zapojení; Rozteč 5 mm; 20pól.; Světle šedá	<a href="http://www.wago.com/722-250/005-000">www.wago.com/722-250/005-000</a>

## Ke stažení

### Documentation

#### Additional Information

Technical explanations	03-Apr-2019	pdf 2,1 MB	Stáhnout
------------------------	-------------	---------------	----------

### CAD/CAE-Data

#### CAD data

2D/3D Models 280-547	URL	Stáhnout
----------------------	-----	----------

#### CAE data

EPLAN Data Portal 280-547	Stáhnout
---------------------------	----------

WSCAD Universe 280-547	Stáhnout
------------------------	----------

### Handling Instructions



Změny vyhrazeny.

---

WAGO Elektro spol. sr. o.  
Rozvodova 1116/36  
143 00 Praha 12 - Modřany  
Tel.: +420 261 090 143  
Email: [info.cz@wago.com](mailto:info.cz@wago.com), [wago-cz@wago.com](mailto:wago-cz@wago.com)

Máte otázky ohledně našich produktů?  
Kdykoli nám zavolejte na číslo +420 261 090 143.