

Datový list | Objednáací číslo: 280-537

Dvoupatrová svorka; Svorka pro ochranný vodič / průchozí svorka; S držákem popisu; Na DIN lištu 35 × 15 a 35 × 7,5; 2,5 mm<sup>2</sup>; CAGE CLAMP®; 2,50 mm<sup>2</sup>; Zeleno-žlutá/modrá

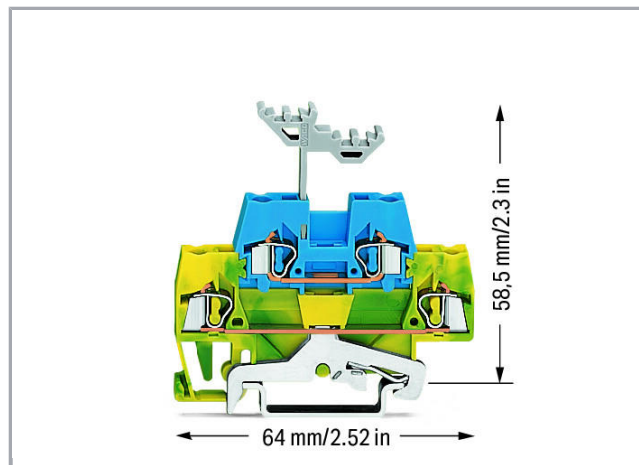

[www.wago.com/280-537](http://www.wago.com/280-537)



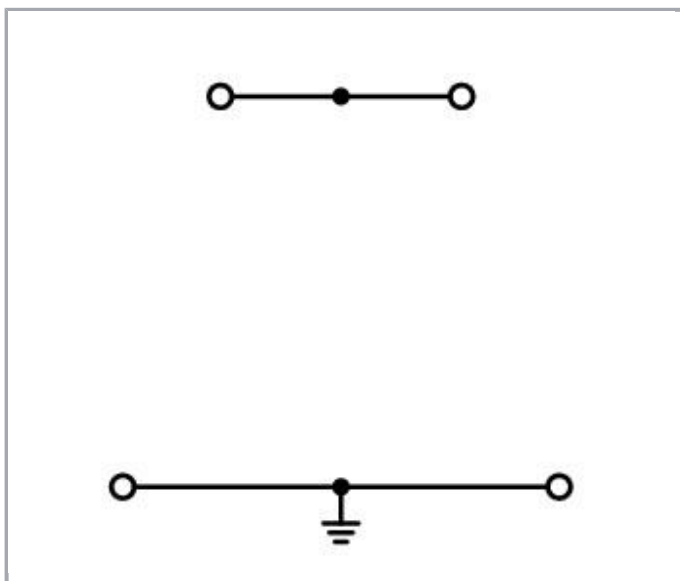

## Popis položky

### Upozornění:

#### Terminating Aluminum Conductors

WAGO spring clamp terminal blocks are suitable for solid aluminum conductors up to 4 mm<sup>2</sup>/12 AWG if WAGO "Alu-Plus" Contact Paste is used for termination.

"Alu-Plus" Contact Paste Advantages:

- Automatically destroys the oxide film during clamping.
- Prevents fresh oxidation at the clamping point.
- Prevents electrolytic corrosion between aluminum and copper conductors (in the same terminal block).
- Provides long-term protection against corrosion.

Using terminal blocks with CAGE CLAMP® Spring Pressure Connection Technology, **aluminum conductors must first be cleaned with a blade** and then immediately be inserted into the clamping units filled with "Alu-Plus" Contact Paste.

It is also possible to apply WAGO "Alu-Plus" **additionally** on the whole surface of the aluminum conductor before termination.

Please note that the nominal currents must be adapted to the reduced conductivity of the aluminum conductors:

2.5 mm<sup>2</sup> (14 AWG) = 16 A

4 mm<sup>2</sup> (12 AWG) = 22 A

## Data

### Elektrické parametry

#### Ratings per IEC/EN 60664-1

Návrhové napětí (III / 3)	500 V
Návrhové rázové napětí (III / 3)	6 kV



Jmenovitý proud	20 A
Legenda (návrhové hodnoty)	(III / 3) $\hat{=}$ kategorie přepětí III / stupeň znečištění 3

### Údaje o připojení

Připojovací technika	CAGE CLAMP®
Způsob ovládání	Ovládací nástroj
Materiály připojitelných vodičů	Měď Hliník
Plný vodič	0,08 ... 2,5 mm <sup>2</sup> / 28 ... 12 AWG
Jemně laněný vodič	0,08 ... 2,5 mm <sup>2</sup> / 28 ... 12 AWG
Délka odizolování	8 ... 9 mm / 0.31 ... 0.35 palec
Celkový počet kontaktních míst	4
Celkový počet potenciálů	2
Počet úrovní	2
Způsob zapojení	čelní připojení
Upozornění (průřez vodiče)	12 AWG: THHN, THWN

### Geometrické údaje

Šířka	5 mm / 0.197 inch
Výška od horní hrany lišty DIN 35	58,5 mm / 2.303 inch
Hloubka	64 mm / 2.52 inch

### Mechanické parametry

Provedení	Horizontální provedení
Způsob montáže	Lišta DIN 35
Úroveň popisování	Středový popis

### Údaje o materiálu



barva	Zeleno-žlutá/modrá
Izolační materiál	Polyamid 66 (PA 66)
Požární zatížení	0.154 MJ
Hmotnost	13.781 g

### Obchodní údaje



Product Group	1 (Rail Mounted Terminal Blocks)
Druh balení	BOX
Country of origin	DE
GTIN	4045454093990
Customs Tariff No.	85369010000

## Atesty/certifikáty

## Specifické atesty jednotlivých států

Logo	Schválení	Doplňkový text schválení	Název certifikátu
	CCA DEKRA Certification B.V.	EN 60947	2157201.01
	CSA DEKRA Certification B.V.	C22.2	1536071

## Atesty pro použití v lodním průmyslu

Logo	Schválení	Doplňkový text schválení	Název certifikátu
	ABS American Bureau of Shipping	EN 60947	14-HG1293677-PDA
	BV Bureau Veritas S.A.	EN 60947	07436/E0 BV
	LR Lloyds Register	EN 60947	91/20112 (E9)

## Atesty UL

Logo	Schválení	Doplňkový text schválení	Název certifikátu
	UR Underwriters Laboratories Inc.	UL 1059	20190731-E45172

## Kompatibilní produkty

## Protective Warning Marker

**Obj. č.: 280-415**

Výstražný kryt; S černým symbolem blesku; Pro 5 svorek; Žlutá

[www.wago.com/280-415](http://www.wago.com/280-415)

## General accessories

**Obj. č.: 231-162/003-000**

Male connector for rail-mount terminal blocks; 1.2 x 1.2 mm pins; Rovné provedení; Rozteč 5 mm; 2pól.; Šedá

[www.wago.com/231-162/003-000](http://www.wago.com/231-162/003-000)**Obj. č.: 231-163/003-000**

Male connector for rail-mount terminal blocks; 1.2 x 1.2 mm pins; Rovné provedení; Rozteč 5 mm; 3pól.; Šedá

[www.wago.com/231-163/003-000](http://www.wago.com/231-163/003-000)**Obj. č.: 231-164/003-000**

Male connector for rail-mount terminal blocks; 1.2 x 1.2 mm pins; Rovné provedení; Rozteč 5 mm; 4pól.; Šedá

[www.wago.com/231-164/003-000](http://www.wago.com/231-164/003-000)**Obj. č.: 231-165/003-000**

Male connector for rail-mount terminal blocks; 1.2 x 1.2 mm pins; Rovné provedení; Rozteč 5 mm; 5pól.; Šedá

[www.wago.com/231-165/003-000](http://www.wago.com/231-165/003-000)**Obj. č.: 231-166/003-000**

Male connector for rail-mount terminal blocks; 1.2 x 1.2 mm pins; Rovné provedení; Rozteč 5 mm; 6pól.; Šedá

[www.wago.com/231-166/003-000](http://www.wago.com/231-166/003-000)**Obj. č.: 231-167/003-000**

Male connector for rail-mount terminal blocks; 1.2 x 1.2 mm pins; Rovné provedení; Rozteč 5 mm; 7pól.; Šedá

[www.wago.com/231-167/003-000](http://www.wago.com/231-167/003-000)**Obj. č.: 231-168/003-000**

Male connector for rail-mount terminal blocks; 1.2 x 1.2 mm pins; Rovné provedení; Rozteč 5 mm; 8pól.; Šedá

[www.wago.com/231-168/003-000](http://www.wago.com/231-168/003-000)**Obj. č.: 231-169/003-000**

Male connector for rail-mount terminal blocks; 1.2 x 1.2 mm pins; Rovné provedení; Rozteč 5 mm; 9pól.; Šedá

[www.wago.com/231-169/003-000](http://www.wago.com/231-169/003-000)**Obj. č.: 231-170/003-000**

Male connector for rail-mount terminal blocks; 1.2 x 1.2 mm pins; Rovné provedení; Rozteč 5 mm; 10pól.; Šedá

[www.wago.com/231-170/003-000](http://www.wago.com/231-170/003-000)**Obj. č.: 231-171/003-000**

Male connector for rail-mount terminal blocks; 1.2 x 1.2 mm pins; Rovné provedení; Rozteč 5 mm; 11pól.; Šedá















[www.wago.com/231-171/003-000](http://www.wago.com/231-171/003-000)**Obj. č.: 231-172/003-000**















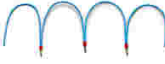

Male connector for rail-mount terminal blocks; 1.2 x 1.2 mm pins; Rovné provedení; Rozteč 5 mm; 12pól.; Šedá

















[www.wago.com/231-172/003-000](http://www.wago.com/231-172/003-000)**Obj. č.: 231-176/003-000**

Male connector for rail-mount terminal blocks; 1.2 x 1.2 mm pins; Rovné provedení; Rozteč 5 mm; 16pól.; Šedá















[www.wago.com/231-176/003-000](http://www.wago.com/231-176/003-000)















	<p><b>Obj. č.: 231-180/003-000</b>                      Male connector for rail-mount terminal blocks; 1.2 x 1.2 mm pins; Rovné provedení; Rozteč 5 mm; 20pól.; Šedá</p>	<a href="http://www.wago.com/231-180/003-000">www.wago.com/231-180/003-000</a>
	<p><b>Obj. č.: 231-668</b>                      Zavírací kolíky; K uzavření nepotřebných kontaktních míst; Šedá</p>	<a href="http://www.wago.com/231-668">www.wago.com/231-668</a>
	<p><b>Obj. č.: 231-669</b>                      Zavírací kolíky; K uzavření nepotřebných kontaktních míst; Oranžová</p>	<a href="http://www.wago.com/231-669">www.wago.com/231-669</a>
	<p><b>Obj. č.: 721-162/003-000</b>                      Male connector for rail-mount terminal blocks; 1.2 x 1.2 mm pins; Rovné provedení; 100% ochrana proti chybnému zapojení; Rozteč 5 mm; 2pól.; Světle šedá</p>	<a href="http://www.wago.com/721-162/003-000">www.wago.com/721-162/003-000</a>
	<p><b>Obj. č.: 721-163/003-000</b>                      Male connector for rail-mount terminal blocks; 1.2 x 1.2 mm pins; Rovné provedení; 100% ochrana proti chybnému zapojení; Rozteč 5 mm; 3pól.; Světle šedá</p>	<a href="http://www.wago.com/721-163/003-000">www.wago.com/721-163/003-000</a>
	<p><b>Obj. č.: 721-164/003-000</b>                      Male connector for rail-mount terminal blocks; 1.2 x 1.2 mm pins; straight; 100% protected against mismatching; Pin spacing 5 mm; 4-pole; light gray</p>	<a href="http://www.wago.com/721-164/003-000">www.wago.com/721-164/003-000</a>
	<p><b>Obj. č.: 721-165/003-000</b>                      Male connector for rail-mount terminal blocks; 1.2 x 1.2 mm pins; Rovné provedení; 100% ochrana proti chybnému zapojení; Rozteč 5 mm; 5pól.; Světle šedá</p>	<a href="http://www.wago.com/721-165/003-000">www.wago.com/721-165/003-000</a>
	<p><b>Obj. č.: 721-166/003-000</b>                      Male connector for rail-mount terminal blocks; 1.2 x 1.2 mm pins; Rovné provedení; 100% ochrana proti chybnému zapojení; Rozteč 5 mm; 6pól.; Světle šedá</p>	<a href="http://www.wago.com/721-166/003-000">www.wago.com/721-166/003-000</a>
	<p><b>Obj. č.: 721-167/003-000</b>                      Male connector for rail-mount terminal blocks; 1.2 x 1.2 mm pins; Rovné provedení; 100% ochrana proti chybnému zapojení; Rozteč 5 mm; 7pól.; Světle šedá</p>	<a href="http://www.wago.com/721-167/003-000">www.wago.com/721-167/003-000</a>
	<p><b>Obj. č.: 721-168/003-000</b>                      Male connector for rail-mount terminal blocks; 1.2 x 1.2 mm pins; Rovné provedení; 100% ochrana proti chybnému zapojení; Rozteč 5 mm; 8pól.; Světle šedá</p>	<a href="http://www.wago.com/721-168/003-000">www.wago.com/721-168/003-000</a>
	<p><b>Obj. č.: 721-169/003-000</b>                      Male connector for rail-mount terminal blocks; 1.2 x 1.2 mm pins; Rovné provedení; 100% ochrana proti chybnému zapojení; Rozteč 5 mm; 9pól.; Světle šedá</p>	<a href="http://www.wago.com/721-169/003-000">www.wago.com/721-169/003-000</a>
	<p><b>Obj. č.: 721-170/003-000</b>                      Male connector for rail-mount terminal blocks; 1.2 x 1.2 mm pins; Rovné provedení; 100% ochrana proti chybnému zapojení; Rozteč 5 mm; 10pól.; Světle šedá</p>	<a href="http://www.wago.com/721-170/003-000">www.wago.com/721-170/003-000</a>
	<p><b>Obj. č.: 721-171/003-000</b>                      Male connector for rail-mount terminal blocks; 1.2 x 1.2 mm pins; straight; 100% protected against mismatching; Pin spacing 5 mm; 11-pole; light gray</p>	<a href="http://www.wago.com/721-171/003-000">www.wago.com/721-171/003-000</a>
	<p><b>Obj. č.: 721-172/003-000</b>                      Male connector for rail-mount terminal blocks; 1.2 x 1.2 mm pins; Rovné provedení; 100% ochrana proti chybnému zapojení; Rozteč 5 mm; 12pól.; Světle šedá</p>	<a href="http://www.wago.com/721-172/003-000">www.wago.com/721-172/003-000</a>
	<p><b>Obj. č.: 721-173/003-000</b>                      Male connector for rail-mount terminal blocks; 1.2 x 1.2 mm pins; straight; 100% protected against mismatching; Pin spacing 5 mm; 13-pole; light gray</p>	<a href="http://www.wago.com/721-173/003-000">www.wago.com/721-173/003-000</a>















	<b>Obj. č.: 721-174/003-000</b> Male connector for rail-mount terminal blocks; 1.2 x 1.2 mm pins; straight; 100% protected against mismatching; Pin spacing 5 mm; 14-pole; light gray	<a href="http://www.wago.com/721-174/003-000">www.wago.com/721-174/003-000</a>
	<b>Obj. č.: 721-175/003-000</b> Male connector for rail-mount terminal blocks; 1.2 x 1.2 mm pins; straight; 100% protected against mismatching; Pin spacing 5 mm; 15-pole; light gray	<a href="http://www.wago.com/721-175/003-000">www.wago.com/721-175/003-000</a>
	<b>Obj. č.: 721-176/003-000</b> Male connector for rail-mount terminal blocks; 1.2 x 1.2 mm pins; Rovné provedení; 100% ochrana proti chybnému zapojení; Rozteč 5 mm; 16pól.; Světle šedá	<a href="http://www.wago.com/721-176/003-000">www.wago.com/721-176/003-000</a>
	<b>Obj. č.: 721-180/003-000</b> Male connector for rail-mount terminal blocks; 1.2 x 1.2 mm pins; straight; 100% protected against mismatching; Pin spacing 5 mm; 20-pole; light gray	<a href="http://www.wago.com/721-180/003-000">www.wago.com/721-180/003-000</a>
<b>Jumper</b>		
	<b>Obj. č.: 210-103</b> Vícenásobný vodičový můstek; Izolováno; 50 přípojek; Černá	<a href="http://www.wago.com/210-103">www.wago.com/210-103</a>
	<b>Obj. č.: 210-123</b> Vícenásobný vodičový můstek; Izolováno; 50 přípojek	<a href="http://www.wago.com/210-123">www.wago.com/210-123</a>
	<b>Obj. č.: 249-123</b> Vodičový můstek; Izolováno; L = 180 mm; Průřez vedení 0,75 mm <sup>2</sup>	<a href="http://www.wago.com/249-123">www.wago.com/249-123</a>
	<b>Obj. č.: 249-125</b> Vodičový můstek; Izolováno; L = 60 mm; Průřez vedení 0,75 mm <sup>2</sup>	<a href="http://www.wago.com/249-125">www.wago.com/249-125</a>
	<b>Obj. č.: 249-126</b> Vodičový můstek; Izolováno; L = 110 mm; Průřez vedení 0,75 mm <sup>2</sup>	<a href="http://www.wago.com/249-126">www.wago.com/249-126</a>
	<b>Obj. č.: 249-127</b> Vodičový můstek; Izolováno; L = 250 mm; Průřez vedení 0,75 mm <sup>2</sup>	<a href="http://www.wago.com/249-127">www.wago.com/249-127</a>
	<b>Obj. č.: 280-402</b> Příčný můstek; Izolováno; IN = IN svorky; Šedá	<a href="http://www.wago.com/280-402">www.wago.com/280-402</a>
	<b>Obj. č.: 280-409</b> Příčný můstek ob svorku; Izolováno; IN = IN svorky; Šedá	<a href="http://www.wago.com/280-409">www.wago.com/280-409</a>
	<b>Obj. č.: 280-482</b> Hřebenový můstek; Izolováno; 2x; IN = IN svorky; Šedá	<a href="http://www.wago.com/280-482">www.wago.com/280-482</a>
	<b>Obj. č.: 280-483</b> Hřebenový můstek; Izolováno; 3x; IN = IN svorky; Šedá	<a href="http://www.wago.com/280-483">www.wago.com/280-483</a>
	<b>Obj. č.: 280-484</b> Hřebenový můstek; Izolováno; 4x; IN = IN svorky; Šedá	<a href="http://www.wago.com/280-484">www.wago.com/280-484</a>
	<b>Obj. č.: 280-485</b> Hřebenový můstek; Izolováno; 5x; IN = IN svorky; Šedá	<a href="http://www.wago.com/280-485">www.wago.com/280-485</a>
	<b>Obj. č.: 280-490</b> Hřebenový můstek; Izolováno; 10x; IN = IN svorky; Šedá	<a href="http://www.wago.com/280-490">www.wago.com/280-490</a>
	<b>Obj. č.: 280-492</b> Hřebenový můstek ob svorku; Izolováno; 2x; IN = IN svorky; Šedá	<a href="http://www.wago.com/280-492">www.wago.com/280-492</a>















	<b>Obj. č.: 281-421</b> Vertikální můstek; Izolováno; Jmenovitý proud 24 A; Šedá	<a href="http://www.wago.com/281-421">www.wago.com/281-421</a>
	<b>Obj. č.: 709-110</b> Vícenásobný vodičový můstek; Izolováno; 4 přípojk; 3 × 110 mm; Černá	<a href="http://www.wago.com/709-110">www.wago.com/709-110</a>
	<b>Obj. č.: 709-111</b> Vícenásobný vodičový můstek; Izolováno; 3 přípojek; 2 × 120 mm; Černá	<a href="http://www.wago.com/709-111">www.wago.com/709-111</a>
	<b>Obj. č.: 709-112</b> Vícenásobný vodičový můstek; Izolováno; 3 přípojek; 2 × 170 mm; Černá	<a href="http://www.wago.com/709-112">www.wago.com/709-112</a>
	<b>Obj. č.: 780-452</b> Stupňovitý můstek; Izolováno; Z 1 na 2; Rozteč 5 mm; Vhodný pro 2vodičové pružinové svorkovnice; Šedá	<a href="http://www.wago.com/780-452">www.wago.com/780-452</a>
	<b>Obj. č.: 780-453</b> Stupňovitý můstek; Izolováno; z 1 na 3; Rozteč 5 mm; Vhodný pro 2vodičové pružinové svorkovnice; Šedá	<a href="http://www.wago.com/780-453">www.wago.com/780-453</a>
	<b>Obj. č.: 780-454</b> Stupňovitý můstek; Izolováno; Z 1 na 4; Rozteč 5 mm; Vhodný pro 2vodičové pružinové svorkovnice; Šedá	<a href="http://www.wago.com/780-454">www.wago.com/780-454</a>
	<b>Obj. č.: 780-455</b> Stupňovitý můstek; Izolováno; Z 1 na 5; Rozteč 5 mm; Vhodný pro 2vodičové pružinové svorkovnice; Šedá	<a href="http://www.wago.com/780-455">www.wago.com/780-455</a>
	<b>Obj. č.: 780-456</b> Stupňovitý můstek; Izolováno; Z 1 na 6; Rozteč 5 mm; Vhodný pro 2vodičové pružinové svorkovnice; Šedá	<a href="http://www.wago.com/780-456">www.wago.com/780-456</a>
	<b>Obj. č.: 780-457</b> Stupňovitý můstek; Izolováno; Z 1 na 7; Rozteč 5 mm; Vhodný pro 2vodičové pružinové svorkovnice; Šedá	<a href="http://www.wago.com/780-457">www.wago.com/780-457</a>
	<b>Obj. č.: 780-458</b> Stupňovitý můstek; Izolováno; Z 1 na 8; Rozteč 5 mm; Vhodný pro 2vodičové pružinové svorkovnice; Šedá	<a href="http://www.wago.com/780-458">www.wago.com/780-458</a>
<b>Carrier rail</b>		
	<b>Obj. č.: 210-112</b> Ocelová nosná lišta; 35 × 7,5 mm; Tloušťka 1 mm; Délka 2 m; Děrovaná; Dle normy EN 60715; Šířka otvorů 25 mm; vzdálenost mezi otvory 36 mm	<a href="http://www.wago.com/210-112">www.wago.com/210-112</a>
	<b>Obj. č.: 210-113</b> Ocelová nosná lišta; 35 × 7,5 mm; Tloušťka 1 mm; Délka 2 m; Neděrovaná; Dle normy EN 60715	<a href="http://www.wago.com/210-113">www.wago.com/210-113</a>
	<b>Obj. č.: 210-114</b> Ocelová nosná lišta; 35 × 15 mm; Tloušťka 1,5 mm; Délka 2 m; Neděrovaná; Podobné EN 60715	<a href="http://www.wago.com/210-114">www.wago.com/210-114</a>
	<b>Obj. č.: 210-115</b> Ocelová nosná lišta; 35 × 7,5 mm; Tloušťka 1 mm; Délka 2 m; Děrovaná; Dle normy EN 60715; Šířka otvorů 18 mm; vzdálenost mezi otvory 25 mm	<a href="http://www.wago.com/210-115">www.wago.com/210-115</a>
	<b>Obj. č.: 210-118</b> Ocelová nosná lišta; 35 × 15 mm; Tloušťka 2,3 mm; Délka 2 m; Neděrovaná; Dle normy EN 60715	<a href="http://www.wago.com/210-118">www.wago.com/210-118</a>
	<b>Obj. č.: 210-196</b> Hliníková nosná lišta; 35 × 8,2 mm; Tloušťka 1,6 mm; Délka 2 m; Neděrovaná; Podobné EN 60715; Stříbrná	<a href="http://www.wago.com/210-196">www.wago.com/210-196</a>
	<b>Obj. č.: 210-197</b> Ocelová nosná lišta; 35 × 15 mm; Tloušťka 1,5 mm; Délka 2 m; Děrovaná; Podobné EN 60715	<a href="http://www.wago.com/210-197">www.wago.com/210-197</a>

















	<b>Obj. č.: 210-198</b> Měděná nosná lišta; 35 × 15 mm; Tloušťka 2,3 mm; Délka 2 m; Neděrovaná; Dle normy EN 60715; Měděná	<a href="http://www.wago.com/210-198">www.wago.com/210-198</a>
	<b>Obj. č.: 210-504</b> Ocelová nosná lišta; 35 × 7,5 mm; Tloušťka 1 mm; Délka 2 m; Děrovaná; Pásově zinkováno; Dle normy EN 60715	<a href="http://www.wago.com/210-504">www.wago.com/210-504</a>
	<b>Obj. č.: 210-505</b> Ocelová nosná lišta; 35 × 7,5 mm; Tloušťka 1 mm; Délka 2 m; Neděrovaná; Pásově zinkováno; Dle normy EN 60715	<a href="http://www.wago.com/210-505">www.wago.com/210-505</a>
	<b>Obj. č.: 210-506</b> Ocelová nosná lišta; 35 × 15 mm; Tloušťka 1,5 mm; Délka 2 m; Neděrovaná; Pásově zinkováno; Podobné EN 60715	<a href="http://www.wago.com/210-506">www.wago.com/210-506</a>
	<b>Obj. č.: 210-508</b> Ocelová nosná lišta; 35 × 15 mm; Tloušťka 1,5 mm; Délka 2 m; Děrovaná; Pásově zinkováno; Podobné EN 60715	<a href="http://www.wago.com/210-508">www.wago.com/210-508</a>
<b>Female plug</b>		
	<b>Obj. č.: 232-132/005-000</b> Female connector for rail-mount terminal blocks; Rovné provedení; Rozteč 5 mm; 2pól.; Šedá	<a href="http://www.wago.com/232-132/005-000">www.wago.com/232-132/005-000</a>
	<b>Obj. č.: 232-132/005-000/039-000</b> Female connector for rail-mount terminal blocks; straight; Locking lever; Pin spacing 5 mm; 3-pole; gray	<a href="http://www.wago.com/232-132/005-000/039-000">www.wago.com/232-132/005-000/039-000</a>
	<b>Obj. č.: 232-133/005-000</b> Female connector for rail-mount terminal blocks; Rovné provedení; Rozteč 5 mm; 3pól.; Šedá	<a href="http://www.wago.com/232-133/005-000">www.wago.com/232-133/005-000</a>
	<b>Obj. č.: 232-133/005-000/039-000</b> Female connector for rail-mount terminal blocks; Rovné provedení; Blokovací západka; Rozteč 5 mm; 3pól.; Šedá	<a href="http://www.wago.com/232-133/005-000/039-000">www.wago.com/232-133/005-000/039-000</a>
	<b>Obj. č.: 232-134/005-000</b> Female connector for rail-mount terminal blocks; Rovné provedení; Rozteč 5 mm; 4pól.; Šedá	<a href="http://www.wago.com/232-134/005-000">www.wago.com/232-134/005-000</a>
	<b>Obj. č.: 232-134/005-000/039-000</b> Female connector for rail-mount terminal blocks; Rovné provedení; Blokovací západka; Rozteč 5 mm; 4pól.; Šedá	<a href="http://www.wago.com/232-134/005-000/039-000">www.wago.com/232-134/005-000/039-000</a>
	<b>Obj. č.: 232-135/005-000</b> Female connector for rail-mount terminal blocks; Rovné provedení; Rozteč 5 mm; 5pól.; Šedá	<a href="http://www.wago.com/232-135/005-000">www.wago.com/232-135/005-000</a>
	<b>Obj. č.: 232-135/005-000/039-000</b> Female connector for rail-mount terminal blocks; Rovné provedení; Blokovací západka; Rozteč 5 mm; 5pól.; Šedá	<a href="http://www.wago.com/232-135/005-000/039-000">www.wago.com/232-135/005-000/039-000</a>
	<b>Obj. č.: 232-136/005-000</b> Female connector for rail-mount terminal blocks; Rovné provedení; Rozteč 5 mm; 6pól.; Šedá	<a href="http://www.wago.com/232-136/005-000">www.wago.com/232-136/005-000</a>
	<b>Obj. č.: 232-136/005-000/039-000</b> Female connector for rail-mount terminal blocks; Rovné provedení; Blokovací západka; Rozteč 5 mm; 6pól.; Šedá	<a href="http://www.wago.com/232-136/005-000/039-000">www.wago.com/232-136/005-000/039-000</a>















	<b>Obj. č.: 232-137/005-000</b> Female connector for rail-mount terminal blocks; Rovné provedení; Rozteč 5 mm; 7pól.; Šedá	<a href="http://www.wago.com/232-137/005-000">www.wago.com/232-137/005-000</a>
	<b>Obj. č.: 232-137/005-000/039-000</b> Female connector for rail-mount terminal blocks; Rovné provedení; Blokovací západka; Rozteč 5 mm; 7pól.; Šedá	<a href="http://www.wago.com/232-137/005-000/039-000">www.wago.com/232-137/005-000/039-000</a>
	<b>Obj. č.: 232-138/005-000</b> Female connector for rail-mount terminal blocks; Rovné provedení; Rozteč 5 mm; 8pól.; Šedá	<a href="http://www.wago.com/232-138/005-000">www.wago.com/232-138/005-000</a>
	<b>Obj. č.: 232-138/005-000/039-000</b> Female connector for rail-mount terminal blocks; Rovné provedení; Blokovací západka; Rozteč 5 mm; 8pól.; Šedá	<a href="http://www.wago.com/232-138/005-000/039-000">www.wago.com/232-138/005-000/039-000</a>
	<b>Obj. č.: 232-139/005-000</b> Female connector for rail-mount terminal blocks; Rovné provedení; Rozteč 5 mm; 9pól.; Šedá	<a href="http://www.wago.com/232-139/005-000">www.wago.com/232-139/005-000</a>
	<b>Obj. č.: 232-139/005-000/039-000</b> Female connector for rail-mount terminal blocks; Rovné provedení; Blokovací západka; Rozteč 5 mm; 9pól.; Šedá	<a href="http://www.wago.com/232-139/005-000/039-000">www.wago.com/232-139/005-000/039-000</a>
	<b>Obj. č.: 232-140/005-000</b> Female connector for rail-mount terminal blocks; Rovné provedení; Rozteč 5 mm; 10pól.; Šedá	<a href="http://www.wago.com/232-140/005-000">www.wago.com/232-140/005-000</a>
	<b>Obj. č.: 232-140/005-000/039-000</b> Female connector for rail-mount terminal blocks; Rovné provedení; Blokovací západka; Rozteč 5 mm; 10pól.; Šedá	<a href="http://www.wago.com/232-140/005-000/039-000">www.wago.com/232-140/005-000/039-000</a>
	<b>Obj. č.: 232-142/005-000</b> Female connector for rail-mount terminal blocks; Rovné provedení; Rozteč 5 mm; 12pól.; Šedá	<a href="http://www.wago.com/232-142/005-000">www.wago.com/232-142/005-000</a>
	<b>Obj. č.: 232-142/005-000/039-000</b> Female connector for rail-mount terminal blocks; Rovné provedení; Blokovací západka; Rozteč 5 mm; 12pól.; Šedá	<a href="http://www.wago.com/232-142/005-000/039-000">www.wago.com/232-142/005-000/039-000</a>
	<b>Obj. č.: 232-146/005-000</b> Female connector for rail-mount terminal blocks; Rovné provedení; Rozteč 5 mm; 16pól.; Šedá	<a href="http://www.wago.com/232-146/005-000">www.wago.com/232-146/005-000</a>
	<b>Obj. č.: 232-146/005-000/039-000</b> Female connector for rail-mount terminal blocks; Rovné provedení; Blokovací západka; Rozteč 5 mm; 16pól.; Šedá	<a href="http://www.wago.com/232-146/005-000/039-000">www.wago.com/232-146/005-000/039-000</a>
	<b>Obj. č.: 232-147/005-000/039-000</b> Female connector for rail-mount terminal blocks; straight; Locking lever; Pin spacing 5 mm; 17-pole; gray	<a href="http://www.wago.com/232-147/005-000/039-000">www.wago.com/232-147/005-000/039-000</a>
	<b>Obj. č.: 232-150/005-000</b> Female connector for rail-mount terminal blocks; Rovné provedení; Rozteč 5 mm; 20pól.; Šedá	<a href="http://www.wago.com/232-150/005-000">www.wago.com/232-150/005-000</a>
	<b>Obj. č.: 232-150/005-000/039-000</b> Female connector for rail-mount terminal blocks; straight; Locking lever; Pin spacing 5 mm; 20-pole; gray	<a href="http://www.wago.com/232-150/005-000/039-000">www.wago.com/232-150/005-000/039-000</a>

	<b>Obj. č.: 232-232/005-000</b> Female connector for rail-mount terminal blocks; Úhlové provedení; Rozteč 5 mm; 2pól.; Šedá	<a href="http://www.wago.com/232-232/005-000">www.wago.com/232-232/005-000</a>
	<b>Obj. č.: 232-232/005-000/039-000</b> Female connector for rail-mount terminal blocks; Úhlové provedení; Blokovací západka; Rozteč 5 mm; 2pól.; Šedá	<a href="http://www.wago.com/232-232/005-000/039-000">www.wago.com/232-232/005-000/039-000</a>
	<b>Obj. č.: 232-233/005-000</b> Female connector for rail-mount terminal blocks; Úhlové provedení; Rozteč 5 mm; 3pól.; Šedá	<a href="http://www.wago.com/232-233/005-000">www.wago.com/232-233/005-000</a>
	<b>Obj. č.: 232-233/005-000/039-000</b> Female connector for rail-mount terminal blocks; angled; Locking lever; Pin spacing 5 mm; 3-pole; gray	<a href="http://www.wago.com/232-233/005-000/039-000">www.wago.com/232-233/005-000/039-000</a>
	<b>Obj. č.: 232-234/005-000</b> Female connector for rail-mount terminal blocks; Úhlové provedení; Rozteč 5 mm; 4pól.; Šedá	<a href="http://www.wago.com/232-234/005-000">www.wago.com/232-234/005-000</a>
	<b>Obj. č.: 232-234/005-000/039-000</b> Female connector for rail-mount terminal blocks; Úhlové provedení; Blokovací západka; Rozteč 5 mm; 4pól.; Šedá	<a href="http://www.wago.com/232-234/005-000/039-000">www.wago.com/232-234/005-000/039-000</a>
	<b>Obj. č.: 232-235/005-000</b> Female connector for rail-mount terminal blocks; Úhlové provedení; Rozteč 5 mm; 5pól.; Šedá	<a href="http://www.wago.com/232-235/005-000">www.wago.com/232-235/005-000</a>
	<b>Obj. č.: 232-235/005-000/039-000</b> Female connector for rail-mount terminal blocks; Úhlové provedení; Blokovací západka; Rozteč 5 mm; 5pól.; Šedá	<a href="http://www.wago.com/232-235/005-000/039-000">www.wago.com/232-235/005-000/039-000</a>
	<b>Obj. č.: 232-236/005-000</b> Female connector for rail-mount terminal blocks; Úhlové provedení; Rozteč 5 mm; 6pól.; Šedá	<a href="http://www.wago.com/232-236/005-000">www.wago.com/232-236/005-000</a>
	<b>Obj. č.: 232-236/005-000/039-000</b> Female connector for rail-mount terminal blocks; angled; Locking lever; Pin spacing 5 mm; 6-pole; gray	<a href="http://www.wago.com/232-236/005-000/039-000">www.wago.com/232-236/005-000/039-000</a>
	<b>Obj. č.: 232-237/005-000</b> Female connector for rail-mount terminal blocks; Úhlové provedení; Rozteč 5 mm; 7pól.; Šedá	<a href="http://www.wago.com/232-237/005-000">www.wago.com/232-237/005-000</a>
	<b>Obj. č.: 232-238/005-000</b> Female connector for rail-mount terminal blocks; Úhlové provedení; Rozteč 5 mm; 8pól.; Šedá	<a href="http://www.wago.com/232-238/005-000">www.wago.com/232-238/005-000</a>
	<b>Obj. č.: 232-239/005-000</b> Female connector for rail-mount terminal blocks; Úhlové provedení; Rozteč 5 mm; 9pól.; Šedá	<a href="http://www.wago.com/232-239/005-000">www.wago.com/232-239/005-000</a>
	<b>Obj. č.: 232-240/005-000</b> Female connector for rail-mount terminal blocks; Úhlové provedení; Rozteč 5 mm; 10pól.; Šedá	<a href="http://www.wago.com/232-240/005-000">www.wago.com/232-240/005-000</a>
	<b>Obj. č.: 232-240/005-000/039-000</b>	

	Female connector for rail-mount terminal blocks; Úhlové provedení; Blokovací západka; Rozteč 5 mm; 10pól.; Šedá	<a href="http://www.wago.com/232-240/005-000/039-000">www.wago.com/232-240/005-000/039-000</a>
	<b>Obj. č.: 232-242/005-000</b> Female connector for rail-mount terminal blocks; Úhlové provedení; Rozteč 5 mm; 12pól.; Šedá	<a href="http://www.wago.com/232-242/005-000">www.wago.com/232-242/005-000</a>
	<b>Obj. č.: 232-242/005-000/039-000</b> Female connector for rail-mount terminal blocks; Úhlové provedení; Blokovací západka; Rozteč 5 mm; 12pól.; Šedá	<a href="http://www.wago.com/232-242/005-000/039-000">www.wago.com/232-242/005-000/039-000</a>
	<b>Obj. č.: 232-246/005-000</b> Female connector for rail-mount terminal blocks; Úhlové provedení; Rozteč 5 mm; 16pól.; Šedá	<a href="http://www.wago.com/232-246/005-000">www.wago.com/232-246/005-000</a>
	<b>Obj. č.: 232-246/005-000/039-000</b> Female connector for rail-mount terminal blocks; Úhlové provedení; Blokovací západka; Rozteč 5 mm; 16pól.; Šedá	<a href="http://www.wago.com/232-246/005-000/039-000">www.wago.com/232-246/005-000/039-000</a>
	<b>Obj. č.: 232-250/005-000</b> Female connector for rail-mount terminal blocks; Úhlové provedení; Rozteč 5 mm; 20pól.; Šedá	<a href="http://www.wago.com/232-250/005-000">www.wago.com/232-250/005-000</a>
	<b>Obj. č.: 232-250/005-000/039-000</b> Female connector for rail-mount terminal blocks; angled; Locking lever; Pin spacing 5 mm; 20-pole; gray	<a href="http://www.wago.com/232-250/005-000/039-000">www.wago.com/232-250/005-000/039-000</a>
	<b>Obj. č.: 232-732/005-000</b> Female connector for rail-mount terminal blocks; Rovné provedení; Rozteč 7,5 mm; 2pól.; Šedá	<a href="http://www.wago.com/232-732/005-000">www.wago.com/232-732/005-000</a>
	<b>Obj. č.: 232-733/005-000</b> Female connector for rail-mount terminal blocks; Rovné provedení; Rozteč 7,5 mm; 3pól.; Šedá	<a href="http://www.wago.com/232-733/005-000">www.wago.com/232-733/005-000</a>
	<b>Obj. č.: 232-734/005-000</b> Female connector for rail-mount terminal blocks; Rovné provedení; Rozteč 7,5 mm; 4pól.; Šedá	<a href="http://www.wago.com/232-734/005-000">www.wago.com/232-734/005-000</a>
	<b>Obj. č.: 232-734/005-000/039-000</b> Female connector for rail-mount terminal blocks; Rovné provedení; Rozteč 7,5 mm; 4pól.; Šedá	<a href="http://www.wago.com/232-734/005-000/039-000">www.wago.com/232-734/005-000/039-000</a>
	<b>Obj. č.: 232-735/005-000</b> Female connector for rail-mount terminal blocks; Rovné provedení; Rozteč 7,5 mm; 5pól.; Šedá	<a href="http://www.wago.com/232-735/005-000">www.wago.com/232-735/005-000</a>
	<b>Obj. č.: 232-735/005-000/039-000</b> Female connector for rail-mount terminal blocks; Rovné provedení; Rozteč 7,5 mm; 5pól.; Šedá	<a href="http://www.wago.com/232-735/005-000/039-000">www.wago.com/232-735/005-000/039-000</a>
	<b>Obj. č.: 232-736/005-000</b> Female connector for rail-mount terminal blocks; Rovné provedení; Rozteč 7,5 mm; 6pól.; Šedá	<a href="http://www.wago.com/232-736/005-000">www.wago.com/232-736/005-000</a>
	<b>Obj. č.: 232-736/005-000/039-000</b> Female connector for rail-mount terminal blocks; Rovné provedení; Rozteč 7,5 mm; 6pól.; Šedá	<a href="http://www.wago.com/232-736/005-000/039-000">www.wago.com/232-736/005-000/039-000</a>



	<b>Obj. č.: 232-738/005-000</b> Female connector for rail-mount terminal blocks; Rovné provedení; Rozteč 7,5 mm; 8pól.; Šedá	<a href="http://www.wago.com/232-738/005-000">www.wago.com/232-738/005-000</a>
	<b>Obj. č.: 232-740/005-000</b> Female connector for rail-mount terminal blocks; Rovné provedení; Rozteč 7,5 mm; 10pól.; Šedá	<a href="http://www.wago.com/232-740/005-000">www.wago.com/232-740/005-000</a>
	<b>Obj. č.: 232-742/005-000</b> Female connector for rail-mount terminal blocks; Rovné provedení; Rozteč 7,5 mm; 12pól.; Šedá	<a href="http://www.wago.com/232-742/005-000">www.wago.com/232-742/005-000</a>
	<b>Obj. č.: 232-832/005-000</b> Pružinová svorkovnice THT; 0,6 x 1,0 mm solder pin; Úhlové provedení; Rozteč 7,5 mm; 2pól.; Šedá	<a href="http://www.wago.com/232-832/005-000">www.wago.com/232-832/005-000</a>
	<b>Obj. č.: 232-833/005-000</b> Pružinová svorkovnice THT; 0,6 x 1,0 mm solder pin; Úhlové provedení; Rozteč 7,5 mm; 3pól.; Šedá	<a href="http://www.wago.com/232-833/005-000">www.wago.com/232-833/005-000</a>
	<b>Obj. č.: 232-834/005-000</b> Pružinová svorkovnice THT; 0,6 x 1,0 mm solder pin; Úhlové provedení; Rozteč 7,5 mm; 4pól.; Šedá	<a href="http://www.wago.com/232-834/005-000">www.wago.com/232-834/005-000</a>
	<b>Obj. č.: 232-836/005-000</b> Pružinová svorkovnice THT; 0,6 x 1,0 mm solder pin; Úhlové provedení; Rozteč 7,5 mm; 6pól.; Šedá	<a href="http://www.wago.com/232-836/005-000">www.wago.com/232-836/005-000</a>
	<b>Obj. č.: 232-836/005-000/039-000</b> Pružinová svorkovnice THT; 0,6 x 1,0 mm solder pin; Úhlové provedení; Blokovací západka; Rozteč 7,5 mm; 6pól.; Šedá	<a href="http://www.wago.com/232-836/005-000/039-000">www.wago.com/232-836/005-000/039-000</a>
	<b>Obj. č.: 232-840/005-000</b> Pružinová svorkovnice THT; 0,6 x 1,0 mm solder pin; Úhlové provedení; Rozteč 7,5 mm; 10pól.; Šedá	<a href="http://www.wago.com/232-840/005-000">www.wago.com/232-840/005-000</a>
	<b>Obj. č.: 232-842/005-000</b> THT female header; 0,6 x 1,0 mm solder pin; angled; Pin spacing 7.5 mm; 12-pole; gray	<a href="http://www.wago.com/232-842/005-000">www.wago.com/232-842/005-000</a>
	<b>Obj. č.: 722-132/005-000</b> Female connector for rail-mount terminal blocks; Rovné provedení; 100% ochrana proti chybnému zapojení; Rozteč 5 mm; 2pól.; Světle šedá	<a href="http://www.wago.com/722-132/005-000">www.wago.com/722-132/005-000</a>
	<b>Obj. č.: 722-132/005-000/039-000</b> Female connector for rail-mount terminal blocks; Rovné provedení; 100% ochrana proti chybnému zapojení; Blokovací západka; Rozteč 5 mm; 3pól.; Světle šedá	<a href="http://www.wago.com/722-132/005-000/039-000">www.wago.com/722-132/005-000/039-000</a>
	<b>Obj. č.: 722-133/005-000</b> Female connector for rail-mount terminal blocks; Rovné provedení; 100% ochrana proti chybnému zapojení; Rozteč 5 mm; 3pól.; Světle šedá	<a href="http://www.wago.com/722-133/005-000">www.wago.com/722-133/005-000</a>
	<b>Obj. č.: 722-133/005-000/039-000</b> Female connector for rail-mount terminal blocks; Rovné provedení; 100% ochrana proti chybnému zapojení; Blokovací západka; Rozteč 5 mm; 3pól.; Světle šedá	<a href="http://www.wago.com/722-133/005-000/039-000">www.wago.com/722-133/005-000/039-000</a>

	<b>Obj. č.: 722-134/005-000</b> Female connector for rail-mount terminal blocks; Rovné provedení; 100% ochrana proti chybnému zapojení; Rozteč 5 mm; 4pól.; Světlo šedá	<a href="http://www.wago.com/722-134/005-000">www.wago.com/722-134/005-000</a>
	<b>Obj. č.: 722-134/005-000/039-000</b> Female connector for rail-mount terminal blocks; Rovné provedení; 100% ochrana proti chybnému zapojení; Blokovací západka; Rozteč 5 mm; 4pól.; Světlo šedá	<a href="http://www.wago.com/722-134/005-000/039-000">www.wago.com/722-134/005-000/039-000</a>
	<b>Obj. č.: 722-135/005-000</b> Female connector for rail-mount terminal blocks; Rovné provedení; 100% ochrana proti chybnému zapojení; Rozteč 5 mm; 5pól.; Světlo šedá	<a href="http://www.wago.com/722-135/005-000">www.wago.com/722-135/005-000</a>
	<b>Obj. č.: 722-135/005-000/039-000</b> Female connector for rail-mount terminal blocks; Rovné provedení; 100% ochrana proti chybnému zapojení; Blokovací západka; Rozteč 5 mm; 5pól.; Světlo šedá	<a href="http://www.wago.com/722-135/005-000/039-000">www.wago.com/722-135/005-000/039-000</a>
	<b>Obj. č.: 722-136/005-000</b> Female connector for rail-mount terminal blocks; Rovné provedení; 100% ochrana proti chybnému zapojení; Rozteč 5 mm; 6pól.; Světlo šedá	<a href="http://www.wago.com/722-136/005-000">www.wago.com/722-136/005-000</a>
	<b>Obj. č.: 722-136/005-000/039-000</b> Female connector for rail-mount terminal blocks; Rovné provedení; 100% ochrana proti chybnému zapojení; Blokovací západka; Rozteč 5 mm; 6pól.; Světlo šedá	<a href="http://www.wago.com/722-136/005-000/039-000">www.wago.com/722-136/005-000/039-000</a>
	<b>Obj. č.: 722-137/005-000</b> Female connector for rail-mount terminal blocks; Rovné provedení; 100% ochrana proti chybnému zapojení; Rozteč 5 mm; 7pól.; Světlo šedá	<a href="http://www.wago.com/722-137/005-000">www.wago.com/722-137/005-000</a>
	<b>Obj. č.: 722-137/005-000/039-000</b> Female connector for rail-mount terminal blocks; Rovné provedení; 100% ochrana proti chybnému zapojení; Blokovací západka; Rozteč 5 mm; 7pól.; Světlo šedá	<a href="http://www.wago.com/722-137/005-000/039-000">www.wago.com/722-137/005-000/039-000</a>
	<b>Obj. č.: 722-138/005-000</b> Female connector for rail-mount terminal blocks; Rovné provedení; 100% ochrana proti chybnému zapojení; Rozteč 5 mm; 8pól.; Světlo šedá	<a href="http://www.wago.com/722-138/005-000">www.wago.com/722-138/005-000</a>
	<b>Obj. č.: 722-138/005-000/039-000</b> Female connector for rail-mount terminal blocks; Rovné provedení; 100% ochrana proti chybnému zapojení; Blokovací západka; Rozteč 5 mm; 8pól.; Světlo šedá	<a href="http://www.wago.com/722-138/005-000/039-000">www.wago.com/722-138/005-000/039-000</a>
	<b>Obj. č.: 722-139/005-000</b> Female connector for rail-mount terminal blocks; Rovné provedení; 100% ochrana proti chybnému zapojení; Rozteč 5 mm; 9pól.; Světlo šedá	<a href="http://www.wago.com/722-139/005-000">www.wago.com/722-139/005-000</a>
	<b>Obj. č.: 722-139/005-000/039-000</b> Female connector for rail-mount terminal blocks; Rovné provedení; 100% ochrana proti chybnému zapojení; Blokovací západka; Rozteč 5 mm; 9pól.; Světlo šedá	<a href="http://www.wago.com/722-139/005-000/039-000">www.wago.com/722-139/005-000/039-000</a>
	<b>Obj. č.: 722-140/005-000</b> Female connector for rail-mount terminal blocks; Rovné provedení; 100% ochrana proti chybnému zapojení; Rozteč 5 mm; 10pól.; Světlo šedá	<a href="http://www.wago.com/722-140/005-000">www.wago.com/722-140/005-000</a>
	<b>Obj. č.: 722-140/005-000/039-000</b> Female connector for rail-mount terminal blocks; Rovné provedení; 100% ochrana proti chybnému zapojení; Blokovací západka; Rozteč 5 mm; 10pól.; Světlo šedá	<a href="http://www.wago.com/722-140/005-000/039-000">www.wago.com/722-140/005-000/039-000</a>
	<b>Obj. č.: 722-141/005-000</b> Female connector for rail-mount terminal blocks; Rovné provedení; 100% ochrana proti chybnému zapojení; Rozteč 5 mm; 11pól.; Světlo šedá	<a href="http://www.wago.com/722-141/005-000">www.wago.com/722-141/005-000</a>

zapojení; Rozteč 5 mm; 11pól.; Světle šedá

**Obj. č.: 722-142/005-000**

Female connector for rail-mount terminal blocks; Rovné provedení; 100% ochrana proti chybnému zapojení; Rozteč 5 mm; 12pól.; Světle šedá

[www.wago.com/722-142/005-000](http://www.wago.com/722-142/005-000)**Obj. č.: 722-142/005-007/039-000**

Female connector for rail-mount terminal blocks; Šedá

[www.wago.com/722-142/005-007/039-000](http://www.wago.com/722-142/005-007/039-000)**Obj. č.: 722-143/005-000**

Female connector for rail-mount terminal blocks; Rovné provedení; 100% ochrana proti chybnému zapojení; Rozteč 5 mm; 13pól.; Světle šedá

[www.wago.com/722-143/005-000](http://www.wago.com/722-143/005-000)**Obj. č.: 722-144/005-000**

Female connector for rail-mount terminal blocks; straight; 100% protected against mismatching; Pin spacing 5 mm; 14-pole; light gray

[www.wago.com/722-144/005-000](http://www.wago.com/722-144/005-000)**Obj. č.: 722-144/005-000/039-000**

Female connector for rail-mount terminal blocks; Rovné provedení; 100% ochrana proti chybnému zapojení; Blokovací západka; Rozteč 5 mm; 14pól.; Světle šedá

[www.wago.com/722-144/005-000/039-000](http://www.wago.com/722-144/005-000/039-000)**Obj. č.: 722-145/005-000**

Female connector for rail-mount terminal blocks; Rovné provedení; 100% ochrana proti chybnému zapojení; Rozteč 5 mm; 15pól.; Světle šedá

[www.wago.com/722-145/005-000](http://www.wago.com/722-145/005-000)**Obj. č.: 722-146/005-000**

Female connector for rail-mount terminal blocks; Rovné provedení; 100% ochrana proti chybnému zapojení; Rozteč 5 mm; 16pól.; Světle šedá

[www.wago.com/722-146/005-000](http://www.wago.com/722-146/005-000)**Obj. č.: 722-146/005-000/039-000**

Female connector for rail-mount terminal blocks; straight; 100% protected against mismatching; Locking lever; Pin spacing 5 mm; 16-pole; light gray

[www.wago.com/722-146/005-000/039-000](http://www.wago.com/722-146/005-000/039-000)**Obj. č.: 722-150/005-000**

Female connector for rail-mount terminal blocks; Rovné provedení; 100% ochrana proti chybnému zapojení; Rozteč 5 mm; 20pól.; Světle šedá

[www.wago.com/722-150/005-000](http://www.wago.com/722-150/005-000)**Obj. č.: 722-150/005-000/039-000**

Female connector for rail-mount terminal blocks; Rovné provedení; 100% ochrana proti chybnému zapojení; Blokovací západka; Rozteč 5 mm; 20pól.; Světle šedá

[www.wago.com/722-150/005-000/039-000](http://www.wago.com/722-150/005-000/039-000)**Obj. č.: 722-232/005-000**

Female connector for rail-mount terminal blocks; Úhlové provedení; 100% ochrana proti chybnému zapojení; Rozteč 5 mm; 3pól.; Světle šedá

[www.wago.com/722-232/005-000](http://www.wago.com/722-232/005-000)**Obj. č.: 722-232/005-000/039-000**

Female connector for rail-mount terminal blocks; Úhlové provedení; 100% ochrana proti chybnému zapojení; Blokovací západka; Rozteč 5 mm; 3pól.; Světle šedá















[www.wago.com/722-232/005-000/039-000](http://www.wago.com/722-232/005-000/039-000)**Obj. č.: 722-233/005-000**

Female connector for rail-mount terminal blocks; Úhlové provedení; 100% ochrana proti chybnému zapojení; Rozteč 5 mm; 3pól.; Světle šedá















[www.wago.com/722-233/005-000](http://www.wago.com/722-233/005-000)**Obj. č.: 722-233/005-000/039-000**















Female connector for rail-mount terminal blocks; Úhlové provedení; 100% ochrana proti chybnému zapojení; Blokovací západka; Rozteč 5 mm; 3pól.; Světle šedá

















[www.wago.com/722-233/005-000/039-000](http://www.wago.com/722-233/005-000/039-000)**Obj. č.: 722-234/005-000**







	Female connector for rail-mount terminal blocks; Úhlové provedení; 100% ochrana proti chybnému zapojení; Rozteč 5 mm; 4pól.; Světle šedá	<a href="http://www.wago.com/722-234/005-000">www.wago.com/722-234/005-000</a>
	<b>Obj. č.: 722-234/005-000/039-000</b> Female connector for rail-mount terminal blocks; Úhlové provedení; 100% ochrana proti chybnému zapojení; Blokovací západka; Rozteč 5 mm; 4pól.; Světle šedá	<a href="http://www.wago.com/722-234/005-000/039-000">www.wago.com/722-234/005-000/039-000</a>
	<b>Obj. č.: 722-235/005-000</b> Female connector for rail-mount terminal blocks; Úhlové provedení; 100% ochrana proti chybnému zapojení; Rozteč 5 mm; 5pól.; Světle šedá	<a href="http://www.wago.com/722-235/005-000">www.wago.com/722-235/005-000</a>
	<b>Obj. č.: 722-235/005-000/039-000</b> Female connector for rail-mount terminal blocks; Úhlové provedení; 100% ochrana proti chybnému zapojení; Blokovací západka; Rozteč 5 mm; 5pól.; Světle šedá	<a href="http://www.wago.com/722-235/005-000/039-000">www.wago.com/722-235/005-000/039-000</a>
	<b>Obj. č.: 722-236/005-000</b> Female connector for rail-mount terminal blocks; Úhlové provedení; 100% ochrana proti chybnému zapojení; Rozteč 5 mm; 6pól.; Světle šedá	<a href="http://www.wago.com/722-236/005-000">www.wago.com/722-236/005-000</a>
	<b>Obj. č.: 722-236/005-000/039-000</b> Female connector for rail-mount terminal blocks; Úhlové provedení; 100% ochrana proti chybnému zapojení; Blokovací západka; Rozteč 5 mm; 6pól.; Světle šedá	<a href="http://www.wago.com/722-236/005-000/039-000">www.wago.com/722-236/005-000/039-000</a>
	<b>Obj. č.: 722-237/005-000</b> Female connector for rail-mount terminal blocks; Úhlové provedení; 100% ochrana proti chybnému zapojení; Rozteč 5 mm; 7pól.; Světle šedá	<a href="http://www.wago.com/722-237/005-000">www.wago.com/722-237/005-000</a>
	<b>Obj. č.: 722-237/005-000/039-000</b> Female connector for rail-mount terminal blocks; Úhlové provedení; 100% ochrana proti chybnému zapojení; Blokovací západka; Rozteč 5 mm; 7pól.; Světle šedá	<a href="http://www.wago.com/722-237/005-000/039-000">www.wago.com/722-237/005-000/039-000</a>
	<b>Obj. č.: 722-238/005-000</b> Female connector for rail-mount terminal blocks; Úhlové provedení; 100% ochrana proti chybnému zapojení; Rozteč 5 mm; 8pól.; Světle šedá	<a href="http://www.wago.com/722-238/005-000">www.wago.com/722-238/005-000</a>
	<b>Obj. č.: 722-239/005-000</b> Female connector for rail-mount terminal blocks; Úhlové provedení; 100% ochrana proti chybnému zapojení; Rozteč 5 mm; 9pól.; Světle šedá	<a href="http://www.wago.com/722-239/005-000">www.wago.com/722-239/005-000</a>
	<b>Obj. č.: 722-239/005-000/039-000</b> Female connector for rail-mount terminal blocks; angled; 100% protected against mismatching; Locking lever; Pin spacing 5 mm; 9-pole; light gray	<a href="http://www.wago.com/722-239/005-000/039-000">www.wago.com/722-239/005-000/039-000</a>
	<b>Obj. č.: 722-240/005-000</b> Female connector for rail-mount terminal blocks; Úhlové provedení; 100% ochrana proti chybnému zapojení; Rozteč 5 mm; 10pól.; Světle šedá	<a href="http://www.wago.com/722-240/005-000">www.wago.com/722-240/005-000</a>
	<b>Obj. č.: 722-240/005-000/039-000</b> Female connector for rail-mount terminal blocks; Úhlové provedení; 100% ochrana proti chybnému zapojení; Blokovací západka; Rozteč 5 mm; 10pól.; Světle šedá	<a href="http://www.wago.com/722-240/005-000/039-000">www.wago.com/722-240/005-000/039-000</a>
	<b>Obj. č.: 722-241/005-000</b> Female connector for rail-mount terminal blocks; Úhlové provedení; 100% ochrana proti chybnému zapojení; Rozteč 5 mm; 11pól.; Světle šedá	<a href="http://www.wago.com/722-241/005-000">www.wago.com/722-241/005-000</a>
	<b>Obj. č.: 722-242/005-000</b> Female connector for rail-mount terminal blocks; Úhlové provedení; 100% ochrana proti chybnému zapojení; Rozteč 5 mm; 12pól.; Světle šedá	<a href="http://www.wago.com/722-242/005-000">www.wago.com/722-242/005-000</a>



	<b>Obj. č.: 722-242/005-000/039-000</b> Female connector for rail-mount terminal blocks; angled; 100% protected against mismating; Locking lever; Pin spacing 5 mm; 12-pole; light gray	<a href="http://www.wago.com/722-242/005-000/039-000">www.wago.com/722-242/005-000/039-000</a>
	<b>Obj. č.: 722-243/005-000</b> Female connector for rail-mount terminal blocks; angled; 100% protected against mismating; Pin spacing 5 mm; 13-pole; light gray	<a href="http://www.wago.com/722-243/005-000">www.wago.com/722-243/005-000</a>
	<b>Obj. č.: 722-244/005-000</b> Female connector for rail-mount terminal blocks; Úhlové provedení; 100% ochrana proti chybnému zapojení; Rozteč 5 mm; 14pól.; Světle šedá	<a href="http://www.wago.com/722-244/005-000">www.wago.com/722-244/005-000</a>
	<b>Obj. č.: 722-244/005-000/039-000</b> Female connector for rail-mount terminal blocks; Úhlové provedení; 100% ochrana proti chybnému zapojení; Blokovací západka; Rozteč 5 mm; 14pól.; Světle šedá	<a href="http://www.wago.com/722-244/005-000/039-000">www.wago.com/722-244/005-000/039-000</a>
	<b>Obj. č.: 722-246/005-000</b> Female connector for rail-mount terminal blocks; Úhlové provedení; 100% ochrana proti chybnému zapojení; Rozteč 5 mm; 16pól.; Světle šedá	<a href="http://www.wago.com/722-246/005-000">www.wago.com/722-246/005-000</a>
	<b>Obj. č.: 722-246/005-000/039-000</b> Female connector for rail-mount terminal blocks; Úhlové provedení; 100% ochrana proti chybnému zapojení; Blokovací západka; Rozteč 5 mm; 16pól.; Světle šedá	<a href="http://www.wago.com/722-246/005-000/039-000">www.wago.com/722-246/005-000/039-000</a>
	<b>Obj. č.: 722-250/005-000</b> Female connector for rail-mount terminal blocks; Úhlové provedení; 100% ochrana proti chybnému zapojení; Rozteč 5 mm; 20pól.; Světle šedá	<a href="http://www.wago.com/722-250/005-000">www.wago.com/722-250/005-000</a>
<b>tools</b>		
	<b>Obj. č.: 210-657</b> Ovládací nástroj; Břit: 3,5 × 0,5 mm; S částečně izolovanou rukojetí; Krátké	<a href="http://www.wago.com/210-657">www.wago.com/210-657</a>
	<b>Obj. č.: 210-658</b> Ovládací nástroj; Břit: 3,5 × 0,5 mm; S částečně izolovanou rukojetí; Úhlové provedení; Krátké	<a href="http://www.wago.com/210-658">www.wago.com/210-658</a>
	<b>Obj. č.: 210-720</b> Ovládací nástroj; Břit: 3,5 × 0,5 mm; S částečně izolovanou rukojetí	<a href="http://www.wago.com/210-720">www.wago.com/210-720</a>
<b>End plate</b>		
	<b>Obj. č.: 280-340</b> Koncová bočnice a separátor; Tloušťka 2,5 mm; Šedá	<a href="http://www.wago.com/280-340">www.wago.com/280-340</a>
	<b>Obj. č.: 280-341</b> Koncová bočnice a separátor; Tloušťka 2,5 mm; Oranžová	<a href="http://www.wago.com/280-341">www.wago.com/280-341</a>
	<b>Obj. č.: 280-366</b> Odděľující deska; Tloušťka 1,1 mm; Oranžová	<a href="http://www.wago.com/280-366">www.wago.com/280-366</a>
<b>Marking accessories</b>		
	<b>Obj. č.: 2009-115</b> WMB Inline; Pro Smart Printer; Na cívce; Flexibilní, 5–5,2 mm; Bez potisku; Možnost naklapnutí; Bílá	<a href="http://www.wago.com/2009-115">www.wago.com/2009-115</a>
	<b>Obj. č.: 2009-115/000-002</b> WMB Inline; Pro Smart Printer; Na cívce; Flexibilní, 5–5,2 mm; Bez potisku; Možnost naklapnutí; Žlutá	<a href="http://www.wago.com/2009-115/000-002">www.wago.com/2009-115/000-002</a>

	<b>Obj. č.: 2009-115/000-006</b> WMB Inline; Pro Smart Printer; Na cívce; Flexibilní, 5–5,2 mm; Bez potisku; Možnost naklapnutí; Modrá	<a href="http://www.wago.com/2009-115/000-006">www.wago.com/2009-115/000-006</a>
	<b>Obj. č.: 2009-115/000-007</b> WMB Inline; Pro Smart Printer; Na cívce; Flexibilní, 5–5,2 mm; Bez potisku; Možnost naklapnutí; Šedá	<a href="http://www.wago.com/2009-115/000-007">www.wago.com/2009-115/000-007</a>
	<b>Obj. č.: 2009-115/000-012</b> WMB Inline; Pro Smart Printer; Na cívce; Flexibilní, 5–5,2 mm; Bez potisku; Možnost naklapnutí; Oranžová	<a href="http://www.wago.com/2009-115/000-012">www.wago.com/2009-115/000-012</a>
	<b>Obj. č.: 2009-115/000-017</b> WMB Inline; Pro Smart Printer; Na cívce; Flexibilní, 5–5,2 mm; Bez potisku; Možnost naklapnutí; Světle zelená	<a href="http://www.wago.com/2009-115/000-017">www.wago.com/2009-115/000-017</a>
	<b>Obj. č.: 2009-115/000-023</b> WMB Inline; Pro Smart Printer; Na cívce; Flexibilní, 5–5,2 mm; Bez potisku; Možnost naklapnutí; Zelená	<a href="http://www.wago.com/2009-115/000-023">www.wago.com/2009-115/000-023</a>
	<b>Obj. č.: 2009-115/000-024</b> WMB Inline; Pro Smart Printer; Na cívce; Flexibilní, 5–5,2 mm; Bez potisku; Možnost naklapnutí; Fialová	<a href="http://www.wago.com/2009-115/000-024">www.wago.com/2009-115/000-024</a>
	<b>Obj. č.: 793-501</b> Popisovací karta WMB; Jako karta; Neflexibilní; Bez potisku; Možnost naklapnutí; Bílá	<a href="http://www.wago.com/793-501">www.wago.com/793-501</a>
	<b>Obj. č.: 793-501/000-002</b> Popisovací karta WMB; Jako karta; Neflexibilní; Bez potisku; Možnost naklapnutí; Bílá	<a href="http://www.wago.com/793-501/000-002">www.wago.com/793-501/000-002</a>
	<b>Obj. č.: 793-501/000-005</b> Popisovací karta WMB; Jako karta; Neflexibilní; Bez potisku; Možnost naklapnutí; Červená	<a href="http://www.wago.com/793-501/000-005">www.wago.com/793-501/000-005</a>
	<b>Obj. č.: 793-501/000-006</b> Popisovací karta WMB; Jako karta; Neflexibilní; Bez potisku; Možnost naklapnutí; Modrá	<a href="http://www.wago.com/793-501/000-006">www.wago.com/793-501/000-006</a>
	<b>Obj. č.: 793-501/000-007</b> Popisovací karta WMB; Jako karta; Neflexibilní; Bez potisku; Možnost naklapnutí; Šedá	<a href="http://www.wago.com/793-501/000-007">www.wago.com/793-501/000-007</a>
	<b>Obj. č.: 793-501/000-012</b> Popisovací karta WMB; Jako karta; Neflexibilní; Bez potisku; Možnost naklapnutí; Oranžová	<a href="http://www.wago.com/793-501/000-012">www.wago.com/793-501/000-012</a>
	<b>Obj. č.: 793-501/000-017</b> Popisovací karta WMB; Jako karta; Neflexibilní; Bez potisku; Možnost naklapnutí; Světle zelená	<a href="http://www.wago.com/793-501/000-017">www.wago.com/793-501/000-017</a>
	<b>Obj. č.: 793-501/000-023</b> Popisovací karta WMB; Jako karta; Neflexibilní; Bez potisku; Možnost naklapnutí; Zelená	<a href="http://www.wago.com/793-501/000-023">www.wago.com/793-501/000-023</a>
	<b>Obj. č.: 793-501/000-024</b> Popisovací karta WMB; Jako karta; Neflexibilní; Bez potisku; Možnost naklapnutí; Fialová	<a href="http://www.wago.com/793-501/000-024">www.wago.com/793-501/000-024</a>

	<b>Obj. č.: 793-5501</b> Popisovací karta WMB; Jako karta; Pro svorky o šířce 5–17,5 mm; Flexibilní, 5–5,2 mm; Bez potisku; Možnost naklapnutí; Bílá	<a href="http://www.wago.com/793-5501">www.wago.com/793-5501</a>
	<b>Obj. č.: 793-5501/000-002</b> Popisovací karta WMB; Jako karta; Pro svorky o šířce 5–17,5 mm; Flexibilní, 5–5,2 mm; Bez potisku; Možnost naklapnutí; Žlutá	<a href="http://www.wago.com/793-5501/000-002">www.wago.com/793-5501/000-002</a>
	<b>Obj. č.: 793-5501/000-005</b> Popisovací karta WMB; Jako karta; Flexibilní, 5–5,2 mm; Bez potisku; Možnost naklapnutí; Červená	<a href="http://www.wago.com/793-5501/000-005">www.wago.com/793-5501/000-005</a>
	<b>Obj. č.: 793-5501/000-006</b> Popisovací karta WMB; Jako karta; Flexibilní, 5–5,2 mm; Bez potisku; Možnost naklapnutí; Modrá	<a href="http://www.wago.com/793-5501/000-006">www.wago.com/793-5501/000-006</a>
	<b>Obj. č.: 793-5501/000-007</b> Popisovací karta WMB; Jako karta; Flexibilní, 5–5,2 mm; Bez potisku; Možnost naklapnutí; Šedá	<a href="http://www.wago.com/793-5501/000-007">www.wago.com/793-5501/000-007</a>
	<b>Obj. č.: 793-5501/000-012</b> Popisovací karta WMB; Jako karta; Flexibilní, 5–5,2 mm; Bez potisku; Možnost naklapnutí; Oranžová	<a href="http://www.wago.com/793-5501/000-012">www.wago.com/793-5501/000-012</a>
	<b>Obj. č.: 793-5501/000-017</b> Popisovací karta WMB; Jako karta; Flexibilní, 5–5,2 mm; Bez potisku; Možnost naklapnutí; Světle zelená	<a href="http://www.wago.com/793-5501/000-017">www.wago.com/793-5501/000-017</a>
	<b>Obj. č.: 793-5501/000-023</b> Popisovací karta WMB; Jako karta; Flexibilní, 5–5,2 mm; Bez potisku; Možnost naklapnutí; Zelená	<a href="http://www.wago.com/793-5501/000-023">www.wago.com/793-5501/000-023</a>
	<b>Obj. č.: 793-5501/000-024</b> Popisovací karta WMB; Jako karta; Flexibilní, 5–5,2 mm; Bez potisku; Možnost naklapnutí; Fialová	<a href="http://www.wago.com/793-5501/000-024">www.wago.com/793-5501/000-024</a>
<b>ferrule</b>		
	<b>Obj. č.: 216-101</b> Dutinka; Objímka na 0,5 mm <sup>2</sup> / AWG 22; Bez plastového límce; Galvanicky pocínováno	<a href="http://www.wago.com/216-101">www.wago.com/216-101</a>
	<b>Obj. č.: 216-102</b> Dutinka; Objímka na 0,75 mm <sup>2</sup> / AWG 20; Bez plastového límce; Galvanicky pocínováno	<a href="http://www.wago.com/216-102">www.wago.com/216-102</a>
	<b>Obj. č.: 216-103</b> Dutinka; Objímka na 1 mm <sup>2</sup> / AWG 18; Bez plastového límce; Galvanicky pocínováno	<a href="http://www.wago.com/216-103">www.wago.com/216-103</a>
	<b>Obj. č.: 216-104</b> Dutinka; Objímka na 1,5 mm <sup>2</sup> / AWG 16; Bez plastového límce; Galvanicky pocínováno	<a href="http://www.wago.com/216-104">www.wago.com/216-104</a>
	<b>Obj. č.: 216-201</b> Ferrule; Sleeve for 0.5 mm <sup>2</sup> / 20 AWG; insulated; electro-tin plated; white	<a href="http://www.wago.com/216-201">www.wago.com/216-201</a>
	<b>Obj. č.: 216-202</b> Ferrule; Sleeve for 0.75 mm <sup>2</sup> / 18 AWG; insulated; electro-tin plated; gray	<a href="http://www.wago.com/216-202">www.wago.com/216-202</a>
	<b>Obj. č.: 216-203</b> Dutinka; Objímka na 1 mm <sup>2</sup> / AWG 18; S plastovým límcem; Galvanicky pocínováno; Červená	<a href="http://www.wago.com/216-203">www.wago.com/216-203</a>
	<b>Obj. č.: 216-204</b>	

	Dutinka; Objímka na 1,5 mm <sup>2</sup> / AWG 16; S plastovým límcem; Galvanicky pocínováno; Černá	<a href="http://www.wago.com/216-204">www.wago.com/216-204</a>
	<b>Obj. č.: 216-301</b> Dutinka; Objímka na 0,25 mm <sup>2</sup> / AWG 24; S plastovým límcem; Galvanicky pocínováno; Žlutá	<a href="http://www.wago.com/216-301">www.wago.com/216-301</a>
	<b>Obj. č.: 216-302</b> Ferrule; Sleeve for 0.34 mm <sup>2</sup> / 22 AWG; insulated; electro-tin plated; green	<a href="http://www.wago.com/216-302">www.wago.com/216-302</a>
<b>check</b>		
	<b>Obj. č.: 249-141</b> Modul pro zkušební zástrčku L; Možnost řadového připojení; S pružnou kontaktní vidlicí; Středový modul; 1,50 mm <sup>2</sup> ; Šedá	<a href="http://www.wago.com/249-141">www.wago.com/249-141</a>
<b>assembling</b>		
	<b>Obj. č.: 209-106</b> Držák; K izolované montáži nosných lišt DIN 35; Šedá	<a href="http://www.wago.com/209-106">www.wago.com/209-106</a>
	<b>Obj. č.: 709-154</b> Krycí profil; Typ 2; Vhodný pro držák krycího profilu typu 2; Délka 1 m; Transparentní	<a href="http://www.wago.com/709-154">www.wago.com/709-154</a>
<b>Insulation stop</b>		
	<b>Obj. č.: 280-470</b> Izolační zarážka; 0,08–0,2 mm <sup>2</sup> „e“ (0,14 mm <sup>2</sup> „f“); 5 ks/pás; Bílá	<a href="http://www.wago.com/280-470">www.wago.com/280-470</a>
	<b>Obj. č.: 280-471</b> Izolační zarážka; 0,25–0,5 mm <sup>2</sup> ; 5 ks/pás; Světle šedá	<a href="http://www.wago.com/280-471">www.wago.com/280-471</a>
	<b>Obj. č.: 280-472</b> Izolační zarážka; 0,75–1 mm <sup>2</sup> ; 5 ks/pás	<a href="http://www.wago.com/280-472">www.wago.com/280-472</a>

## Ke stažení

### Documentation

#### Additional Information

Technical explanations	03-Apr-2019	pdf 2,1 MB	Stáhnout
------------------------	-------------	---------------	----------

### CAD/CAE-Data

#### CAD data

2D/3D Models 280-537	URL	Stáhnout
----------------------	-----	----------

#### CAE data

EPLAN Data Portal 280-537	Stáhnout
---------------------------	----------

WSCAD Universe 280-537	Stáhnout
------------------------	----------

## Handling Instructions

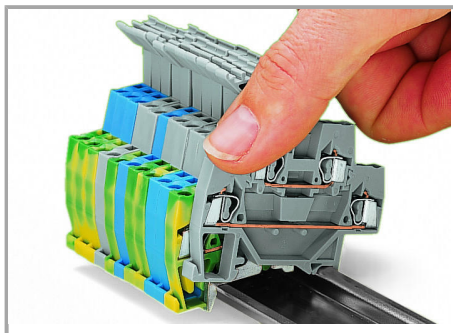

Snapping a terminal block onto the carrier rail.

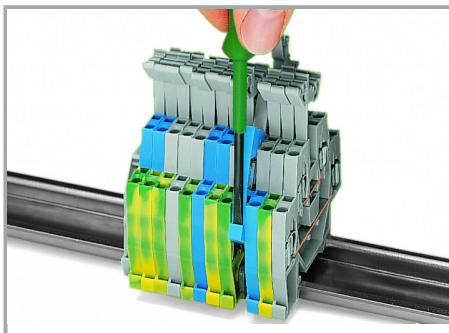

Removing a terminal block from the assembly.

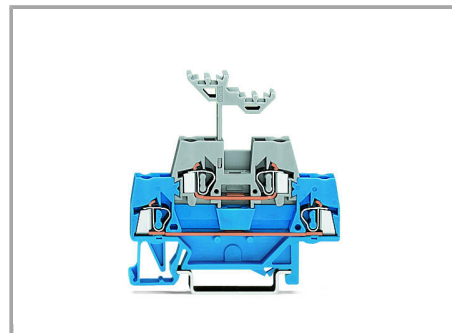

Double-deck terminal blocks accommodate two circuits of different potentials on two decks; different circuits can be differentiated by color coding either deck (280 Series). The lower deck is wider than the upper for ease of wiring.

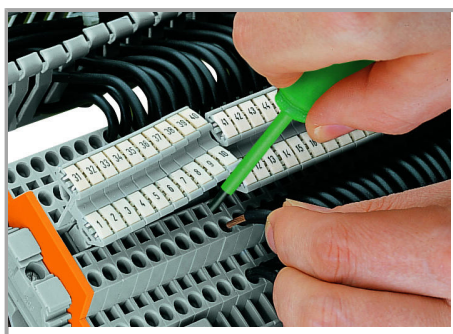

The flexible marker carrier, which is placed above the wiring level, can be pushed aside during wiring or commoning. The carrier has two staggered levels for WMB markers that perfectly align with the terminal block decks.

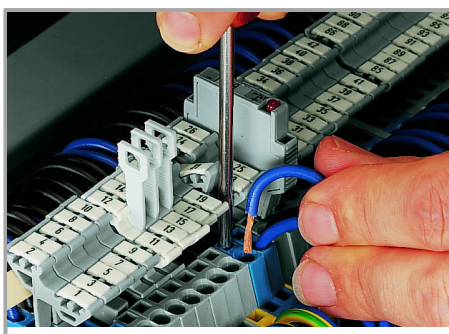

Změny vyhrazeny.

WAGO Elektro spol. sr. o.  
Rozvodova 1116/36  
143 00 Praha 12 - Modřany  
Tel.: +420 261 090 143  
Email: [info.cz@wago.com](mailto:info.cz@wago.com), [wago-cz@wago.com](mailto:wago-cz@wago.com)

Máte otázky ohledně našich produktů?  
Kdykoli nám zavolejte na číslo +420 261 090 143.

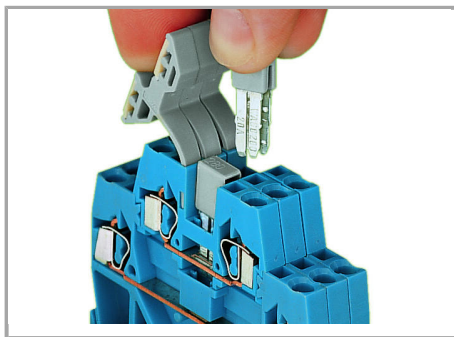

Commoning using an adjacent jumper (280-402).

Push jumper down until fully inserted.

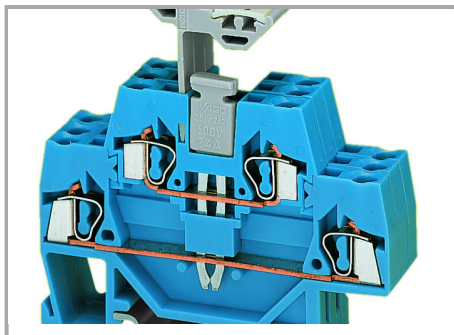

Commoning with a vertical jumper (281-421).



Combining vertical and adjacent jumpers.

Push vertical jumper down until fully inserted.

Změny vyhrazeny.

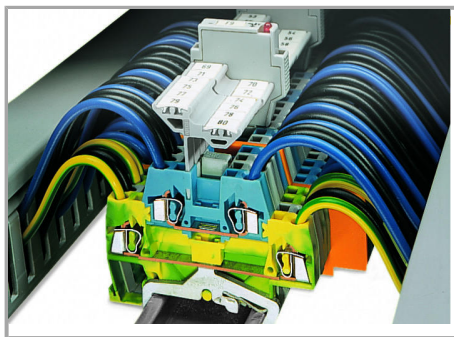

Example of a mixed assembly with double-deck terminal blocks.

The 280 Series Double-Deck Terminal Blocks are available with decks of same or different color according to their function. This is an additional visual aid during wiring, service or maintenance.

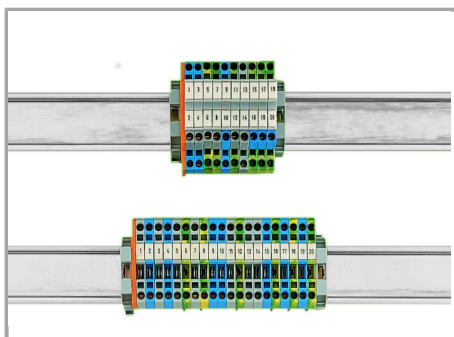

Save 50 % of rail space via double-deck terminal blocks.

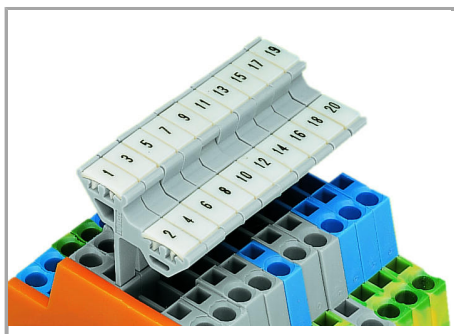

Labeling via WMB Multi Marking System.  
Změny vyhrazeny.