

Datový list | Objednací číslo: 280-532

Dvoupatrová svorka; S dodatečným příčným můstkovým propojením na prvním patře; Na DIN lištu 35 × 15 a 35 × 7,5; 2,5 mm²; CAGE CLAMP®; 2,50 mm²; Modrá/šedá

www.wago.com/280-532

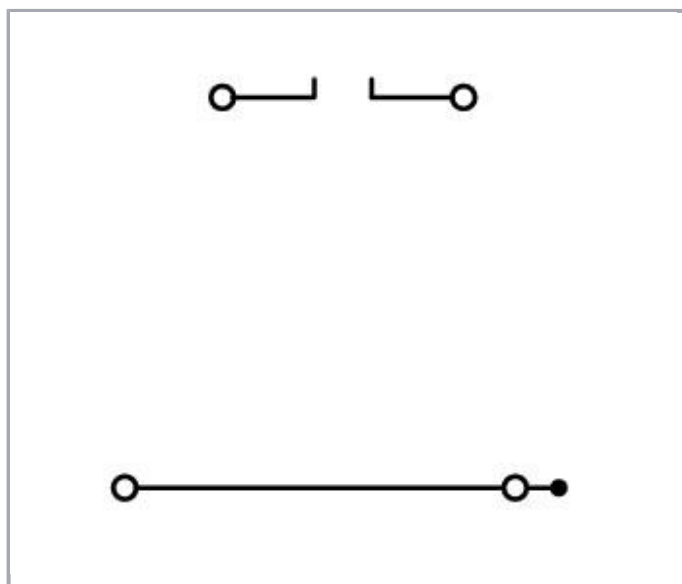
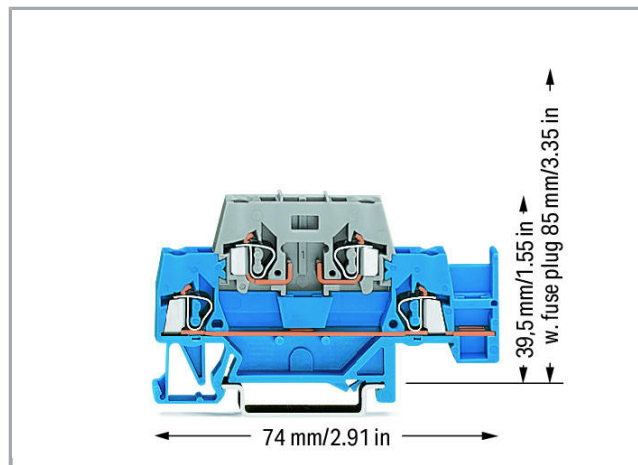
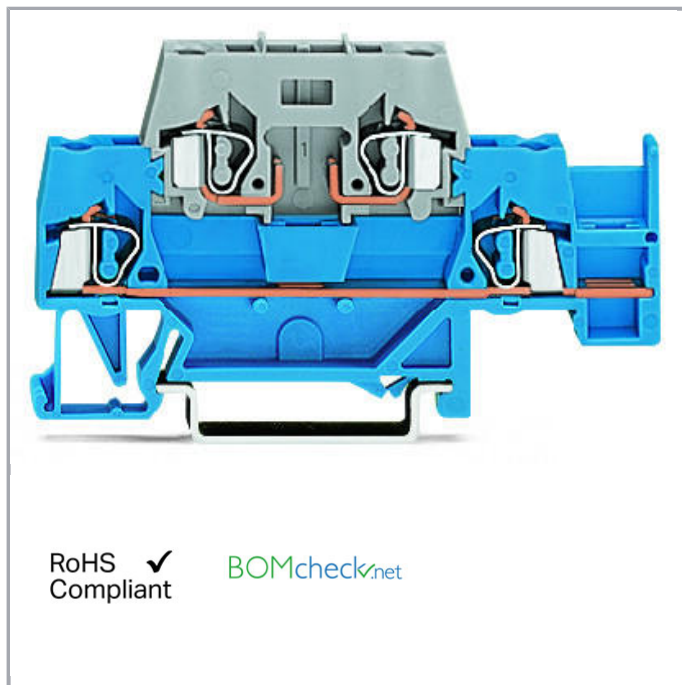

Popis položky

Upozornění:

Terminating Aluminum Conductors

WAGO spring clamp terminal blocks are suitable for solid aluminum conductors up to 4 mm²/12 AWG if WAGO "Alu-Plus" Contact Paste is used for termination.



"Alu-Plus" Contact Paste Advantages:

- Automatically destroys the oxide film during clamping.
- Prevents fresh oxidation at the clamping point.
- Prevents electrolytic corrosion between aluminum and copper conductors (in the same terminal block).
- Provides long-term protection against corrosion.

Using terminal blocks with CAGE CLAMP® Spring Pressure Connection Technology, aluminum conductors must first be cleaned with a blade and then immediately be inserted into the clamping units filled with "Alu-Plus" Contact Paste.

It is also possible to apply WAGO "Alu-Plus" **additionally** on the whole surface of the aluminum conductor before termination.

Please note that the nominal currents must be adapted to the reduced conductivity of the aluminum conductors:

2.5 mm² (14 AWG) = 16 A

4 mm² (12 AWG) = 22 A

Data

Elektrické parametry

Ratings per IEC/EN 60664-1

Návrhové napětí (III / 3)	400 V
Návrhové rázové napětí (III / 3)	6 kV
Jmenovitý proud	10 A
Jmenovitý proud (2)	20 A
Legenda (návrhové hodnoty)	(III / 3) ≙ kategorie přepětí III / stupeň znečištění 3

Údaje o připojení

Připojovací technika	CAGE CLAMP®
Způsob ovládání	Ovládací nástroj
Materiály připojitelných vodičů	Měď Hliník
Plný vodič	0,08 ... 2,5 mm ² / 28 ... 12 AWG
Jemně laněný vodič	0,08 ... 2,5 mm ² / 28 ... 12 AWG
Délka odizolování	8 ... 9 mm / 0.31 ... 0.35 palec
Celkový počet kontaktních míst	4
Celkový počet potenciálů	2
Počet úrovní	2
Způsob zapojení	čelní připojení
Upozornění (průřez vodiče)	12 AWG: THHN, THWN

Geometrické údaje

Šířka	5 mm / 0.197 inch
Výška od horní hrany lišty DIN 35	39,5 mm / 1.555 inch
Hloubka	74 mm / 2.913 inch

Mechanické parametry

Provedení	Horizontální provedení
Způsob montáže	Lišta DIN 35
Úroveň popisování	Bez úrovně popisování

Údaje o materiálu



barva	Modrá/šedá
Izolační materiál	Polyamid 66 (PA 66)
Požární zatížení	0.156 MJ
Hmotnost	9.68 g

Obchodní údaje

Product Group	1 (Rail Mounted Terminal Blocks)
Druh balení	BOX
Country of origin	CN
GTIN	4050821293682
Customs Tariff No.	85369010000

Atesty/certifikáty

Specifické atesty jednotlivých států

Logo	Schválení	Doplňkový text schválení	Název certifikátu
	CCA DEKRA Certification B.V.	EN 60947	2157201.01
	CSA DEKRA Certification B.V.	C22.2	1536071

Atesty pro použití v lodním průmyslu

Logo	Schválení	Doplňkový text schválení	Název certifikátu
	ABS American Bureau of Shipping	EN 60947	14- HG1293677-



BUREAU
VERITAS

BV
Bureau Veritas S.A.

EN 60947

07436/E0
BV



LR
Lloyds Register

EN 60947





91/20112
(E9)















Atesty UL















Logo	Schválení	Doplňkový text schválení	Název certifikátu
	UR Underwriters Laboratories Inc.	UL 1059	20190731- E45172















Kompatibilní produkty

Female plug















	Obj. č.: 232-132/005-000 Female connector for rail-mount terminal blocks; Rovné provedení; Rozteč 5 mm; 2pól.; Šedá	www.wago.com/232-132/005-000
	Obj. č.: 232-132/005-000/039-000 Female connector for rail-mount terminal blocks; straight; Locking lever; Pin spacing 5 mm; 3-pole; gray	www.wago.com/232-132/005-000/039-000
	Obj. č.: 232-133/005-000 Female connector for rail-mount terminal blocks; Rovné provedení; Rozteč 5 mm; 3pól.; Šedá	www.wago.com/232-133/005-000
	Obj. č.: 232-133/005-000/039-000 Female connector for rail-mount terminal blocks; Rovné provedení; Blokovací západka; Rozteč 5 mm; 3pól.; Šedá	www.wago.com/232-133/005-000/039-000

	Obj. č.: 232-134/005-000 Female connector for rail-mount terminal blocks; Rovné provedení; Rozteč 5 mm; 4pól.; Šedá	www.wago.com/232-134/005-000
	Obj. č.: 232-134/005-000/039-000 Female connector for rail-mount terminal blocks; Rovné provedení; Blokovací západka; Rozteč 5 mm; 4pól.; Šedá	www.wago.com/232-134/005-000/039-000
	Obj. č.: 232-135/005-000 Female connector for rail-mount terminal blocks; Rovné provedení; Rozteč 5 mm; 5pól.; Šedá	www.wago.com/232-135/005-000
	Obj. č.: 232-135/005-000/039-000 Female connector for rail-mount terminal blocks; Rovné provedení; Blokovací západka; Rozteč 5 mm; 5pól.; Šedá	www.wago.com/232-135/005-000/039-000
	Obj. č.: 232-136/005-000 Female connector for rail-mount terminal blocks; Rovné provedení; Rozteč 5 mm; 6pól.; Šedá	www.wago.com/232-136/005-000
	Obj. č.: 232-136/005-000/039-000 Female connector for rail-mount terminal blocks; Rovné provedení; Blokovací západka; Rozteč 5 mm; 6pól.; Šedá	www.wago.com/232-136/005-000/039-000
	Obj. č.: 232-137/005-000 Female connector for rail-mount terminal blocks; Rovné provedení; Rozteč 5 mm; 7pól.; Šedá	www.wago.com/232-137/005-000
	Obj. č.: 232-137/005-000/039-000 Female connector for rail-mount terminal blocks; Rovné provedení; Blokovací západka; Rozteč 5 mm; 7pól.; Šedá	www.wago.com/232-137/005-000/039-000
	Obj. č.: 232-138/005-000 Female connector for rail-mount terminal blocks; Rovné provedení; Rozteč 5 mm; 8pól.; Šedá	www.wago.com/232-138/005-000
	Obj. č.: 232-138/005-000/039-000 Female connector for rail-mount terminal blocks; Rovné provedení; Blokovací západka; Rozteč 5 mm; 8pól.; Šedá	www.wago.com/232-138/005-000/039-000
	Obj. č.: 232-139/005-000 Female connector for rail-mount terminal blocks; Rovné provedení; Rozteč 5 mm; 9pól.; Šedá	www.wago.com/232-139/005-000
	Obj. č.: 232-139/005-000/039-000 Female connector for rail-mount terminal blocks; Rovné provedení; Blokovací západka; Rozteč 5 mm; 9pól.; Šedá	www.wago.com/232-139/005-000/039-000
	Obj. č.: 232-140/005-000 Female connector for rail-mount terminal blocks; Rovné provedení; Rozteč 5 mm; 10pól.; Šedá	www.wago.com/232-140/005-000
	Obj. č.: 232-140/005-000/039-000 Female connector for rail-mount terminal blocks; Rovné provedení; Blokovací západka; Rozteč 5 mm; 10pól.; Šedá	www.wago.com/232-140/005-000/039-000

	Obj. č.: 232-142/005-000 Female connector for rail-mount terminal blocks; Rovné provedení; Rozteč 5 mm; 12pól.; Šedá	www.wago.com/232-142/005-000
	Obj. č.: 232-142/005-000/039-000 Female connector for rail-mount terminal blocks; Rovné provedení; Blokovací západka; Rozteč 5 mm; 12pól.; Šedá	www.wago.com/232-142/005-000/039-000
	Obj. č.: 232-146/005-000 Female connector for rail-mount terminal blocks; Rovné provedení; Rozteč 5 mm; 16pól.; Šedá	www.wago.com/232-146/005-000
	Obj. č.: 232-146/005-000/039-000 Female connector for rail-mount terminal blocks; Rovné provedení; Blokovací západka; Rozteč 5 mm; 16pól.; Šedá	www.wago.com/232-146/005-000/039-000
	Obj. č.: 232-147/005-000/039-000 Female connector for rail-mount terminal blocks; straight; Locking lever; Pin spacing 5 mm; 17-pole; gray	www.wago.com/232-147/005-000/039-000
	Obj. č.: 232-150/005-000 Female connector for rail-mount terminal blocks; Rovné provedení; Rozteč 5 mm; 20pól.; Šedá	www.wago.com/232-150/005-000
	Obj. č.: 232-150/005-000/039-000 Female connector for rail-mount terminal blocks; straight; Locking lever; Pin spacing 5 mm; 20-pole; gray	www.wago.com/232-150/005-000/039-000
	Obj. č.: 232-232/005-000 Female connector for rail-mount terminal blocks; Úhlové provedení; Rozteč 5 mm; 2pól.; Šedá	www.wago.com/232-232/005-000
	Obj. č.: 232-232/005-000/039-000 Female connector for rail-mount terminal blocks; Úhlové provedení; Blokovací západka; Rozteč 5 mm; 2pól.; Šedá	www.wago.com/232-232/005-000/039-000
	Obj. č.: 232-233/005-000 Female connector for rail-mount terminal blocks; Úhlové provedení; Rozteč 5 mm; 3pól.; Šedá	www.wago.com/232-233/005-000
	Obj. č.: 232-233/005-000/039-000 Female connector for rail-mount terminal blocks; angled; Locking lever; Pin spacing 5 mm; 3-pole; gray	www.wago.com/232-233/005-000/039-000
	Obj. č.: 232-234/005-000 Female connector for rail-mount terminal blocks; Úhlové provedení; Rozteč 5 mm; 4pól.; Šedá	www.wago.com/232-234/005-000
	Obj. č.: 232-234/005-000/039-000 Female connector for rail-mount terminal blocks; Úhlové provedení; Blokovací západka; Rozteč 5 mm; 4pól.; Šedá	www.wago.com/232-234/005-000/039-000
	Obj. č.: 232-235/005-000 Female connector for rail-mount terminal blocks; Úhlové provedení; Rozteč 5 mm; 5pól.; Šedá	www.wago.com/232-235/005-000
	Obj. č.: 232-235/005-000/039-000 Female connector for rail-mount terminal blocks; Úhlové provedení; Blokovací západka; Rozteč 5 mm; 5pól.; Šedá	

	mm; 5pól.; Šedá	www.wago.com/232-235/005-000/039-000
	Obj. č.: 232-236/005-000 Female connector for rail-mount terminal blocks; Úhlové provedení; Rozteč 5 mm; 6pól.; Šedá	www.wago.com/232-236/005-000
	Obj. č.: 232-236/005-000/039-000 Female connector for rail-mount terminal blocks; angled; Locking lever; Pin spacing 5 mm; 6-pole; gray	www.wago.com/232-236/005-000/039-000
	Obj. č.: 232-237/005-000 Female connector for rail-mount terminal blocks; Úhlové provedení; Rozteč 5 mm; 7pól.; Šedá	www.wago.com/232-237/005-000
	Obj. č.: 232-238/005-000 Female connector for rail-mount terminal blocks; Úhlové provedení; Rozteč 5 mm; 8pól.; Šedá	www.wago.com/232-238/005-000
	Obj. č.: 232-239/005-000 Female connector for rail-mount terminal blocks; Úhlové provedení; Rozteč 5 mm; 9pól.; Šedá	www.wago.com/232-239/005-000
	Obj. č.: 232-240/005-000 Female connector for rail-mount terminal blocks; Úhlové provedení; Rozteč 5 mm; 10pól.; Šedá	www.wago.com/232-240/005-000
	Obj. č.: 232-240/005-000/039-000 Female connector for rail-mount terminal blocks; Úhlové provedení; Blokovací západka; Rozteč 5 mm; 10pól.; Šedá	www.wago.com/232-240/005-000/039-000
	Obj. č.: 232-242/005-000 Female connector for rail-mount terminal blocks; Úhlové provedení; Rozteč 5 mm; 12pól.; Šedá	www.wago.com/232-242/005-000
	Obj. č.: 232-242/005-000/039-000 Female connector for rail-mount terminal blocks; Úhlové provedení; Blokovací západka; Rozteč 5 mm; 12pól.; Šedá	www.wago.com/232-242/005-000/039-000
	Obj. č.: 232-246/005-000 Female connector for rail-mount terminal blocks; Úhlové provedení; Rozteč 5 mm; 16pól.; Šedá	www.wago.com/232-246/005-000
	Obj. č.: 232-246/005-000/039-000 Female connector for rail-mount terminal blocks; Úhlové provedení; Blokovací západka; Rozteč 5 mm; 16pól.; Šedá	www.wago.com/232-246/005-000/039-000
	Obj. č.: 232-250/005-000 Female connector for rail-mount terminal blocks; Úhlové provedení; Rozteč 5 mm; 20pól.; Šedá	www.wago.com/232-250/005-000
	Obj. č.: 232-250/005-000/039-000 Female connector for rail-mount terminal blocks; angled; Locking lever; Pin spacing 5 mm; 20-pole; gray	www.wago.com/232-250/005-000/039-000
	Obj. č.: 232-732/005-000 Female connector for rail-mount terminal blocks; Rovné provedení; Rozteč 7,5 mm; 2pól.; Šedá	www.wago.com/232-732/005-000



	Obj. č.: 232-733/005-000 Female connector for rail-mount terminal blocks; Rovné provedení; Rozteč 7,5 mm; 3pól.; Šedá	www.wago.com/232-733/005-000
	Obj. č.: 232-734/005-000 Female connector for rail-mount terminal blocks; Rovné provedení; Rozteč 7,5 mm; 4pól.; Šedá	www.wago.com/232-734/005-000
	Obj. č.: 232-734/005-000/039-000 Female connector for rail-mount terminal blocks; Rovné provedení; Rozteč 7,5 mm; 4pól.; Šedá	www.wago.com/232-734/005-000/039-000
	Obj. č.: 232-735/005-000 Female connector for rail-mount terminal blocks; Rovné provedení; Rozteč 7,5 mm; 5pól.; Šedá	www.wago.com/232-735/005-000
	Obj. č.: 232-735/005-000/039-000 Female connector for rail-mount terminal blocks; Rovné provedení; Rozteč 7,5 mm; 5pól.; Šedá	www.wago.com/232-735/005-000/039-000
	Obj. č.: 232-736/005-000 Female connector for rail-mount terminal blocks; Rovné provedení; Rozteč 7,5 mm; 6pól.; Šedá	www.wago.com/232-736/005-000
	Obj. č.: 232-736/005-000/039-000 Female connector for rail-mount terminal blocks; Rovné provedení; Rozteč 7,5 mm; 6pól.; Šedá	www.wago.com/232-736/005-000/039-000
	Obj. č.: 232-738/005-000 Female connector for rail-mount terminal blocks; Rovné provedení; Rozteč 7,5 mm; 8pól.; Šedá	www.wago.com/232-738/005-000
	Obj. č.: 232-740/005-000 Female connector for rail-mount terminal blocks; Rovné provedení; Rozteč 7,5 mm; 10pól.; Šedá	www.wago.com/232-740/005-000
	Obj. č.: 232-742/005-000 Female connector for rail-mount terminal blocks; Rovné provedení; Rozteč 7,5 mm; 12pól.; Šedá	www.wago.com/232-742/005-000
	Obj. č.: 232-832/005-000 Pružinová svorkovnice THT; 0,6 x 1,0 mm solder pin; Úhlové provedení; Rozteč 7,5 mm; 2pól.; Šedá	www.wago.com/232-832/005-000
	Obj. č.: 232-833/005-000 Pružinová svorkovnice THT; 0,6 x 1,0 mm solder pin; Úhlové provedení; Rozteč 7,5 mm; 3pól.; Šedá	www.wago.com/232-833/005-000
	Obj. č.: 232-834/005-000 Pružinová svorkovnice THT; 0,6 x 1,0 mm solder pin; Úhlové provedení; Rozteč 7,5 mm; 4pól.; Šedá	www.wago.com/232-834/005-000
	Obj. č.: 232-836/005-000 Pružinová svorkovnice THT; 0,6 x 1,0 mm solder pin; Úhlové provedení; Rozteč 7,5 mm; 6pól.; Šedá	www.wago.com/232-836/005-000

**Obj. č.: 232-836/005-000/039-000**

Pružinová svorkovnice THT; 0.6 x 1.0 mm solder pin; Úhlové provedení; Blokovací západka; Rozteč 7,5 mm; 6pól.; Šedá

www.wago.com/232-836/005-000/039-000**Obj. č.: 232-840/005-000**

Pružinová svorkovnice THT; 0.6 x 1.0 mm solder pin; Úhlové provedení; Rozteč 7,5 mm; 10pól.; Šedá

www.wago.com/232-840/005-000**Obj. č.: 232-842/005-000**

THT female header; 0.6 x 1.0 mm solder pin; angled; Pin spacing 7.5 mm; 12-pole; gray

www.wago.com/232-842/005-000**Obj. č.: 722-132/005-000**

Female connector for rail-mount terminal blocks; Rovné provedení; 100% ochrana proti chybnému zapojení; Rozteč 5 mm; 2pól.; Světle šedá

www.wago.com/722-132/005-000**Obj. č.: 722-132/005-000/039-000**

Female connector for rail-mount terminal blocks; Rovné provedení; 100% ochrana proti chybnému zapojení; Blokovací západka; Rozteč 5 mm; 3pól.; Světle šedá

www.wago.com/722-132/005-000/039-000**Obj. č.: 722-133/005-000**

Female connector for rail-mount terminal blocks; Rovné provedení; 100% ochrana proti chybnému zapojení; Rozteč 5 mm; 3pól.; Světle šedá

www.wago.com/722-133/005-000**Obj. č.: 722-133/005-000/039-000**

Female connector for rail-mount terminal blocks; Rovné provedení; 100% ochrana proti chybnému zapojení; Blokovací západka; Rozteč 5 mm; 3pól.; Světle šedá

www.wago.com/722-133/005-000/039-000**Obj. č.: 722-134/005-000**

Female connector for rail-mount terminal blocks; Rovné provedení; 100% ochrana proti chybnému zapojení; Rozteč 5 mm; 4pól.; Světle šedá

www.wago.com/722-134/005-000**Obj. č.: 722-134/005-000/039-000**

Female connector for rail-mount terminal blocks; Rovné provedení; 100% ochrana proti chybnému zapojení; Blokovací západka; Rozteč 5 mm; 4pól.; Světle šedá

www.wago.com/722-134/005-000/039-000**Obj. č.: 722-135/005-000**

Female connector for rail-mount terminal blocks; Rovné provedení; 100% ochrana proti chybnému zapojení; Rozteč 5 mm; 5pól.; Světle šedá

www.wago.com/722-135/005-000**Obj. č.: 722-135/005-000/039-000**

Female connector for rail-mount terminal blocks; Rovné provedení; 100% ochrana proti chybnému zapojení; Blokovací západka; Rozteč 5 mm; 5pól.; Světle šedá

www.wago.com/722-135/005-000/039-000**Obj. č.: 722-136/005-000**

Female connector for rail-mount terminal blocks; Rovné provedení; 100% ochrana proti chybnému zapojení; Rozteč 5 mm; 6pól.; Světle šedá

www.wago.com/722-136/005-000**Obj. č.: 722-136/005-000/039-000**

Female connector for rail-mount terminal blocks; Rovné provedení; 100% ochrana proti chybnému zapojení; Blokovací západka; Rozteč 5 mm; 6pól.; Světle šedá

www.wago.com/722-136/005-000/039-000**Obj. č.: 722-137/005-000**

Female connector for rail-mount terminal blocks; Rovné provedení; 100% ochrana proti chybnému zapojení; Rozteč 5 mm; 7pól.; Světle šedá

www.wago.com/722-137/005-000**Obj. č.: 722-137/005-000/039-000**

Female connector for rail-mount terminal blocks; Rovné provedení; 100% ochrana proti chybnému

www.wago.com/722-137/005-000/039-000

zapojení; Blokovací západka; Rozteč 5 mm; 7pól.; Světle šedá



Obj. č.: 722-138/005-000

Female connector for rail-mount terminal blocks; Rovné provedení; 100% ochrana proti chybnému zapojení; Rozteč 5 mm; 8pól.; Světle šedá

www.wago.com/722-138/005-000



Obj. č.: 722-138/005-000/039-000

Female connector for rail-mount terminal blocks; Rovné provedení; 100% ochrana proti chybnému zapojení; Blokovací západka; Rozteč 5 mm; 8pól.; Světle šedá

www.wago.com/722-138/005-000/039-000



Obj. č.: 722-139/005-000

Female connector for rail-mount terminal blocks; Rovné provedení; 100% ochrana proti chybnému zapojení; Rozteč 5 mm; 9pól.; Světle šedá

www.wago.com/722-139/005-000



Obj. č.: 722-139/005-000/039-000

Female connector for rail-mount terminal blocks; Rovné provedení; 100% ochrana proti chybnému zapojení; Blokovací západka; Rozteč 5 mm; 9pól.; Světle šedá

www.wago.com/722-139/005-000/039-000



Obj. č.: 722-140/005-000

Female connector for rail-mount terminal blocks; Rovné provedení; 100% ochrana proti chybnému zapojení; Rozteč 5 mm; 10pól.; Světle šedá

www.wago.com/722-140/005-000



Obj. č.: 722-140/005-000/039-000

Female connector for rail-mount terminal blocks; Rovné provedení; 100% ochrana proti chybnému zapojení; Blokovací západka; Rozteč 5 mm; 10pól.; Světle šedá

www.wago.com/722-140/005-000/039-000



Obj. č.: 722-141/005-000

Female connector for rail-mount terminal blocks; Rovné provedení; 100% ochrana proti chybnému zapojení; Rozteč 5 mm; 11pól.; Světle šedá

www.wago.com/722-141/005-000



Obj. č.: 722-142/005-000

Female connector for rail-mount terminal blocks; Rovné provedení; 100% ochrana proti chybnému zapojení; Rozteč 5 mm; 12pól.; Světle šedá

www.wago.com/722-142/005-000



Obj. č.: 722-142/005-007/039-000

Female connector for rail-mount terminal blocks; Šedá

www.wago.com/722-142/005-007/039-000



Obj. č.: 722-143/005-000

Female connector for rail-mount terminal blocks; Rovné provedení; 100% ochrana proti chybnému zapojení; Rozteč 5 mm; 13pól.; Světle šedá

www.wago.com/722-143/005-000



Obj. č.: 722-144/005-000

Female connector for rail-mount terminal blocks; straight; 100% protected against mismatching; Pin spacing 5 mm; 14-pole; light gray

www.wago.com/722-144/005-000



Obj. č.: 722-144/005-000/039-000

Female connector for rail-mount terminal blocks; Rovné provedení; 100% ochrana proti chybnému zapojení; Blokovací západka; Rozteč 5 mm; 14pól.; Světle šedá

www.wago.com/722-144/005-000/039-000



Obj. č.: 722-145/005-000

Female connector for rail-mount terminal blocks; Rovné provedení; 100% ochrana proti chybnému zapojení; Rozteč 5 mm; 15pól.; Světle šedá

www.wago.com/722-145/005-000































Obj. č.: 722-146/005-000

Female connector for rail-mount terminal blocks; Rovné provedení; 100% ochrana proti chybnému zapojení; Rozteč 5 mm; 16pól.; Světle šedá

www.wago.com/722-146/005-000

Obj. č.: 722-146/005-000/039-000

	Female connector for rail-mount terminal blocks; straight; 100% protected against mismatching; Locking lever; Pin spacing 5 mm; 16-pole; light gray	www.wago.com/722-146/005-000/039-000
	Obj. č.: 722-150/005-000 Female connector for rail-mount terminal blocks; Rovné provedení; 100% ochrana proti chybnému zapojení; Rozteč 5 mm; 20pól.; Světle šedá	www.wago.com/722-150/005-000
	Obj. č.: 722-150/005-000/039-000 Female connector for rail-mount terminal blocks; Rovné provedení; 100% ochrana proti chybnému zapojení; Blokovací západka; Rozteč 5 mm; 20pól.; Světle šedá	www.wago.com/722-150/005-000/039-000
	Obj. č.: 722-232/005-000 Female connector for rail-mount terminal blocks; Úhlové provedení; 100% ochrana proti chybnému zapojení; Rozteč 5 mm; 3pól.; Světle šedá	www.wago.com/722-232/005-000
	Obj. č.: 722-232/005-000/039-000 Female connector for rail-mount terminal blocks; Úhlové provedení; 100% ochrana proti chybnému zapojení; Blokovací západka; Rozteč 5 mm; 3pól.; Světle šedá	www.wago.com/722-232/005-000/039-000
	Obj. č.: 722-233/005-000 Female connector for rail-mount terminal blocks; Úhlové provedení; 100% ochrana proti chybnému zapojení; Rozteč 5 mm; 3pól.; Světle šedá	www.wago.com/722-233/005-000
	Obj. č.: 722-233/005-000/039-000 Female connector for rail-mount terminal blocks; Úhlové provedení; 100% ochrana proti chybnému zapojení; Blokovací západka; Rozteč 5 mm; 3pól.; Světle šedá	www.wago.com/722-233/005-000/039-000
	Obj. č.: 722-234/005-000 Female connector for rail-mount terminal blocks; Úhlové provedení; 100% ochrana proti chybnému zapojení; Rozteč 5 mm; 4pól.; Světle šedá	www.wago.com/722-234/005-000
	Obj. č.: 722-234/005-000/039-000 Female connector for rail-mount terminal blocks; Úhlové provedení; 100% ochrana proti chybnému zapojení; Blokovací západka; Rozteč 5 mm; 4pól.; Světle šedá	www.wago.com/722-234/005-000/039-000
	Obj. č.: 722-235/005-000 Female connector for rail-mount terminal blocks; Úhlové provedení; 100% ochrana proti chybnému zapojení; Rozteč 5 mm; 5pól.; Světle šedá	www.wago.com/722-235/005-000
	Obj. č.: 722-235/005-000/039-000 Female connector for rail-mount terminal blocks; Úhlové provedení; 100% ochrana proti chybnému zapojení; Blokovací západka; Rozteč 5 mm; 5pól.; Světle šedá	www.wago.com/722-235/005-000/039-000
	Obj. č.: 722-236/005-000 Female connector for rail-mount terminal blocks; Úhlové provedení; 100% ochrana proti chybnému zapojení; Rozteč 5 mm; 6pól.; Světle šedá	www.wago.com/722-236/005-000
	Obj. č.: 722-236/005-000/039-000 Female connector for rail-mount terminal blocks; Úhlové provedení; 100% ochrana proti chybnému zapojení; Blokovací západka; Rozteč 5 mm; 6pól.; Světle šedá	www.wago.com/722-236/005-000/039-000
	Obj. č.: 722-237/005-000 Female connector for rail-mount terminal blocks; Úhlové provedení; 100% ochrana proti chybnému zapojení; Rozteč 5 mm; 7pól.; Světle šedá	www.wago.com/722-237/005-000
	Obj. č.: 722-237/005-000/039-000 Female connector for rail-mount terminal blocks; Úhlové provedení; 100% ochrana proti chybnému zapojení; Blokovací západka; Rozteč 5 mm; 7pól.; Světle šedá	www.wago.com/722-237/005-000/039-000

	Obj. č.: 722-238/005-000 Female connector for rail-mount terminal blocks; Úhlové provedení; 100% ochrana proti chybnému zapojení; Rozteč 5 mm; 8pól.; Světle šedá	www.wago.com/722-238/005-000
	Obj. č.: 722-239/005-000 Female connector for rail-mount terminal blocks; Úhlové provedení; 100% ochrana proti chybnému zapojení; Rozteč 5 mm; 9pól.; Světle šedá	www.wago.com/722-239/005-000
	Obj. č.: 722-239/005-000/039-000 Female connector for rail-mount terminal blocks; angled; 100% protected against mismating; Locking lever; Pin spacing 5 mm; 9-pole; light gray	www.wago.com/722-239/005-000/039-000
	Obj. č.: 722-240/005-000 Female connector for rail-mount terminal blocks; Úhlové provedení; 100% ochrana proti chybnému zapojení; Rozteč 5 mm; 10pól.; Světle šedá	www.wago.com/722-240/005-000
	Obj. č.: 722-240/005-000/039-000 Female connector for rail-mount terminal blocks; Úhlové provedení; 100% ochrana proti chybnému zapojení; Blokovací západka; Rozteč 5 mm; 10pól.; Světle šedá	www.wago.com/722-240/005-000/039-000
	Obj. č.: 722-241/005-000 Female connector for rail-mount terminal blocks; Úhlové provedení; 100% ochrana proti chybnému zapojení; Rozteč 5 mm; 11pól.; Světle šedá	www.wago.com/722-241/005-000
	Obj. č.: 722-242/005-000 Female connector for rail-mount terminal blocks; Úhlové provedení; 100% ochrana proti chybnému zapojení; Rozteč 5 mm; 12pól.; Světle šedá	www.wago.com/722-242/005-000
	Obj. č.: 722-242/005-000/039-000 Female connector for rail-mount terminal blocks; angled; 100% protected against mismating; Locking lever; Pin spacing 5 mm; 12-pole; light gray	www.wago.com/722-242/005-000/039-000
	Obj. č.: 722-243/005-000 Female connector for rail-mount terminal blocks; angled; 100% protected against mismating; Pin spacing 5 mm; 13-pole; light gray	www.wago.com/722-243/005-000
	Obj. č.: 722-244/005-000 Female connector for rail-mount terminal blocks; Úhlové provedení; 100% ochrana proti chybnému zapojení; Rozteč 5 mm; 14pól.; Světle šedá	www.wago.com/722-244/005-000
	Obj. č.: 722-244/005-000/039-000 Female connector for rail-mount terminal blocks; Úhlové provedení; 100% ochrana proti chybnému zapojení; Blokovací západka; Rozteč 5 mm; 14pól.; Světle šedá	www.wago.com/722-244/005-000/039-000
	Obj. č.: 722-246/005-000 Female connector for rail-mount terminal blocks; Úhlové provedení; 100% ochrana proti chybnému zapojení; Rozteč 5 mm; 16pól.; Světle šedá	www.wago.com/722-246/005-000
	Obj. č.: 722-246/005-000/039-000 Female connector for rail-mount terminal blocks; Úhlové provedení; 100% ochrana proti chybnému zapojení; Blokovací západka; Rozteč 5 mm; 16pól.; Světle šedá	www.wago.com/722-246/005-000/039-000
	Obj. č.: 722-250/005-000 Female connector for rail-mount terminal blocks; Úhlové provedení; 100% ochrana proti chybnému zapojení; Rozteč 5 mm; 20pól.; Světle šedá	www.wago.com/722-250/005-000

Protective Warning Marker



Obj. č.: 280-415
Výstražný kryt; S černým symbolem blesku; Pro 5 svorek; Žlutá

www.wago.com/280-415

check



Obj. č.: 249-141
Modul pro zkušební zástrčku L; Možnost řadového připojení; S pružnou kontaktní vidlicí; Středový modul; 1,50 mm²; Šedá

www.wago.com/249-141

plug



Obj. č.: 280-850
Pojistkový modul; Se zapájenou miniaturní pojistkou; 250 mA FF; Šířka 5 mm; Šedá

www.wago.com/280-850



Obj. č.: 280-850/281-413
Pojistkový modul; Se zapájenou miniaturní pojistkou; Se světelným indikátorem; Červená LED dioda; DC 15–30 V; 250 mA FF; Šířka 5 mm; Šedá

www.wago.com/280-850/281-413



Obj. č.: 280-850/281-414
Pojistkový modul; Se zapájenou miniaturní pojistkou; Se světelným indikátorem; Červená LED dioda; DC 30–65 V; 250 mA FF; Šířka 5 mm; Šedá

www.wago.com/280-850/281-414



Obj. č.: 280-850/281-415
Pojistkový modul; Se zapájenou miniaturní pojistkou; Se světelným indikátorem; Červená LED dioda; AC 15–30 V; 250 mA FF; Šířka 5 mm; Šedá

www.wago.com/280-850/281-415



Obj. č.: 280-852
Pojistkový modul; Se zapájenou miniaturní pojistkou; 500 mA FF; Šířka 5 mm; Šedá

www.wago.com/280-852



Obj. č.: 280-852/281-413
Pojistkový modul; Se zapájenou miniaturní pojistkou; Se světelným indikátorem; Červená LED dioda; DC 15–30 V; 500 mA FF; Šířka 5 mm; Šedá

www.wago.com/280-852/281-413



Obj. č.: 280-852/281-414
Pojistkový modul; Se zapájenou miniaturní pojistkou; Se světelným indikátorem; Červená LED dioda; DC 30–65 V; 500 mA FF; Šířka 5 mm; Šedá

www.wago.com/280-852/281-414



Obj. č.: 280-852/281-415
Pojistkový modul; Se zapájenou miniaturní pojistkou; Se světelným indikátorem; Červená LED dioda; AC 15–30 V; 500 mA FF; Šířka 5 mm; Šedá

www.wago.com/280-852/281-415



Obj. č.: 280-854
Pojistkový modul; Se zapájenou miniaturní pojistkou; 1 A FF; Šířka 5 mm; Šedá

www.wago.com/280-854



Obj. č.: 280-854/281-413
Pojistkový modul; Se zapájenou miniaturní pojistkou; Se světelným indikátorem; Červená LED dioda; DC 15–30 V; 1 A FF; Šířka 5 mm; Šedá

www.wago.com/280-854/281-413



Obj. č.: 280-854/281-414
Pojistkový modul; Se zapájenou miniaturní pojistkou; Se světelným indikátorem; Červená LED dioda; DC 30–65 V; 1 A FF; Šířka 5 mm; Šedá

www.wago.com/280-854/281-414



Obj. č.: 280-854/281-415
Fuse plug; with soldered miniature fuse; with indicator lamp; LED (red); AC 15 - 30 V; 1 A FF; 5 mm wide; gray

www.wago.com/280-854/281-415



Obj. č.: 280-856
Pojistkový modul; Se zapájenou miniaturní pojistkou; 2 A FF; Šířka 5 mm; Šedá

www.wago.com/280-856

Obj. č.: 280-856/281-413



Pojistkový modul; Se zapájenou miniaturní pojistkou; Se světelným indikátorem; Červená LED dioda; DC 15–30 V; 2 A FF; Šířka 5 mm; Šedá

www.wago.com/280-856/281-413



Obj. č.: 280-856/281-414

Pojistkový modul; Se zapájenou miniaturní pojistkou; Se světelným indikátorem; Červená LED dioda; DC 30–65 V; 2 A FF; Šířka 5 mm; Šedá

www.wago.com/280-856/281-414



Obj. č.: 280-856/281-415

Pojistkový modul; Se zapájenou miniaturní pojistkou; Se světelným indikátorem; Červená LED dioda; AC 15–30 V; 2 A FF; Šířka 5 mm; Šedá

www.wago.com/280-856/281-415

Carrier rail



Obj. č.: 210-112

Ocelová nosná lišta; 35 × 7,5 mm; Tloušťka 1 mm; Délka 2 m; Děrovaná; Dle normy EN 60715; Šířka otvorů 25 mm; vzdálenost mezi otvory 36 mm

www.wago.com/210-112

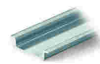

Obj. č.: 210-113

Ocelová nosná lišta; 35 × 7,5 mm; Tloušťka 1 mm; Délka 2 m; Neděrovaná; Dle normy EN 60715

www.wago.com/210-113



Obj. č.: 210-114

Ocelová nosná lišta; 35 × 15 mm; Tloušťka 1,5 mm; Délka 2 m; Neděrovaná; Podobné EN 60715

www.wago.com/210-114

Obj. č.: 210-115

Ocelová nosná lišta; 35 × 7,5 mm; Tloušťka 1 mm; Délka 2 m; Děrovaná; Dle normy EN 60715; Šířka otvorů 18 mm; vzdálenost mezi otvory 25 mm

www.wago.com/210-115

Obj. č.: 210-118

Ocelová nosná lišta; 35 × 15 mm; Tloušťka 2,3 mm; Délka 2 m; Neděrovaná; Dle normy EN 60715

www.wago.com/210-118

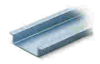

Obj. č.: 210-196

Hliníková nosná lišta; 35 × 8,2 mm; Tloušťka 1,6 mm; Délka 2 m; Neděrovaná; Podobné EN 60715; Stříbrná

www.wago.com/210-196



Obj. č.: 210-197

Ocelová nosná lišta; 35 × 15 mm; Tloušťka 1,5 mm; Délka 2 m; Děrovaná; Podobné EN 60715

www.wago.com/210-197



Obj. č.: 210-198

Měděná nosná lišta; 35 × 15 mm; Tloušťka 2,3 mm; Délka 2 m; Neděrovaná; Dle normy EN 60715; Měděná

www.wago.com/210-198



Obj. č.: 210-504

Ocelová nosná lišta; 35 × 7,5 mm; Tloušťka 1 mm; Délka 2 m; Děrovaná; Pásově zinkováno; Dle normy EN 60715

www.wago.com/210-504

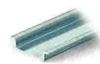

Obj. č.: 210-505

Ocelová nosná lišta; 35 × 7,5 mm; Tloušťka 1 mm; Délka 2 m; Neděrovaná; Pásově zinkováno; Dle normy EN 60715

www.wago.com/210-505



Obj. č.: 210-506

Ocelová nosná lišta; 35 × 15 mm; Tloušťka 1,5 mm; Délka 2 m; Neděrovaná; Pásově zinkováno; Podobné EN 60715

www.wago.com/210-506



Obj. č.: 210-508

Ocelová nosná lišta; 35 × 15 mm; Tloušťka 1,5 mm; Délka 2 m; Děrovaná; Pásově zinkováno; Podobné EN 60715

www.wago.com/210-508

tools



Obj. č.: 210-657

Ovládací nástroj; Břit: 3,5 × 0,5 mm; S částečně izolovanou rukojetí; Krátké

www.wago.com/210-657



Obj. č.: 210-658

Ovládací nástroj; Břit: 3,5 × 0,5 mm; S částečně izolovanou rukojetí; Úhlové provedení; Krátké

www.wago.com/210-658



Obj. č.: 210-720
Ovládací nástroj; Břit: 3,5 × 0,5 mm; S částečně izolovanou rukojetí

www.wago.com/210-720

General accessories



Obj. č.: 231-162/003-000
Male connector for rail-mount terminal blocks; 1.2 x 1.2 mm pins; Rovné provedení; Rozteč 5 mm; 2pól.; Šedá

www.wago.com/231-162/003-000



Obj. č.: 231-163/003-000
Male connector for rail-mount terminal blocks; 1.2 x 1.2 mm pins; Rovné provedení; Rozteč 5 mm; 3pól.; Šedá

www.wago.com/231-163/003-000



Obj. č.: 231-164/003-000
Male connector for rail-mount terminal blocks; 1.2 x 1.2 mm pins; Rovné provedení; Rozteč 5 mm; 4pól.; Šedá

www.wago.com/231-164/003-000



Obj. č.: 231-165/003-000
Male connector for rail-mount terminal blocks; 1.2 x 1.2 mm pins; Rovné provedení; Rozteč 5 mm; 5pól.; Šedá

www.wago.com/231-165/003-000



Obj. č.: 231-166/003-000
Male connector for rail-mount terminal blocks; 1.2 x 1.2 mm pins; Rovné provedení; Rozteč 5 mm; 6pól.; Šedá

www.wago.com/231-166/003-000



Obj. č.: 231-167/003-000
Male connector for rail-mount terminal blocks; 1.2 x 1.2 mm pins; Rovné provedení; Rozteč 5 mm; 7pól.; Šedá

www.wago.com/231-167/003-000



Obj. č.: 231-168/003-000
Male connector for rail-mount terminal blocks; 1.2 x 1.2 mm pins; Rovné provedení; Rozteč 5 mm; 8pól.; Šedá

www.wago.com/231-168/003-000



Obj. č.: 231-169/003-000
Male connector for rail-mount terminal blocks; 1.2 x 1.2 mm pins; Rovné provedení; Rozteč 5 mm; 9pól.; Šedá

www.wago.com/231-169/003-000



Obj. č.: 231-170/003-000
Male connector for rail-mount terminal blocks; 1.2 x 1.2 mm pins; Rovné provedení; Rozteč 5 mm; 10pól.; Šedá

www.wago.com/231-170/003-000



Obj. č.: 231-171/003-000
Male connector for rail-mount terminal blocks; 1.2 x 1.2 mm pins; Rovné provedení; Rozteč 5 mm; 11pól.; Šedá

www.wago.com/231-171/003-000



Obj. č.: 231-172/003-000
Male connector for rail-mount terminal blocks; 1.2 x 1.2 mm pins; Rovné provedení; Rozteč 5 mm; 12pól.; Šedá

www.wago.com/231-172/003-000



Obj. č.: 231-176/003-000
Male connector for rail-mount terminal blocks; 1.2 x 1.2 mm pins; Rovné provedení; Rozteč 5 mm; 16pól.; Šedá

www.wago.com/231-176/003-000

















Obj. č.: 231-180/003-000
Male connector for rail-mount terminal blocks; 1.2 x 1.2 mm pins; Rovné provedení; Rozteč 5 mm; 20pól.; Šedá







www.wago.com/231-180/003-000





Obj. č.: 231-668
Zavírací kolíky; K uzavření nepotřebných kontaktních míst; Šedá

www.wago.com/231-668

	Obj. č.: 231-669 Zavírací kolíky; K uzavření nepotřebných kontaktních míst; Oranžová	www.wago.com/231-669
	Obj. č.: 281-511 Pojistkový modul; Se sponkou; Pro pojistkové vložky G 5 × 20 mm a 5 × 25 mm; Bez indikace poruchy; www.wago.com/281-511 Šířka 6 mm; Šedá	
	Obj. č.: 281-512 Pojistkový modul; Se sponkou; Pro pojistkové vložky G 5 × 20 mm a 5 × 25 mm; S přípojkou pro LED diodu; Šířka 6 mm; Šedá	www.wago.com/281-512
	Obj. č.: 281-512/281-417 Pojistkový modul; Se sponkou; Pro pojistkové vložky G 5 × 20 mm a 5 × 25 mm; S indikací poruchy doutnavkou; 230 V; Šířka 6 mm; Šedá	www.wago.com/281-512/281-417
	Obj. č.: 281-512/281-418 Pojistkový modul; Se sponkou; Pro pojistkové vložky G 5 × 20 mm a 5 × 25 mm; S indikací poruchy doutnavkou; 120 V; Šířka 6 mm; Šedá	www.wago.com/281-512/281-418
	Obj. č.: 281-512/281-501 Pojistkový modul; Se sponkou; Pro pojistkové vložky G 5 × 20 mm a 5 × 25 mm; S LED indikátorem; AC/DC 24 V; Šířka 6 mm; Šedá	www.wago.com/281-512/281-501
	Obj. č.: 721-162/003-000 Male connector for rail-mount terminal blocks; 1.2 x 1.2 mm pins; Rovné provedení; 100% ochrana proti chybnému zapojení; Rozteč 5 mm; 2pól.; Světle šedá	www.wago.com/721-162/003-000
	Obj. č.: 721-163/003-000 Male connector for rail-mount terminal blocks; 1.2 x 1.2 mm pins; Rovné provedení; 100% ochrana proti chybnému zapojení; Rozteč 5 mm; 3pól.; Světle šedá	www.wago.com/721-163/003-000
	Obj. č.: 721-164/003-000 Male connector for rail-mount terminal blocks; 1.2 x 1.2 mm pins; straight; 100% protected against mismatching; Pin spacing 5 mm; 4-pole; light gray	www.wago.com/721-164/003-000
	Obj. č.: 721-165/003-000 Male connector for rail-mount terminal blocks; 1.2 x 1.2 mm pins; Rovné provedení; 100% ochrana proti chybnému zapojení; Rozteč 5 mm; 5pól.; Světle šedá	www.wago.com/721-165/003-000
	Obj. č.: 721-166/003-000 Male connector for rail-mount terminal blocks; 1.2 x 1.2 mm pins; Rovné provedení; 100% ochrana proti chybnému zapojení; Rozteč 5 mm; 6pól.; Světle šedá	www.wago.com/721-166/003-000
	Obj. č.: 721-167/003-000 Male connector for rail-mount terminal blocks; 1.2 x 1.2 mm pins; Rovné provedení; 100% ochrana proti chybnému zapojení; Rozteč 5 mm; 7pól.; Světle šedá	www.wago.com/721-167/003-000
	Obj. č.: 721-168/003-000 Male connector for rail-mount terminal blocks; 1.2 x 1.2 mm pins; Rovné provedení; 100% ochrana proti chybnému zapojení; Rozteč 5 mm; 8pól.; Světle šedá	www.wago.com/721-168/003-000
	Obj. č.: 721-169/003-000 Male connector for rail-mount terminal blocks; 1.2 x 1.2 mm pins; Rovné provedení; 100% ochrana proti chybnému zapojení; Rozteč 5 mm; 9pól.; Světle šedá	www.wago.com/721-169/003-000
	Obj. č.: 721-170/003-000 Male connector for rail-mount terminal blocks; 1.2 x 1.2 mm pins; Rovné provedení; 100% ochrana proti chybnému zapojení; Rozteč 5 mm; 10pól.; Světle šedá	www.wago.com/721-170/003-000



















	Obj. č.: 721-171/003-000 Male connector for rail-mount terminal blocks; 1.2 x 1.2 mm pins; straight; 100% protected against mismatching; Pin spacing 5 mm; 11-pole; light gray	www.wago.com/721-171/003-000
	Obj. č.: 721-172/003-000 Male connector for rail-mount terminal blocks; 1.2 x 1.2 mm pins; Rovné provedení; 100% ochrana proti chybnému zapojení; Rozteč 5 mm; 12pól.; Světle šedá	www.wago.com/721-172/003-000
	Obj. č.: 721-173/003-000 Male connector for rail-mount terminal blocks; 1.2 x 1.2 mm pins; straight; 100% protected against mismatching; Pin spacing 5 mm; 13-pole; light gray	www.wago.com/721-173/003-000
	Obj. č.: 721-174/003-000 Male connector for rail-mount terminal blocks; 1.2 x 1.2 mm pins; straight; 100% protected against mismatching; Pin spacing 5 mm; 14-pole; light gray	www.wago.com/721-174/003-000
	Obj. č.: 721-175/003-000 Male connector for rail-mount terminal blocks; 1.2 x 1.2 mm pins; straight; 100% protected against mismatching; Pin spacing 5 mm; 15-pole; light gray	www.wago.com/721-175/003-000
	Obj. č.: 721-176/003-000 Male connector for rail-mount terminal blocks; 1.2 x 1.2 mm pins; Rovné provedení; 100% ochrana proti chybnému zapojení; Rozteč 5 mm; 16pól.; Světle šedá	www.wago.com/721-176/003-000
	Obj. č.: 721-180/003-000 Male connector for rail-mount terminal blocks; 1.2 x 1.2 mm pins; straight; 100% protected against mismatching; Pin spacing 5 mm; 20-pole; light gray	www.wago.com/721-180/003-000

assembling

	Obj. č.: 209-106 Držák; K izolované montáži nosných lišt DIN 35; Šedá	www.wago.com/209-106
	Obj. č.: 709-154 Krycí profil; Typ 2; Vhodný pro držák krycího profilu typu 2; Délka 1 m; Transparentní	www.wago.com/709-154

Jumper

	Obj. č.: 210-103 Vícenásobný vodičový můstek; Izolováno; 50 přípojek; Černá	www.wago.com/210-103
	Obj. č.: 210-123 Vícenásobný vodičový můstek; Izolováno; 50 přípojek	www.wago.com/210-123
	Obj. č.: 249-123 Vodičový můstek; Izolováno; L = 180 mm; Průřez vedení 0,75 mm²	www.wago.com/249-123
	Obj. č.: 249-125 Vodičový můstek; Izolováno; L = 60 mm; Průřez vedení 0,75 mm²	www.wago.com/249-125
	Obj. č.: 249-126 Vodičový můstek; Izolováno; L = 110 mm; Průřez vedení 0,75 mm²	www.wago.com/249-126
	Obj. č.: 249-127 Vodičový můstek; Izolováno; L = 250 mm; Průřez vedení 0,75 mm²	www.wago.com/249-127
	Obj. č.: 280-402 Příčný můstek; Izolováno; IN = IN svorky; Šedá	www.wago.com/280-402
	Obj. č.: 280-409 Příčný můstek ob svorku; Izolováno; IN = IN svorky; Šedá	www.wago.com/280-409

	Obj. č.: 280-482 Hřebenový můstek; Izolováno; 2x; IN = IN svorky; Šedá	www.wago.com/280-482
	Obj. č.: 280-483 Hřebenový můstek; Izolováno; 3x; IN = IN svorky; Šedá	www.wago.com/280-483
	Obj. č.: 280-484 Hřebenový můstek; Izolováno; 4x; IN = IN svorky; Šedá	www.wago.com/280-484
	Obj. č.: 280-485 Hřebenový můstek; Izolováno; 5x; IN = IN svorky; Šedá	www.wago.com/280-485
	Obj. č.: 280-490 Hřebenový můstek; Izolováno; 10x; IN = IN svorky; Šedá	www.wago.com/280-490
	Obj. č.: 280-492 Hřebenový můstek ob svorku; Izolováno; 2x; IN = IN svorky; Šedá	www.wago.com/280-492
	Obj. č.: 709-110 Vícenásobný vodičový můstek; Izolováno; 4 přípojky; 3 × 110 mm; Černá	www.wago.com/709-110
	Obj. č.: 709-111 Vícenásobný vodičový můstek; Izolováno; 3 přípojek; 2 × 120 mm; Černá	www.wago.com/709-111
	Obj. č.: 709-112 Vícenásobný vodičový můstek; Izolováno; 3 přípojek; 2 × 170 mm; Černá	www.wago.com/709-112
	Obj. č.: 780-452 Stupňovitý můstek; Izolováno; Z 1 na 2; Rozteč 5 mm; Vhodný pro 2vodičové pružinové svorkovnice; Šedá	www.wago.com/780-452
	Obj. č.: 780-453 Stupňovitý můstek; Izolováno; z 1 na 3; Rozteč 5 mm; Vhodný pro 2vodičové pružinové svorkovnice; Šedá	www.wago.com/780-453
	Obj. č.: 780-454 Stupňovitý můstek; Izolováno; Z 1 na 4; Rozteč 5 mm; Vhodný pro 2vodičové pružinové svorkovnice; Šedá	www.wago.com/780-454
	Obj. č.: 780-455 Stupňovitý můstek; Izolováno; Z 1 na 5; Rozteč 5 mm; Vhodný pro 2vodičové pružinové svorkovnice; Šedá	www.wago.com/780-455
	Obj. č.: 780-456 Stupňovitý můstek; Izolováno; Z 1 na 6; Rozteč 5 mm; Vhodný pro 2vodičové pružinové svorkovnice; Šedá	www.wago.com/780-456
	Obj. č.: 780-457 Stupňovitý můstek; Izolováno; Z 1 na 7; Rozteč 5 mm; Vhodný pro 2vodičové pružinové svorkovnice; Šedá	www.wago.com/780-457
	Obj. č.: 780-458 Stupňovitý můstek; Izolováno; Z 1 na 8; Rozteč 5 mm; Vhodný pro 2vodičové pružinové svorkovnice; Šedá	www.wago.com/780-458
Insulation stop		
	Obj. č.: 280-470 Izolační zarážka; 0,08–0,2 mm ² „e“ (0,14 mm ² „f“); 5 ks/pás; Bílá	www.wago.com/280-470
	Obj. č.: 280-471 Izolační zarážka; 0,25–0,5 mm ² ; 5 ks/pás; Světle šedá	www.wago.com/280-471



Obj. č.: 280-472
Izolační zarážka; 0,75–1 mm²; 5 ks/pás

www.wago.com/280-472

End plate



Obj. č.: 280-342
Koncová bočnice a separátor; Tloušťka 2,5 mm; Šedá

www.wago.com/280-342



Obj. č.: 280-343
Koncová bočnice a separátor; Tloušťka 2,5 mm; Oranžová

www.wago.com/280-343



Obj. č.: 280-369
Oddělující deska; Tloušťka 1,1 mm; Oranžová

www.wago.com/280-369

ferrule



Obj. č.: 216-101
Dutinka; Objímka na 0,5 mm² / AWG 22; Bez plastového límce; Galvanicky pocínováno

www.wago.com/216-101



Obj. č.: 216-102
Dutinka; Objímka na 0,75 mm² / AWG 20; Bez plastového límce; Galvanicky pocínováno

www.wago.com/216-102



Obj. č.: 216-103
Dutinka; Objímka na 1 mm² / AWG 18; Bez plastového límce; Galvanicky pocínováno

www.wago.com/216-103



Obj. č.: 216-104
Dutinka; Objímka na 1,5 mm² / AWG 16; Bez plastového límce; Galvanicky pocínováno

www.wago.com/216-104



Obj. č.: 216-201
Ferrule; Sleeve for 0.5 mm² / 20 AWG; insulated; electro-tin plated; white

www.wago.com/216-201



Obj. č.: 216-202
Ferrule; Sleeve for 0.75 mm² / 18 AWG; insulated; electro-tin plated; gray

www.wago.com/216-202



Obj. č.: 216-203
Dutinka; Objímka na 1 mm² / AWG 18; S plastovým límcem; Galvanicky pocínováno; Červená

www.wago.com/216-203



Obj. č.: 216-204
Dutinka; Objímka na 1,5 mm² / AWG 16; S plastovým límcem; Galvanicky pocínováno; Černá

www.wago.com/216-204

Obj. č.: 216-301
Dutinka; Objímka na 0,25 mm² / AWG 24; S plastovým límcem; Galvanicky pocínováno; Žlutá

www.wago.com/216-301



Obj. č.: 216-302
Ferrule; Sleeve for 0.34 mm² / 22 AWG; insulated; electro-tin plated; green

www.wago.com/216-302

Marking accessories



Obj. č.: 2009-115
WMB Inline; Pro Smart Printer; Na cívce; Flexibilní, 5–5,2 mm; Bez potisku; Možnost naklapnutí; Bílá

www.wago.com/2009-115



Obj. č.: 2009-115/000-002
WMB Inline; Pro Smart Printer; Na cívce; Flexibilní, 5–5,2 mm; Bez potisku; Možnost naklapnutí; Žlutá

www.wago.com/2009-115/000-002

















Obj. č.: 2009-115/000-006
WMB Inline; Pro Smart Printer; Na cívce; Flexibilní, 5–5,2 mm; Bez potisku; Možnost naklapnutí; Modrá

www.wago.com/2009-115/000-006



Obj. č.: 2009-115/000-007
WMB Inline; Pro Smart Printer; Na cívce; Flexibilní, 5–5,2 mm; Bez potisku; Možnost naklapnutí; Šedá

www.wago.com/2009-115/000-007

	Obj. č.: 2009-115/000-012 WMB Inline; Pro Smart Printer; Na cívce; Flexibilní, 5–5,2 mm; Bez potisku; Možnost naklapnutí; Oranžová	www.wago.com/2009-115/000-012
	Obj. č.: 2009-115/000-017 WMB Inline; Pro Smart Printer; Na cívce; Flexibilní, 5–5,2 mm; Bez potisku; Možnost naklapnutí; Světle zelená	www.wago.com/2009-115/000-017
	Obj. č.: 2009-115/000-023 WMB Inline; Pro Smart Printer; Na cívce; Flexibilní, 5–5,2 mm; Bez potisku; Možnost naklapnutí; Zelená	www.wago.com/2009-115/000-023
	Obj. č.: 2009-115/000-024 WMB Inline; Pro Smart Printer; Na cívce; Flexibilní, 5–5,2 mm; Bez potisku; Možnost naklapnutí; Fialová	www.wago.com/2009-115/000-024
	Obj. č.: 793-501 Popisovací karta WMB; Jako karta; Neflexibilní; Bez potisku; Možnost naklapnutí; Bílá	www.wago.com/793-501
	Obj. č.: 793-501/000-002 Popisovací karta WMB; Jako karta; Neflexibilní; Bez potisku; Možnost naklapnutí; Bílá	www.wago.com/793-501/000-002
	Obj. č.: 793-501/000-005 Popisovací karta WMB; Jako karta; Neflexibilní; Bez potisku; Možnost naklapnutí; Červená	www.wago.com/793-501/000-005
	Obj. č.: 793-501/000-006 Popisovací karta WMB; Jako karta; Neflexibilní; Bez potisku; Možnost naklapnutí; Modrá	www.wago.com/793-501/000-006
	Obj. č.: 793-501/000-007 Popisovací karta WMB; Jako karta; Neflexibilní; Bez potisku; Možnost naklapnutí; Šedá	www.wago.com/793-501/000-007
	Obj. č.: 793-501/000-012 Popisovací karta WMB; Jako karta; Neflexibilní; Bez potisku; Možnost naklapnutí; Oranžová	www.wago.com/793-501/000-012
	Obj. č.: 793-501/000-017 Popisovací karta WMB; Jako karta; Neflexibilní; Bez potisku; Možnost naklapnutí; Světle zelená	www.wago.com/793-501/000-017
	Obj. č.: 793-501/000-023 Popisovací karta WMB; Jako karta; Neflexibilní; Bez potisku; Možnost naklapnutí; Zelená	www.wago.com/793-501/000-023
	Obj. č.: 793-501/000-024 Popisovací karta WMB; Jako karta; Neflexibilní; Bez potisku; Možnost naklapnutí; Fialová	www.wago.com/793-501/000-024
	Obj. č.: 793-5501 Popisovací karta WMB; Jako karta; Pro svorky o šířce 5–17,5 mm; Flexibilní, 5–5,2 mm; Bez potisku; Možnost naklapnutí; Bílá	www.wago.com/793-5501
	Obj. č.: 793-5501/000-002 Popisovací karta WMB; Jako karta; Pro svorky o šířce 5–17,5 mm; Flexibilní, 5–5,2 mm; Bez potisku; Možnost naklapnutí; Žlutá	www.wago.com/793-5501/000-002



Obj. č.: 793-5501/000-005

Popisovací karta WMB; Jako karta; Flexibilní, 5–5,2 mm; Bez potisku; Možnost naklapnutí; Červená

www.wago.com/793-5501/000-005



Obj. č.: 793-5501/000-006

Popisovací karta WMB; Jako karta; Flexibilní, 5–5,2 mm; Bez potisku; Možnost naklapnutí; Modrá

www.wago.com/793-5501/000-006



Obj. č.: 793-5501/000-007

Popisovací karta WMB; Jako karta; Flexibilní, 5–5,2 mm; Bez potisku; Možnost naklapnutí; Šedá

www.wago.com/793-5501/000-007



Obj. č.: 793-5501/000-012

Popisovací karta WMB; Jako karta; Flexibilní, 5–5,2 mm; Bez potisku; Možnost naklapnutí; Oranžová

www.wago.com/793-5501/000-012



Obj. č.: 793-5501/000-017

Popisovací karta WMB; Jako karta; Flexibilní, 5–5,2 mm; Bez potisku; Možnost naklapnutí; Světle zelená

www.wago.com/793-5501/000-017



Obj. č.: 793-5501/000-023

Popisovací karta WMB; Jako karta; Flexibilní, 5–5,2 mm; Bez potisku; Možnost naklapnutí; Zelená

www.wago.com/793-5501/000-023



Obj. č.: 793-5501/000-024

Popisovací karta WMB; Jako karta; Flexibilní, 5–5,2 mm; Bez potisku; Možnost naklapnutí; Fialová

www.wago.com/793-5501/000-024

Ke stažení

Documentation

Additional Information

Technical explanations	03-Apr-2019	pdf 2,1 MB	Stáhnout
------------------------	-------------	---------------	----------

CAD/CAE-Data

CAD data

2D/3D Models 280-532	URL	Stáhnout
----------------------	-----	----------

CAE data

EPLAN Data Portal 280-532	Stáhnout
---------------------------	----------

WSCAD Universe 280-532	Stáhnout
------------------------	----------

Handling Instructions

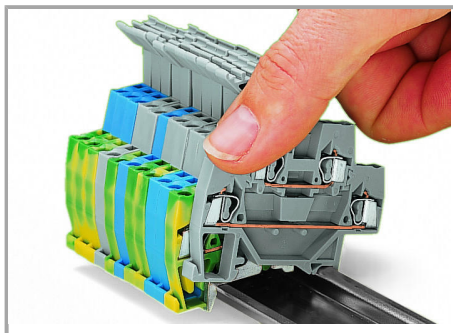

Snapping a terminal block onto the carrier rail.

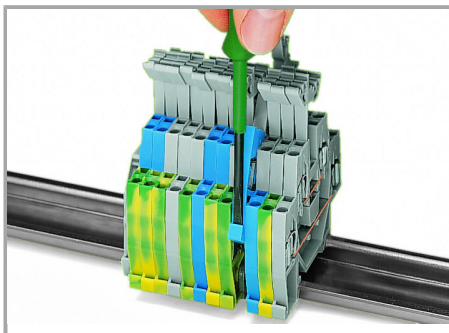

Removing a terminal block from the assembly.

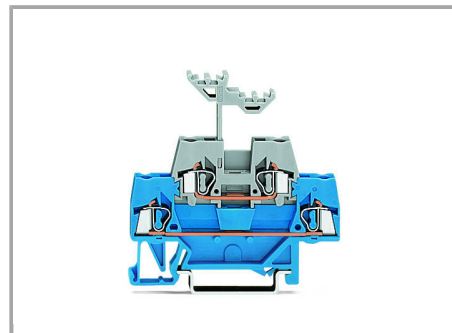

Double-deck terminal blocks accommodate two circuits of different potentials on two decks; different circuits can be differentiated by color coding either deck (280 Series). The lower deck is wider than the upper for ease of wiring.



The flexible marker carrier, which is placed above the wiring level, can be pushed aside during wiring or commoning. The carrier has two staggered levels for WMB markers that perfectly align with the terminal block decks.

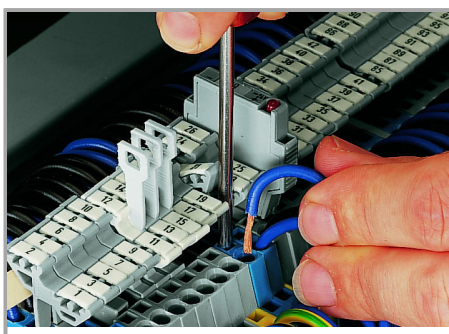

Změny vyhrazeny.

WAGO Elektro spol. sr. o.
Rozvodova 1116/36
143 00 Praha 12 - Modřany
Tel.: +420 261 090 143
Email: info.cz@wago.com, wago-cz@wago.com

Máte otázky ohledně našich produktů?
Kdykoli nám zavolejte na číslo +420 261 090 143.

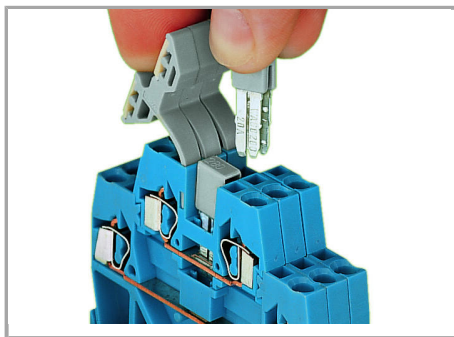

Commoning using an adjacent jumper (280-402).

Push jumper down until fully inserted.

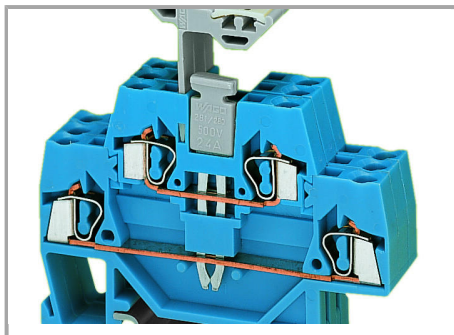

Commoning with a vertical jumper (281-421).



Combining vertical and adjacent jumpers.

Push vertical jumper down until fully inserted.

Změny vyhrazeny.

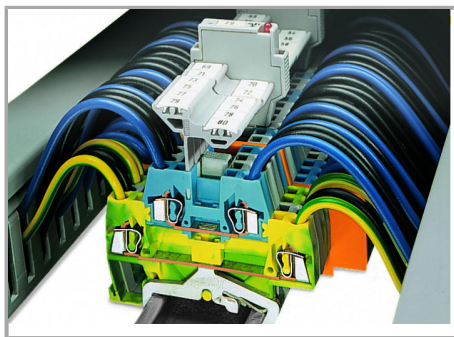

Example of a mixed assembly with double-deck terminal blocks.

The 280 Series Double-Deck Terminal Blocks are available with decks of same or different color according to their function. This is an additional visual aid during wiring, service or maintenance.

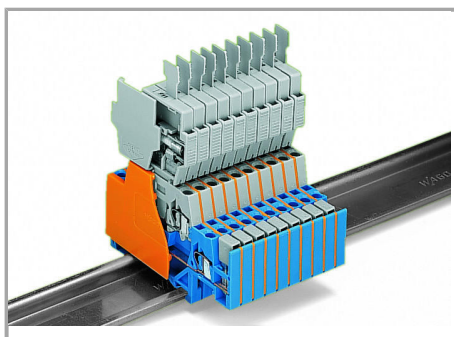

When double-deck terminal blocks are used with a fuse plug (6 mm wide) in the receptacle (top) level, the extra width can be compensated for the 280 Series (5 mm wide) via an intermediate plate (1.1 mm thick). If required, this special intermediate plate still allows commoning on the lower level via push-in adjacent jumpers (280-402).

Změny vyhrazeny.

WAGO Elektro spol. sr. o.
Rozvodova 1116/36
143 00 Praha 12 - Modřany
Tel.: +420 261 090 143
Email: info.cz@wago.com, wago-cz@wago.com

Máte otázky ohledně našich produktů?
Kdykoli nám zavolejte na číslo +420 261 090 143.

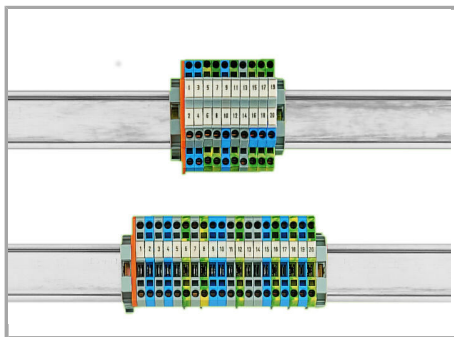

Save 50 % of rail space via double-deck terminal blocks.

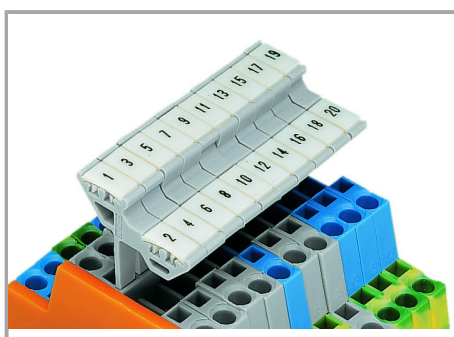

Labeling via WMB Multi Marking System.

Změny vyhrazeny.

WAGO Elektro spol. sr. o.
Rozvodova 1116/36
143 00 Praha 12 - Modřany
Tel.: +420 261 090 143
Email: info.cz@wago.com, wago-cz@wago.com

Máte otázky ohledně našich produktů?
Kdykoli nám zavolejte na číslo +420 261 090 143.