



### Hlavní parametry

Řada výrobků	Harmony XB5
Typ produktu nebo součásti	Hlava pro přepínač ovládaný klíčem
Označení přístroje	ZB5
Materiál obruby	Plast
Průměr pro montáž	22 mm
Typ hlavy	Standard
Prodej v nedělitelném množství	1
Tvar hlavice	Kruh
Typ ovládací hlavice	Pevná poloha
Provedení ovládače	Černá spínač s klíčem
Informace o polohách ovládače	3 pozice +/- 45°
Typ zámku	Dom 8D1
Pozice vyjmutí klíče	Vlevo a ve středu

### Doplňěk

CAD celková šířka	29 mm
CAD celková výška	29 mm
CAD celková hloubka	72 mm
Hmotnost přístroje	0,057 kg
Mechanická životnost	1000000 cykly
Označení skříně	XALD 1...5 výřezů XALK 2...5 výřezů
Označení el. složení	C11 pro 3 kontakty použitím jednoduchý bloky v čelní montáž SF1 pro 3 kontakty použitím jednoduchý bloky v čelní montáž C7 pro 4 kontakty použitím jednoduchý bloky v čelní montáž C8 pro 4 kontakty použitím jednoduchý a dvojitý bloky v čelní montáž SR1 pro 3 kontakty použitím jednoduchý bloky v montáž na desku ve dně skříně C4 pro 6 kontakty použitím jednoduchý a dvojitý bloky v čelní montáž C5 pro 5 kontakty použitím jednoduchý bloky v čelní montáž C6 pro 5 kontakty použitím jednoduchý a dvojitý bloky v čelní montáž C3 pro 6 kontakty použitím jednoduchý bloky v čelní montáž
Customizable	No

### Životní prostředí

stupeň ochrany	TH
teplota okolí pro uskladnění	-40...70 °C
teplota okolního vzduchu pro provoz	-40...70 °C
kategorie přepětí	Třída II podle IEC 60536
stupeň krytí IP	IP67 IP66 podle IEC 60529 IP69K IP69
stupeň krytí NEMA	NEMA 13 NEMA 4X
odolnost proti vysokému tlaku mytí	7000000 Pa při 55 °C, vzdálenost: 0,1 m
stupeň ochrany IK	IK06 podle IEC 50102
standards	EN/IEC 60947-1 EN/IEC 60947-5-1 EN/IEC 60947-5-4 JIS C 4520 UL 508 CSA C22.2 č. 14

certifikace výrobku

BV  
 CSA  
 DNV  
 GL  
 LROS (Lloyds register of shipping)  
 RINA  
 UL listed

odolnost proti vibracím	5 gn (f = 2...500 Hz) podle IEC 60068-2-6
odolnost proti otřesům	30 gn (doba trvání = 18 ms) pro akcelerace polovina sin. vlny podle IEC 60068-2-27 50 gn (doba trvání = 11 ms) pro akcelerace polovina sin. vlny podle IEC 60068-2-27

### Contractual warranty

Záruční lhůta	18 měsíců
---------------	-----------

### Dimensions

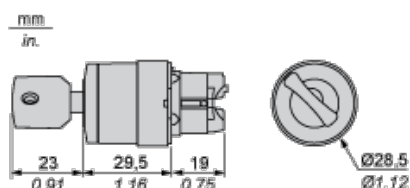

### Panel Cut-out for Pushbuttons, Switches and Pilot Lights (Finished Holes, Ready for Installation)

#### Connection by Screw Clamp Terminals or Plug-in Connectors or on Printed Circuit Board

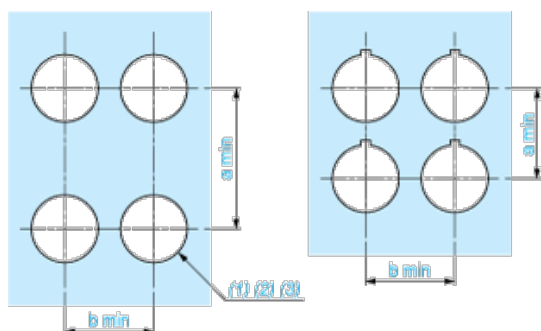

- (1) Diameter on finished panel or support
- (2) For selector switches and Emergency stop buttons, use of an anti-rotation plate type ZB5AZ902 is recommended.
- (3) Ø22.5 mm recommended (Ø22.3<sub>0</sub><sup>+0.4</sup>) / Ø0.89 in. recommended (Ø0.88 in. <sub>0</sub><sup>+0.016</sup>)

Connections	a in mm	a in in.	b in mm	b in in.
By screw clamp terminals or plug-in connector	40	1.57	30	1.18
By Faston connectors	45	1.77	32	1.26
On printed circuit board	30	1.18	30	1.18

#### Detail of Lug Recess

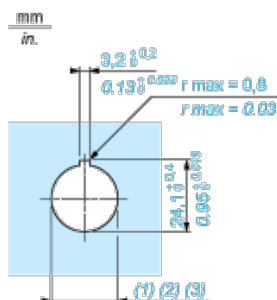

- (1) Diameter on finished panel or support
- (2) For selector switches and Emergency stop buttons, use of an anti-rotation plate type ZB5AZ902 is recommended.
- (3) Ø22.5 mm recommended (Ø22.3<sub>0</sub><sup>+0.4</sup>) / Ø0.89 in. recommended (Ø0.88 in. <sub>0</sub><sup>+0.016</sup>)

## Pushbuttons, Switches and Pilot Lights for Printed Circuit Board Connection

### Panel Cut-outs (Viewed from Installer's Side)

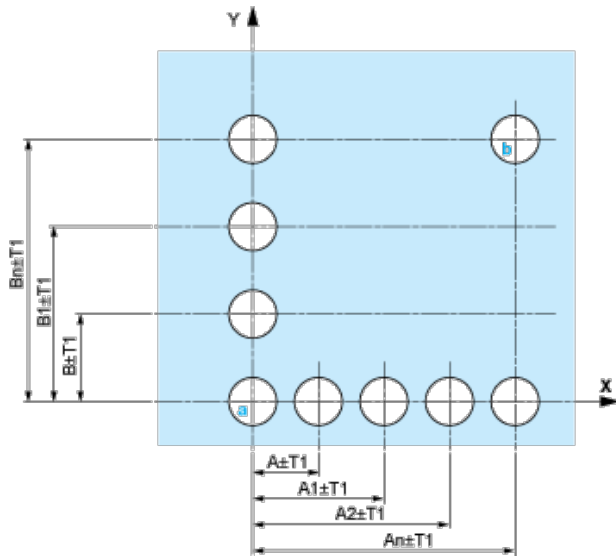

A: 30 mm min. / 1.18 in. min.

B: 40 mm min. / 1.57 in. min.

### Printed Circuit Board Cut-outs (Viewed from Electrical Block Side)

Dimensions in mm

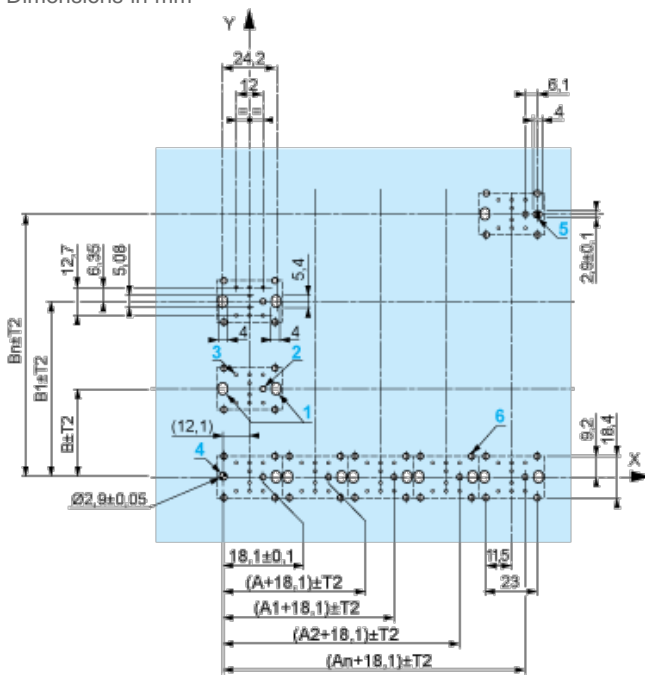

A: 30 mm min.

B: 40 mm min.

Dimensions in in.



A: 1.18 in. min.

B: 1.57 in. min.

### General Tolerances of the Panel and Printed Circuit Board

The cumulative tolerance must not exceed 0.3 mm / 0.012 in.:  $T_1 + T_2 = 0.3 \text{ mm max.}$

### Installation Precautions

- | Minimum thickness of circuit board: 1.6 mm / 0.06 in.
- | Cut-out diameter: 22.4 mm  $\pm$  0.1 / 0.88 in.  $\pm$  0.004
- | Orientation of body/fixing collar ZB5AZ009:  $\pm$  2°30' (excluding cut-outs marked **a** and **b**).
- | Tightening torque of screws ZBZ006: 0.6 N.m (5.3 lbf.in) max.
- | Allow for one ZB5AZ079 fixing collar/pillar and its fixing screws:
  - | every 90 mm / 3.54 in. horizontally (X), and 120 mm / 4.72 in. vertically (Y).
  - | with each selector switch head (ZB5AD•, ZB5AJ•, ZB5AG•).

The fixing centers marked **a** and **b** are diagonally opposed and must align with those marked 4 and 5.



- (1) Head ZB5AD•
- (2) Panel
- (3) Nut
- (4) Printed circuit board

### Mounting of Adapter (Socket) ZBZ01•

- | 1 2 elongated holes for ZBZ006 screw access
- | 2 1 hole  $\varnothing$  2.4 mm  $\pm$  0.05 / 0.09 in.  $\pm$  0.002 for centring adapter ZBZ01•
- | 3 8  $\times$   $\varnothing$  1.2 mm / 0.05 in. holes
- | 4 1 hole  $\varnothing$  2.9 mm  $\pm$  0.05 / 0.11 in.  $\pm$  0.002, for aligning the printed circuit board (with cut-out marked **a**)

- | 5 1 elongated hole for aligning the printed circuit board (with cut-out marked **b**)
- | 6 4 holes  $\varnothing$  2.4 mm / 0.09 in. for clipping in adapter ZBZ01•

Dimensions An + 18.1 relate to the  $\varnothing$  2.4 mm  $\pm$  0.05 / 0.09 in.  $\pm$  0.002 holes for centring adapter ZBZ01•.

### Electrical Composition Corresponding to Code C4

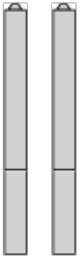

### Electrical Composition Corresponding to Code C5

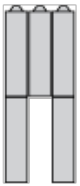

### Electrical Composition Corresponding to Code C6

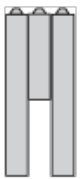

### Electrical Composition Corresponding to Code C7

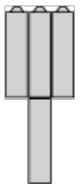

### Electrical Composition Corresponding to Code C8

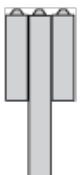

### Electrical Composition Corresponding to Code C3



### Electrical Composition Corresponding to Codes C9, C11, SF1 and SR1



### Legend

Single contact



Double contact



Light block



Possible location



### Sequence of Contacts Fitted to 3-position Selector Switch Body





#### Position 315°



<b>Push</b>	Position	Top			
		Bottom			
	Location		Left	Centre	Right
	State		1	1	0
<b>Contacts</b>	N/O	closed	closed	open	
	N/C	open	open	closed	



#### Position 0°



<b>Push</b>	Position	Top			
		Bottom			
	Location		Left	Centre	Right
	State		0	0	0
<b>Contacts</b>	N/O		open	open	open
	N/C		closed	closed	closed

**Position 45°**



<b>Push</b>	Position	Top			
		Bottom			
	Location		Left	Centre	Right
	State		0	1	1
<b>Contacts</b>	N/O		open	closed	closed
	N/C		closed	open	open