



Hlavní parametry

| | |
|--------------------------------|------------------------------------|
| Řada výrobků | Harmony XB5 |
| Typ produktu nebo součásti | Hlava pro přepínač |
| Označení přístroje | ZB5 |
| Materiál obruby | Dark grey plastic |
| Průměr pro montáž | 22 mm |
| Typ hlavy | Standard |
| Prodej v nedělitelném množství | 1 |
| Tvar hlavice | Kruh |
| Typ ovládací hlavice | S návratem z pravé strany na střed |
| Provedení ovládače | Černá standardní rukojeť |
| Informace o polohách ovládače | 3 pozice +/- 45° |

Doplňěk

| | |
|----------------------|--|
| CAD celková šířka | 29 mm |
| CAD celková výška | 29 mm |
| CAD celková hloubka | 46 mm |
| Hmotnost přístroje | 0,017 kg |
| Mechanická životnost | 1000000 cykly |
| Označení skříně | XALD 1...5 výřezů XALK 2...5 výřezů |
| Označení el. složení | C11 pro 3 kontakty použitím jednoduchý bloky v čelní montáž SF1 pro 3 kontakty použitím jednoduchý bloky v čelní montáž C7 pro 4 kontakty použitím jednoduchý bloky v čelní montáž C8 pro 4 kontakty použitím jednoduchý a dvojitý bloky v čelní montáž SR1 pro 3 kontakty použitím jednoduchý bloky v montáž na desku ve dně skříně C4 pro 6 kontakty použitím jednoduchý a dvojitý bloky v čelní montáž C5 pro 5 kontakty použitím jednoduchý bloky v čelní montáž C6 pro 5 kontakty použitím jednoduchý a dvojitý bloky v čelní montáž C3 pro 6 kontakty použitím jednoduchý bloky v čelní montáž |

Životní prostředí

| | |
|-------------------------------------|---|
| stupeň ochrany | TH |
| teplota okolí pro uskladnění | -40...70 °C |
| teplota okolního vzduchu pro provoz | -40...70 °C |
| kategorie přepětí | Třída II podle IEC 60536 |
| stupeň krytí IP | IP67 podle IEC 60529 IP69K IP69 podle IEC 60529 |
| stupeň krytí NEMA | NEMA 13 NEMA 4X |
| odolnost proti vysokému tlaku mytí | 7000000 Pa při 55 °C, vzdálenost: 0,1 m |
| stupeň ochrany IK | IK06 podle IEC 50102 |
| standards | EN/IEC 60947-1 EN/IEC 60947-5-1 EN/IEC 60947-5-4 JIS C 4520 UL 508 CSA C22.2 č. 14 |
| certifikace výrobku | BV CSA DNV GL LROS (Lloyds register of shipping) RINA UL listed |

| | |
|-------------------------|--|
| odolnost proti vibracím | 5 gn (f = 2...500 Hz) podle IEC 60068-2-6 |
| odolnost proti otřesům | 30 gn (doba trvání = 18 ms) pro akcelerace polovina sin. vlny podle IEC 60068-2-27 50 gn (doba trvání = 11 ms) pro akcelerace polovina sin. vlny podle IEC 60068-2-27 |

Contractual warranty

| | |
|---------------|-----------|
| Záruční lhůta | 18 měsíců |
|---------------|-----------|

Dimensions

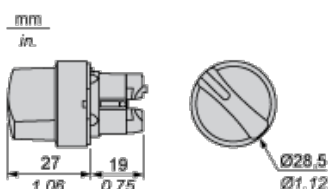

Panel Cut-out for Pushbuttons, Switches and Pilot Lights (Finished Holes, Ready for Installation)

Connection by Screw Clamp Terminals or Plug-in Connectors or on Printed Circuit Board

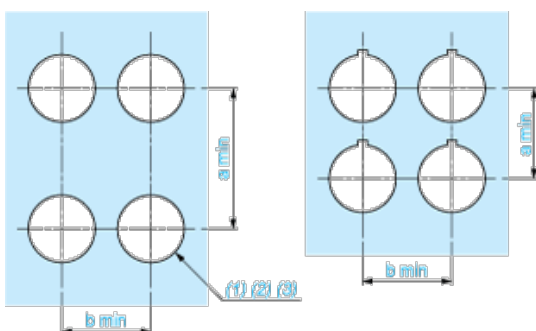

- (1) Diameter on finished panel or support
- (2) For selector switches and Emergency stop buttons, use of an anti-rotation plate type ZB5AZ902 is recommended.
- (3) $\varnothing 22.5$ mm recommended ($\varnothing 22.3 \text{ }_0^{+0.4}$) / $\varnothing 0.89$ in. recommended ($\varnothing 0.88 \text{ in. }_0^{+0.016}$)

| Connections | a in mm | a in in. | b in mm | b in in. |
|---|---------|----------|---------|----------|
| By screw clamp terminals or plug-in connector | 40 | 1.57 | 30 | 1.18 |
| By Faston connectors | 45 | 1.77 | 32 | 1.26 |
| On printed circuit board | 30 | 1.18 | 30 | 1.18 |

Detail of Lug Recess

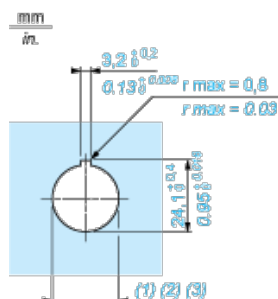

- (1) Diameter on finished panel or support
- (2) For selector switches and Emergency stop buttons, use of an anti-rotation plate type ZB5AZ902 is recommended.
- (3) $\varnothing 22.5$ mm recommended ($\varnothing 22.3 \text{ }_0^{+0.4}$) / $\varnothing 0.89$ in. recommended ($\varnothing 0.88 \text{ in. }_0^{+0.016}$)

Pushbuttons, Switches and Pilot Lights for Printed Circuit Board Connection

Panel Cut-outs (Viewed from Installer's Side)

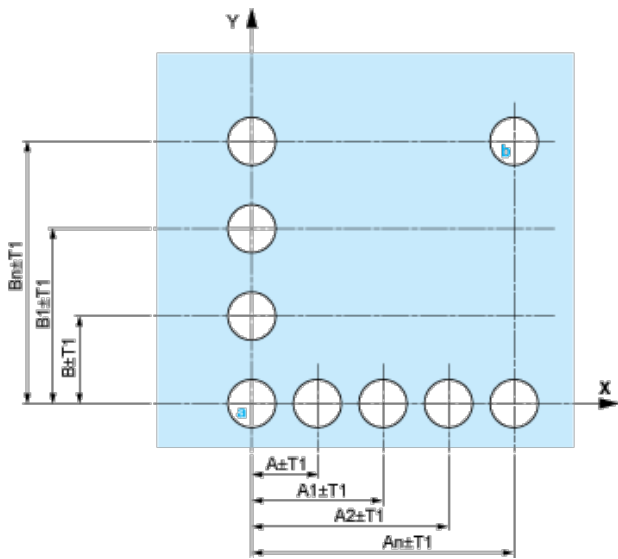

A: 30 mm min. / 1.18 in. min.

B: 40 mm min. / 1.57 in. min.

Printed Circuit Board Cut-outs (Viewed from Electrical Block Side)

Dimensions in mm

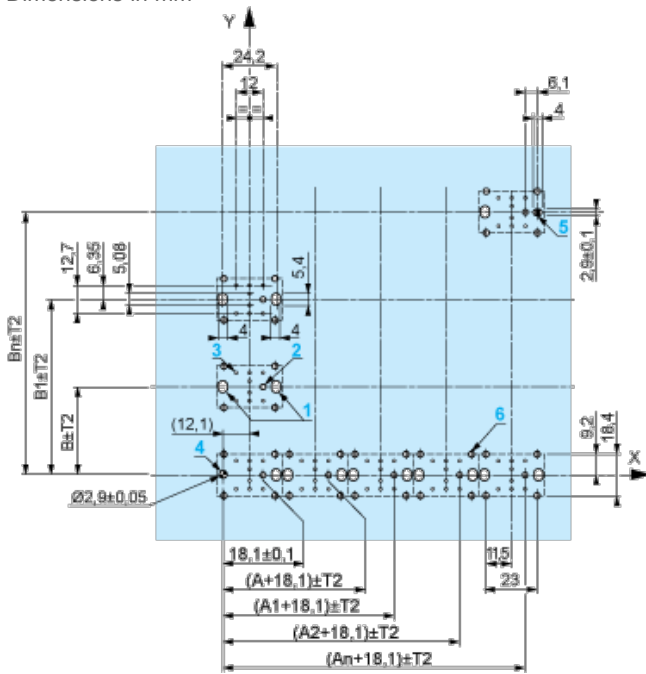

A: 30 mm min.

B: 40 mm min.

Dimensions in in.



A: 1.18 in. min.

B: 1.57 in. min.

General Tolerances of the Panel and Printed Circuit Board

The cumulative tolerance must not exceed 0.3 mm / 0.012 in.: $T_1 + T_2 = 0.3 \text{ mm max.}$

Installation Precautions

- | Minimum thickness of circuit board: 1.6 mm / 0.06 in.
- | Cut-out diameter: 22.4 mm \pm 0.1 / 0.88 in. \pm 0.004
- | Orientation of body/fixing collar ZB5AZ009: \pm 2°30' (excluding cut-outs marked **a** and **b**).
- | Tightening torque of screws ZBZ006: 0.6 N.m (5.3 lbf.in) max.
- | Allow for one ZB5AZ079 fixing collar/pillar and its fixing screws:
 - | every 90 mm / 3.54 in. horizontally (X), and 120 mm / 4.72 in. vertically (Y).
 - | with each selector switch head (ZB5AD•, ZB5AJ•, ZB5AG•).

The fixing centers marked **a** and **b** are diagonally opposed and must align with those marked 4 and 5.



- (1) Head ZB5AD•
- (2) Panel
- (2) Nut
- (4) Printed circuit board

Mounting of Adapter (Socket) ZBZ01•

- | 1 2 elongated holes for ZBZ006 screw access
- | 2 1 hole \varnothing 2.4 mm \pm 0.05 / 0.09 in. \pm 0.002 for centring adapter ZBZ01•
- | 3 8 \times \varnothing 1.2 mm / 0.05 in. holes
- | 4 1 hole \varnothing 2.9 mm \pm 0.05 / 0.11 in. \pm 0.002, for aligning the printed circuit board (with cut-out marked **a**)

- | 5 1 elongated hole for aligning the printed circuit board (with cut-out marked **b**)
- | 6 4 holes \varnothing 2.4 mm / 0.09 in. for clipping in adapter ZBZ01•

Dimensions An + 18.1 relate to the \varnothing 2.4 mm \pm 0.05 / 0.09 in. \pm 0.002 holes for centring adapter ZBZ01•.

Electrical Composition Corresponding to Code C3



Electrical Composition Corresponding to Code C4



Electrical Composition Corresponding to Code C5

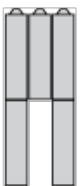

Electrical Composition Corresponding to Code C6



Electrical Composition Corresponding to Code C7



Electrical Composition Corresponding to Code C8



Electrical Composition Corresponding to Codes C9, C11, SF1 and SR1



Electrical Composition Corresponding to Code C15

1 N/O



1 N/C



1 N/O + N/C or 1 N/O + N/O or 1 N/C + N/C



Legend

Single contact



Double contact



Light block



Possible location



Sequence of Contacts Fitted to 3-position Selector Switch Body





Position 315°



| | | | | | |
|-----------------|----------|--------|---|---|--------|
| Push | Position | Top |  | | |
| | | Bottom |  |  | |
| | Location | | Left | Centre | Right |
| | State | | 1 | 1 | 0 |
| Contacts | N/O | | closed | closed | open |
| | N/C | | open | open | closed |



Position 0°



| | | | | | |
|-----------------|----------|--------|---|---|---|
| Push | Position | Top |  | | |
| | | Bottom |  |  |  |
| | Location | | Left | Centre | Right |
| | State | | 0 | 0 | 0 |
| Contacts | N/O | | open | open | open |
| | N/C | | closed | closed | closed |

Position 45°



| | | | | | |
|-----------------|----------|--------|---|---|--------|
| Push | Position | Top |  | | |
| | | Bottom |  |  | |
| | Location | | Left | Centre | Right |
| | State | | 0 | 1 | 1 |
| Contacts | N/O | | open | closed | closed |
| | N/C | | closed | open | open |