

ZB4BL432

červená ovl. hlavice stiskací s přesah. Ø22 s návratem "O"

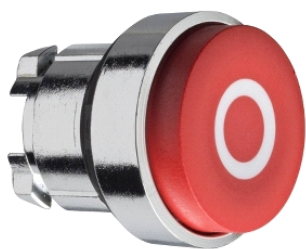

Hlavní parametry

Řada výrobků	Harmony XB4
Typ produktu nebo součásti	Hlava pro neprosvětlené tlačítko
Označení přístroje	ZB4
Materiál obruby	Kovová chromovaná
Průměr pro montáž	22 mm
Prodej v nedělitelném množství	1
Typ hlavy	Standard
Tvar hlavice	Kruh
Typ ovládací hlavice	S návratem
Provedení ovládače	Červená s přesahem, bílá O

Doplňěk

CAD celková šířka	29 mm
CAD celková výška	29 mm
CAD celková hloubka	33 mm
Mechanická životnost	10000000 cykly
Označení el. složení	C15 pro 1 kontakty použitím jednoduchých bloky v čelní montáž C15 pro 1 kontakty použitím jednoduchých bloky v čelní montáž C11 pro 3 kontakty použitím jednoduchých bloky v čelní montáž C1 for 9 contacts using single blocks in front mounting C2 for 9 contacts using single and double blocks in front mounting

Životní prostředí

stupeň ochrany	TH
teplota okolí pro uskladnění	-40...70 °C
teplota okolního vzduchu pro provoz	-40...70 °C
kategorie přepětí	Třída I podle IEC 60536
stupeň krytí IP	IP67 IP66 podle IEC 60529 IP69K IP69
stupeň krytí NEMA	NEMA 13 NEMA 4X
stupeň ochrany IK	IK06 podle IEC 50102
standards	EN/IEC 60947-1 EN/IEC 60947-5-1 EN/IEC 60947-5-4 EN/IEC 60947-5-5 JIS C 4520 UL 508 CSA C22.2 č. 14
certifikace výrobku	BV CSA DNV GL LROS (Lloyds register of shipping) RINA UL listed
odolnost proti vibracím	5 gn (f = 2...500 Hz) podle IEC 60068-2-6
odolnost proti otřesům	30 gn (doba trvání = 18 ms) pro akcelerace polovina sin. vlny podle IEC 60068-2-27 50 gn (doba trvání = 11 ms) pro akcelerace polovina sin. vlny podle IEC 60068-2-27

Dimensions

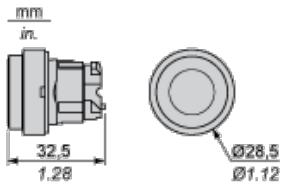

Panel Cut-out for Pushbuttons, Switches and Pilot Lights (Finished Holes, Ready for Installation)

Connection by Screw Clamp Terminals or Plug-in Connectors or on Printed Circuit Board	Connection by Faston Connectors
<p>(1) Diameter on finished panel or support</p> <p>(2) 40 mm min. / 1.57 in. min.</p> <p>(3) 30 mm min. / 1.18 in. min.</p> <p>(4) $\varnothing 22.5 \text{ mm} / 0.89 \text{ in.}$ recommended ($\varnothing 22.3 \text{ mm}_0^{+0.4} / 0.88 \text{ in.}_0^{+0.016}$)</p> <p>(5) 45 mm min. / 1.78 in. min.</p> <p>(6) 32 mm min. / 1.26 in. min.</p>	

Pushbuttons, Switches and Pilot Lights for Printed Circuit Board Connection

Panel Cut-outs (Viewed from Installer's Side)

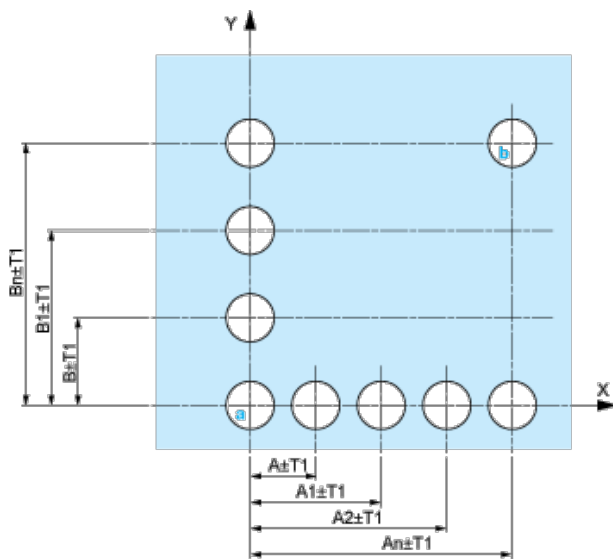

A: 30 mm min. / 1.18 in. min.

B: 40 mm min. / 1.57 in. min.

Printed Circuit Board Cut-outs (Viewed from Electrical Block Side)

Dimensions in mm

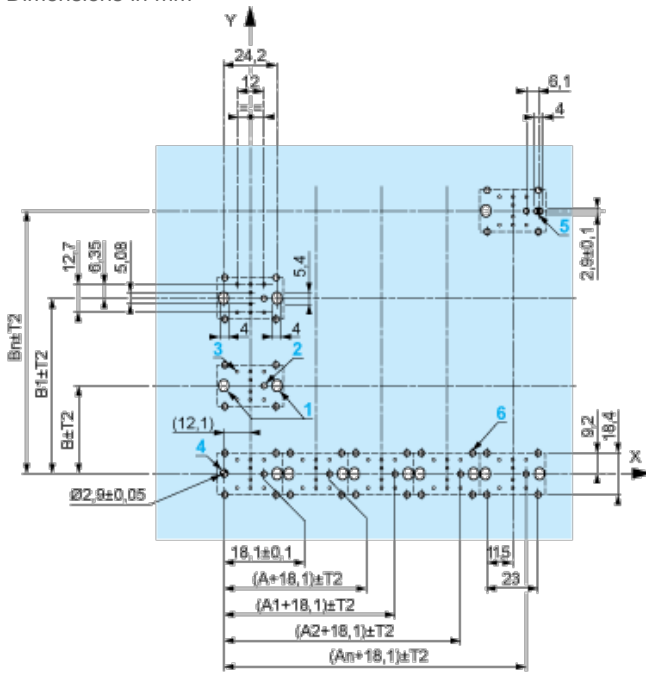

A: 30 mm min.

B: 40 mm min.

Dimensions in in.

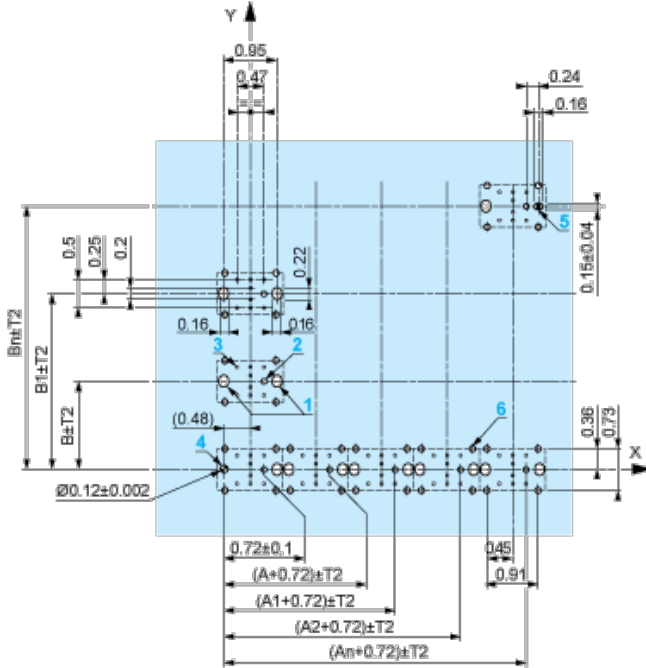

A: 1.18 in. min.

B: 1.57 in. min.

General Tolerances of the Panel and Printed Circuit Board

The cumulative tolerance must not exceed 0.3 mm / 0.012 in: $T1 + T2 = 0.3 \text{ mm max.}$

Installation Precautions

- ┆ Minimum thickness of circuit board: 1.6 mm / 0.06 in.
- ┆ Cut-out diameter: 22.4 mm \pm 0.1 / 0.88 in. \pm 0.004
- ┆ Orientation of body/fixing collar ZB4 BZ009: \pm 2°30' (excluding cut-outs marked **a** and **b**).
- ┆ Tightening torque of screws ZBZ 006: 0.6 N.m (5.3 lbf.in) max.
- ┆ Allow for one ZB4 BZ079 fixing collar/pillar and its fixing screws:
 - ┆ every 90 mm / 3.54 in. horizontally (X), and 120 mm / 4.72 in. vertically (Y).
 - ┆ with each selector switch head (ZB4 BD*, ZB4 BJ*, ZB4 BG*).

The fixing centers marked **a** and **b** are diagonally opposed and must align with those marked 4 and 5.



- (1) Panel
- (2) Printed circuit board

Mounting of Adapter (Socket) ZBZ 01•

- | 1 2 elongated holes for ZBZ 006 screw access
- | 2 1 hole \varnothing 2.4 mm \pm 0.05 / 0.09 in. \pm 0.002 for centring adapter ZBZ 01•
- | 3 8 \times \varnothing 1.2 mm / 0.05 in. holes
- | 4 1 hole \varnothing 2.9 mm \pm 0.05 / 0.11 in. \pm 0.002, for aligning the printed circuit board (with cut-out marked **a**)
- | 5 1 elongated hole for aligning the printed circuit board (with cut-out marked **b**)
- | 6 4 holes \varnothing 2.4 mm / 0.09 in. for clipping in adapter ZBZ 01•

Dimensions An + 18.1 relate to the \varnothing 2.4 mm \pm 0.05 / 0.09 in. \pm 0.002 holes for centring adapter ZBZ 01•.

Electrical Composition Corresponding to Code C1



Electrical Composition Corresponding to Code C2



Electrical Composition Corresponding to Codes C9, C11, SF1 and SR1



Electrical Composition Corresponding to Code C15

1 N/O

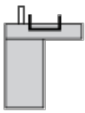

1 N/C

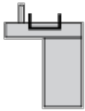

1 N/O + N/C or 1 N/O + N/O or 1 N/C + N/C

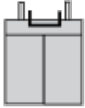

Legend

Single contact



Double contact



Light block



Possible location

