



Hlavní parametry

Řada	TeSys
Označení výrobku	TeSys GV2
Označení přístroje	GV2L
Použití zařízení	Motor
Popis pólů	3P
Typ sítě	AC
Kategorie použití	AC-3 podle IEC 60947-4-1 Kategorie A podle IEC 60947-2
Frekvence sítě	50/60 Hz podle IEC 60947-2
Vypínací schopnost	10 kA Icu při 500 V AC 50/60 Hz podle IEC 60947-2 20 kA Icu při 440 V AC 50/60 Hz podle IEC 60947-2 100 kA Icu při 230/240 V AC 50/60 Hz podle IEC 60947-2 100 kA Icu při 400/415 V AC 50/60 Hz podle IEC 60947-2 4 kA Icu při 690 V AC 50/60 Hz podle IEC 60947-2
[Ics] jmenovitá provozní zkratová vypínací schopnost	100 % při 230/240 V AC 50/60 Hz podle IEC 60947-2 100 % při 500 V AC 50/60 Hz podle IEC 60947-2 100 % při 690 V AC 50/60 Hz podle IEC 60947-2 75 % při 440 V AC 50/60 Hz podle IEC 60947-2 100 % při 400/415 V AC 50/60 Hz podle IEC 60947-2
Provedení jednotky spouští	Zkratová
Proud zkratové spouště	138 A

Doplňek

Upevnění	Clipped on 35 mm symmetrical DIN rail Šroubové na na panel (s 2 x M4 šrouby)
Pracovní poloha	Any position
Výkon motoru (kW)	3 kW při 400/415 V AC 50/60 Hz 4 kW při 400/415 V AC 50/60 Hz 4 kW při 500 V AC 50/60 Hz 7,5 kW při 690 V AC 50/60 Hz 5,5 kW při 690 V AC 50/60 Hz
Typ ovládání	Otočná páčka
[Ue] jmenovité pracovní napětí	690 V AC 50/60 Hz podle IEC 60947-2
[Ui] jmenovité izolační napětí	690 V AC 50/60 Hz podle IEC 60947-2
[Uimp] jmenovité impulzní výdržné napětí	6 kV podle IEC 60947-2
Ztrátový výkon na pól	1,8 W
Mechanická životnost	100000 cykly
Elektrická životnost	100000 cykly pro AC-3 při 415 V
Pracovní rozsah	40 cyk/h
Jmenovitý výkon	Spojité podle IEC 60947-4-1
Připojení - svorky	Screw clamp terminals 2 cable(s) 1...6 mm ² solid Screw clamp terminals 2 cable(s) 1.5...6 mm ² flexible without cable end Screw clamp terminals 2 cable(s) 1...4 mm ² flexible with cable end
Krouticí moment	1.7 N.m on screw clamp terminals
Mechanická robustnost	Rázy 30 Gn podle IEC 60068-2-27 Vibrace 5 Gn, 5...150 Hz podle IEC 60068-2-6

Vhodnost pro bezpečné odpojení	ANO podle IEC 60947-1
Citlivost na fáz.poruchu	ANO
Výška	89 mm
Šířka	45 mm
Hloubka	97 mm
Hmotnost přístroje	0,33 kg

Životní prostředí

standardy	EN 60204 IEC 60947-1 IEC 60947-2 NF C 63-120 NF C 63-650 NF C 79-130 VDE 0113 VDE 0660
certifikace výrobku	BV CCC CSA DNV GL LROS (Lloyds register of shipping) RINA
použití ochrany	TH
stupeň ochrany IK	IK04
teplota okolního vzduchu pro provoz	-20...60 °C
teplota okolí pro uskladnění	-40...80 °C
požární odolnost	960 °C podle IEC 60695-2-1
pracovní nadmořská výška	0...2000 m

Nabídka udržitelnosti

udržitelný stav nabídky	Výrobek Green Premium
RoHS	Compliant - since 0631 - Schneider Electric declaration of conformity
REACH	Odkaz obsahuje SVHC nad mezní hodnotou - přejít na CaP pro více informací
dokument o ekologickém profilu	Dostupný
instrukce o ukončení životnosti výrobku	Standardní recyklací výrobku

Contractual warranty

Záruční lhůta	18 měsíců
---------------	-----------

Tripping Curves for GV2L or LE Combined with Thermal Overload Relay LRD or LR2K

Average Operating Times at 20 °C Related to Multiples of the Setting Current



- 1 3 poles from cold state
- 2 2 poles from cold state
- 3 3 poles from hot state

Current Limitation on Short-Circuit for GV2L and GV2LE Only (3-Phase 400/415 V)

Dynamic Stress

$I_{peak} = f(\text{prospective } I_{sc}) \text{ at } 1.05 U_e = 435 \text{ V}$

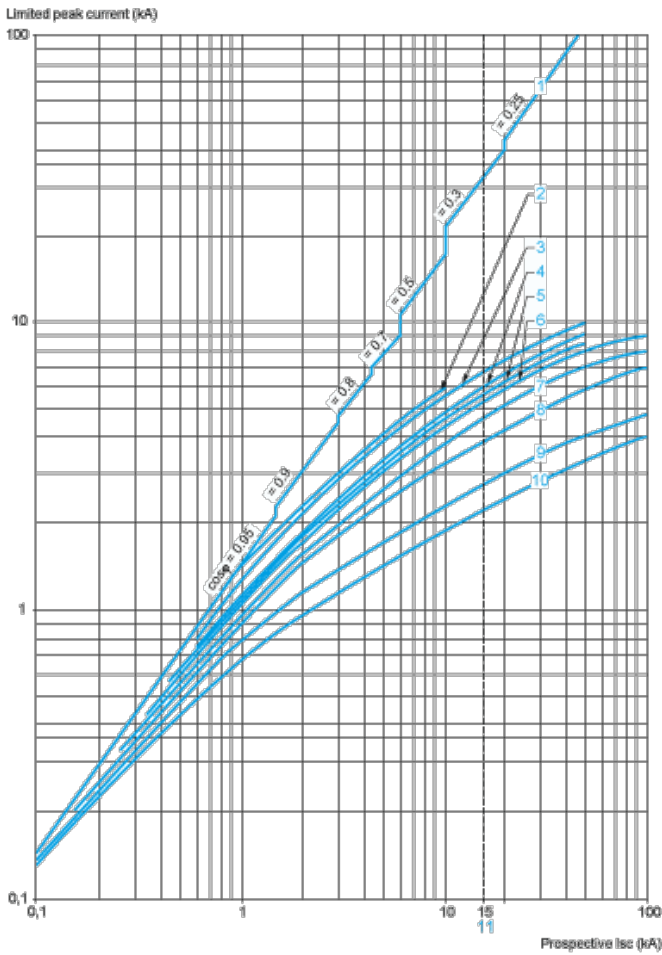

- 1 Maximum peak current
- 2 32 A
- 3 25 A
- 4 18 A
- 5 14 A
- 6 10 A
- 7 6.3 A
- 8 4 A
- 9 2.5 A
- 10 1.6 A
- 11 Limit of rated ultimate breaking capacity on short-circuit of GV2LE (14, 18, 23, and 25 A ratings).

Current Limitation on Short-Circuit for GV2L and GV2LE + Thermal Overload Relay LRD or LR2K (3-Phase 400/415 V)

Dynamic Stress

$I_{peak} = f(\text{prospective } I_{sc}) \text{ at } 1.05 U_e = 435 \text{ V}$



- 1 Maximum peak current
- 2 32 A
- 3 25 A
- 4 18 A
- 5 14 A
- 6 10 A
- 7 6.3 A
- 8 4 A
- 9 2.5 A
- 10 1.6 A
- 11 Limit of rated ultimate breaking capacity on short-circuit of GV2LE (14, 18, 23, and 25 A ratings).

Thermal Limit on Short-Circuit for GV2L Only

Thermal Limit in kA²s in the Magnetic Operating Zone

Sum of $I^2dt = f$ (prospective Isc) at 1.05 Ue = 435 V

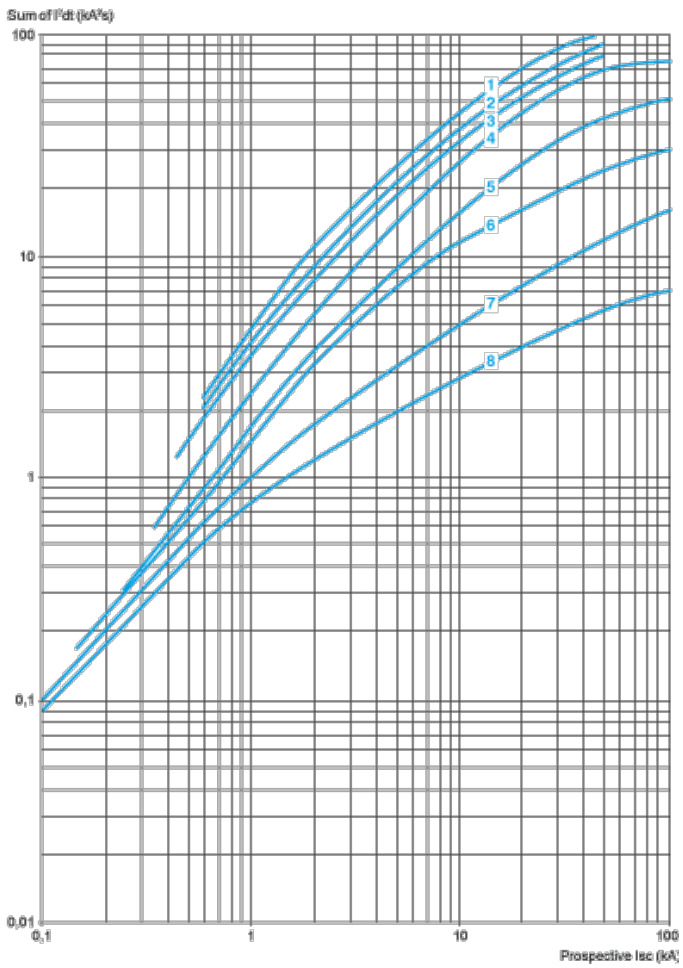

- 1 25 A and 32 A
- 2 18 A
- 3 14 A
- 4 10 A
- 5 6.3 A
- 6 4 A
- 7 2.5 A
- 8 1.6 A

Thermal Limit on Short-Circuit for GV2L and GV2LE + Thermal Overload Relay LRD or LR2K

Thermal Limit in kA²s in the Magnetic Operating Zone

Sum of $I^2dt = f$ (prospective Isc) at $1.05 U_e = 435 V$



- 1 32 A (GV2LE32)
- 2 25 A and 32 A (GV2L32)
- 3 18 A
- 4 14 A
- 5 10 A
- 6 6.3 A
- 7 4 A
- 8 2.5 A
- 9 1.6 A
- 10 Limit of rated ultimate breaking capacity on short-circuit of GV2 LE (14, 18, 23, and 25 A ratings).

GV2L

Dimensions

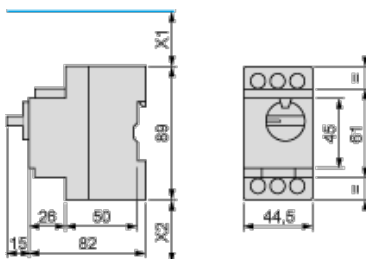

X1 Electrical clearance = 40 mm for $U_e \leq 415$ V, or 80 mm for $U_e = 440$ V, or 120 mm for $U_e = 500$ and 690 V.
 X2 = 40 mm.

GVAD, AM, AN, AU, AS

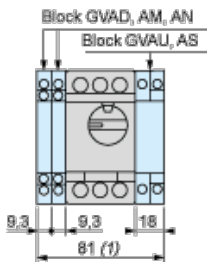

1 Maximum
GV2AK00

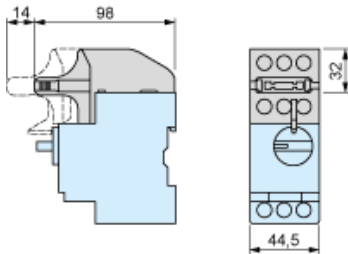

Mounting

On rail AM1 DE200, AM1 ED200 (35 x 15)

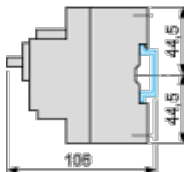

Panel mounted



On pre-slotted mounting plate AM1 PA

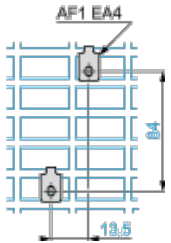

Adapter Plate GK2AF01

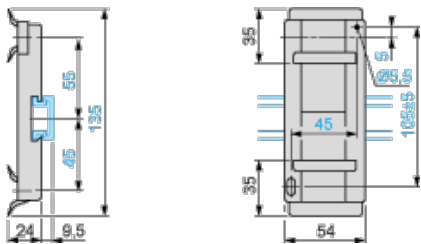

7.5 mm Height Compensation Plate GV1F03

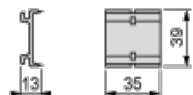

Mounting

Mounting of External Operator GV2APN01, GV2APN02 or GV2APN04 for Motor Circuit Breakers GV2L

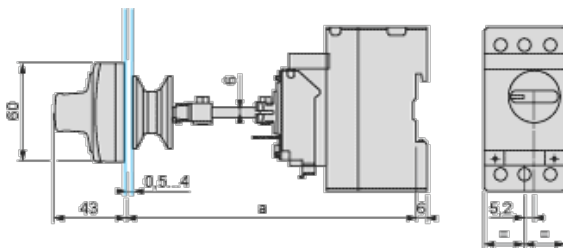

Door cut-out

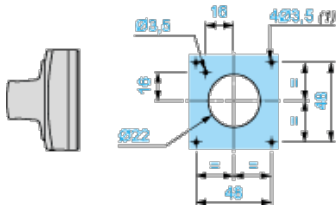

(1) For IP65 only.

Mounting of External Operator GVAPH02 for Motor Circuit Breakers GV2L

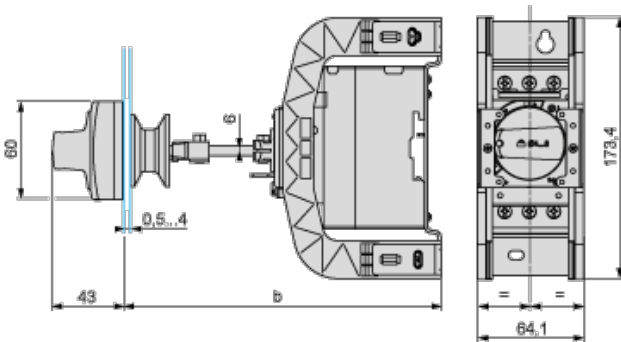

	b	
	Minimum	Maximum
GV2 APN.. + GV APH02	151	250
GV2 APN.. + GV APH02 + GV APK11	250	445

Door cut-out

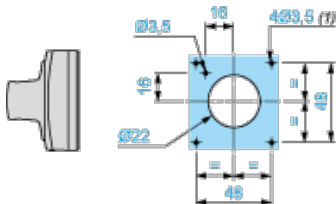

(1) For IP65 only.

GV2L and GV2LE

Sets of busbars GV2G445, GV2G454, GV2G472, with terminal block GV2G05

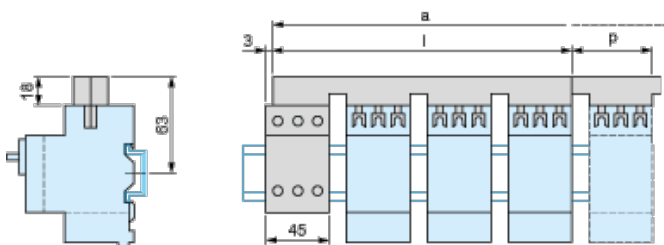

	l	p
GV2G445 (4 x 45 mm)	179	45
GV2G454 (4 x 54 mm)	206	54
GV2G472 (4 x 72 mm)	260	72

Number of tap-offs	a			
	5	6	7	8

GV2G445	224	269	314	359
GV2G454	260	314	368	422
GV2G472	332	404	476	548

Sets of Busbars for GV2L and GV2LE

Sets of busbars GV2G... with terminal block GV1G09

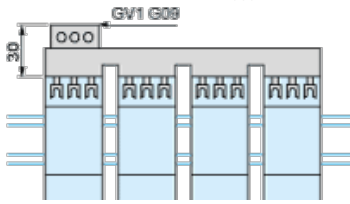

Sets of busbars GV2G245, GV2G254, GV2GR272

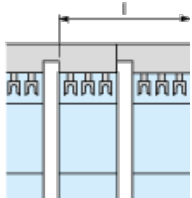

	I
GV2G245 (2 x 45 mm)	89
GV2G254 (2 x 54 mm)	98
GV2G272 (2 x 72 mm)	116

Set of busbars GV2G554

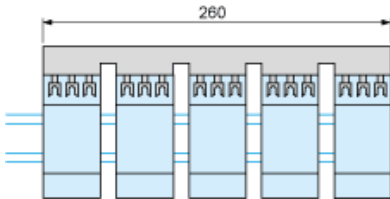

Sets of busbars GV2G345 and GV2G354

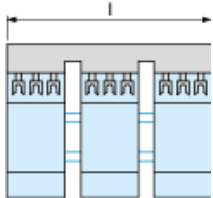

	I
GV2G345 (3 x 45 mm)	134
GV2G354 (3 x 54 mm)	152

GV2L••

