



# PROFILO<sub>A</sub>



- 📁 19160 PROFILO A
- 📁 19170 SHADE A-FR
- 📁 19190 HANDLE A

- profil / profil
- difuzor / difúzor
- držák / držiak

- 🔩 eloxovaný hliník / eloxovaný hliník
- 🔩 transparentní / transparentný
- 🔩 nerez / nerez

PROFILO B - SMALL SURFACE ALUMINIUM PROFILE

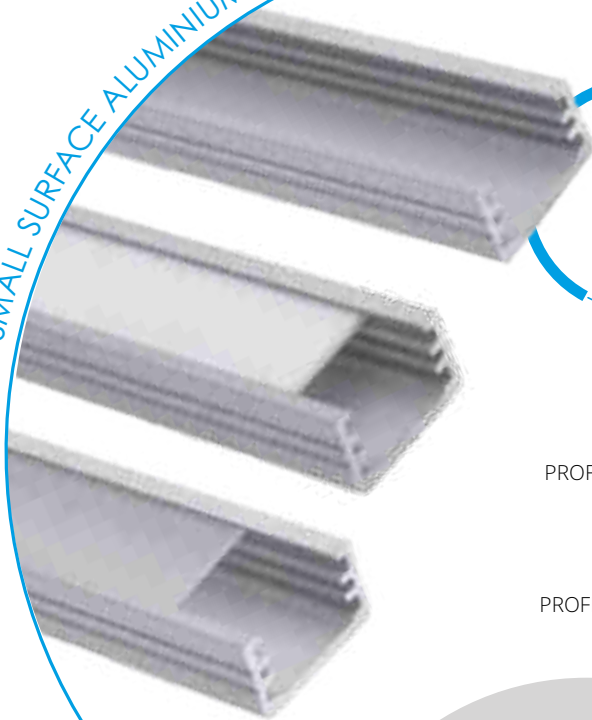

PROFILO B

PROFILO B + SHADE B/F-W

PROFILO B + SHADE B/F-FR

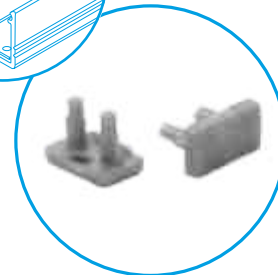
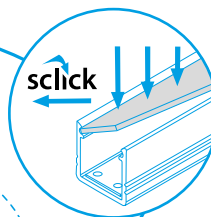

# PROFILO<sub>B</sub>

I=1000/2000



hliník

I=1000/2000



sclick



- 📁 19161 PROFILO B
- 📁 26540 PROFILO B 2M
- 📁 26568 SHADE B/F-FR
- 📁 26569 SHADE B/F-W
- 📁 26570 SHADE B/F-FR 2M
- 📁 26571 SHADE B/F-W 2M
- 📁 26596 HANDLE B/F
- 📁 26604 CONNECT-L B
- 📁 19181 STOPPER B

- profil / profil
- profil / profil
- difuzor / difúzor
- difuzor / difúzor
- difuzor / difúzor
- difuzor / difúzor
- držák / držiak
- spojka / spojka
- záslepka / záslepka

- 🌀 eloxovaný hliník / eloxovaný hliník
- 🌀 eloxovaný hliník / eloxovaný hliník
- 🌀 transparentní / transparentný
- 🌀 bílá / biela
- 🌀 transparentní / transparentný
- 🌀 bílá / biela
- 🌀 nerez / nerez
- 🌀 hliník / hliník
- 🌀 šedá / šedá



PROFILO C - CORNER ALUMINIUM PROFILE (ANGULAR 30°, 60°)

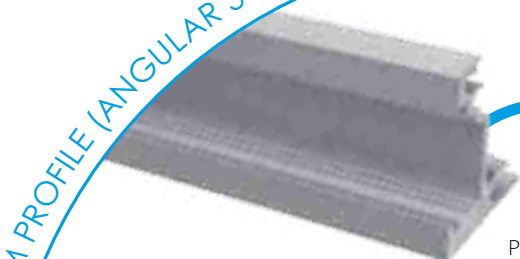

PROFILO c

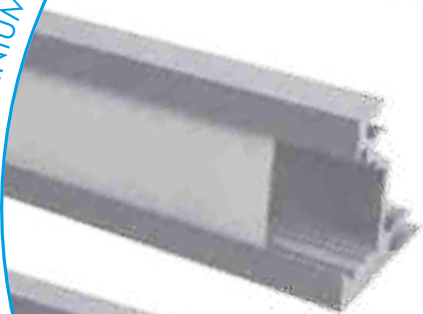

PROFILO c + SHADE c/D/E/I-W

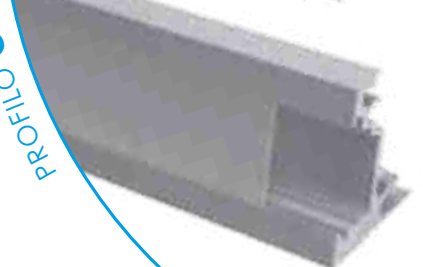

PROFILO c + SHADE c/D/E/I-FR

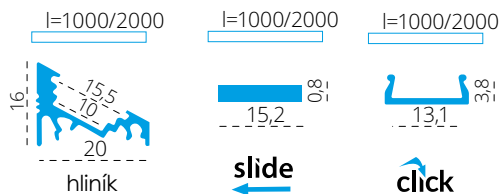
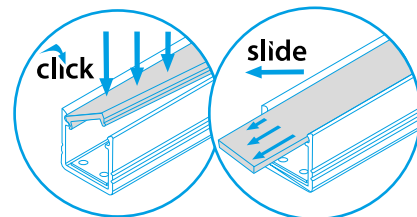
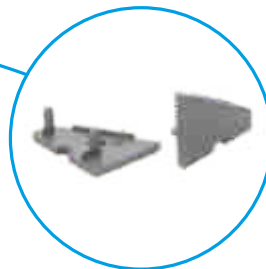

# PROFILO<sub>C</sub>

- }

19162 PROFILO C

26541 PROFILO C 2M
- {

26572 SHADE C/D/E/I-FR

26573 SHADE C/D/E/I-FR 2M

26574 SHADE C/D/E/I-W

26575 SHADE C/D/E/I-W 2M
- {

26576 SHADE CK C/D/E/I-FR

26577 SHADE CK C/D/E/I-FR2M

26578 SHADE CK C/D/E/I-W

26579 SHADE CK C/D/E/I-W 2M
- 19182 STOPPER C

19191 HANDLE C/D/E

26562 CONNECT-L C

26597 HANDLE C/D/E/I

- |                     |                                     |
|---------------------|-------------------------------------|
| profil / profil     | eloxovaný hliník / eloxovaný hliník |
| profil / profil     | eloxovaný hliník / eloxovaný hliník |
| difuzor / difúzor   | transparentní / transparentný       |
| difuzor / difúzor   | transparentní / transparentný       |
| difuzor / difúzor   | bílá / biela                        |
| difuzor / difúzor   | bílá / biela                        |
| difuzor / difúzor   | transparentní / transparentný       |
| difuzor / difúzor   | transparentní / transparentný       |
| difuzor / difúzor   | bílá / biela                        |
| difuzor / difúzor   | bílá / biela                        |
| záslepka / záslepka | šedá / šedá                         |
| držák / držiak      | nerez / nerez                       |
| spojka / spojka     | hliník / hliník                     |
| držák / držiak      | hliník / hliník                     |

PROFILO D - SURFACE ALUMINIUM PROFILE



PROFILO D

PROFILO D + SHADE c/D/E/I-W

PROFILO D + SHADE c/D/E/I-FR

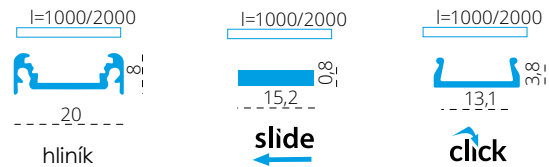

# PROFILO<sub>D</sub>

slide	19163	PROFILO D	profil / profil	eloxovaný hliník / eloxovaný hliník
	26542	PROFILO D 2M	profil / profil	eloxovaný hliník / eloxovaný hliník
	26572	SHADE C/D/E/I-FR	difuzor / difúzor	transparentní / transparentný
	26573	SHADE C/D/E/I-FR 2M	difuzor / difúzor	transparentní / transparentný
	26574	SHADE C/D/E/I-W	difuzor / difúzor	bílá / biela
click	26575	SHADE C/D/E/I-W 2M	difuzor / difúzor	bílá / biela
	26576	SHADE CK C/D/E/I-FR	difuzor / difúzor	transparentní / transparentný
	26577	SHADE CK C/D/E/I-FR2M	difuzor / difúzor	transparentní / transparentný
	26578	SHADE CK C/D/E/I-W	difuzor / difúzor	bílá / biela
	26579	SHADE CK C/D/E/I-W 2M	difuzor / difúzor	bílá / biela
	19183	STOPPER D	záslepka / záslepka	šedá / šedá
	26597	HANDLE C/D/E/I	držák / držiak	nerez / nerez
	26563	CONNECT C/D/E/I	spojka / spojka	hliník / hliník



PROFILO E - ANGULAR 45°

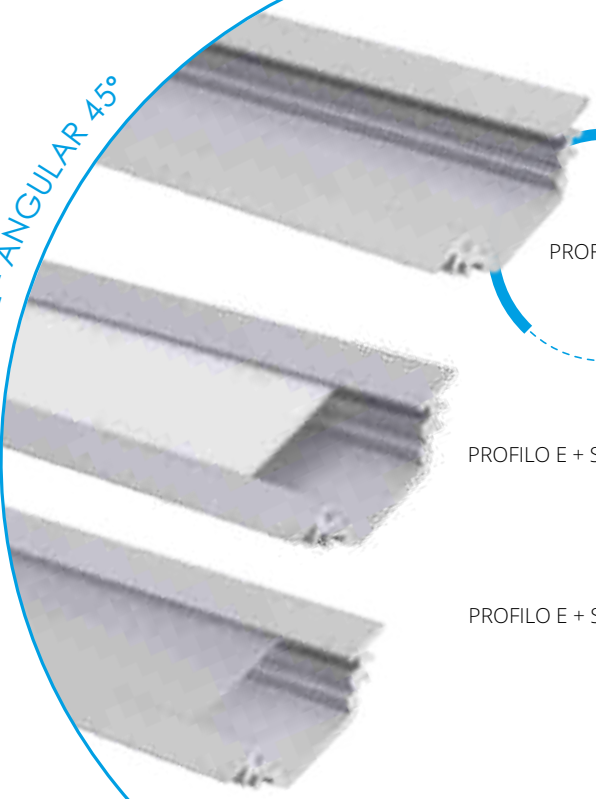

PROFILO E

PROFILO E + SHADE C/D/E/I-W

PROFILO E + SHADE C/D/E/I-FR

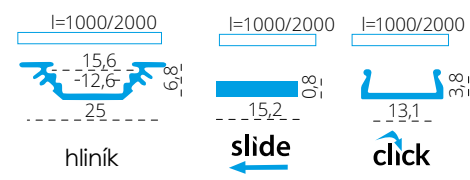
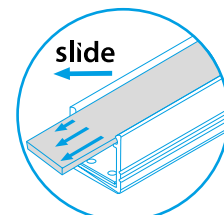
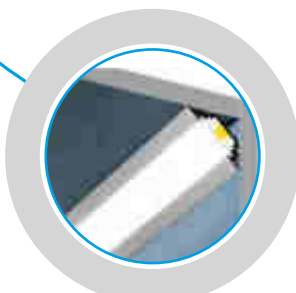

# PROFILO<sub>E</sub>

slide	19164	PROFILO E	profil / profil	eloxovaný hliník / eloxovaný hliník	
	26543	PROFILO E 2M	profil / profil	eloxovaný hliník / eloxovaný hliník	
	26572	SHADE C/D/E/I-FR	difúzor / difúzor	transparentní / transparentný	
	26573	SHADE C/D/E/I-FR 2M	difúzor / difúzor	transparentní / transparentný	
	26574	SHADE C/D/E/I-W	difúzor / difúzor	bílá / biela	
	26575	SHADE C/D/E/I-W 2M	difúzor / difúzor	bílá / biela	
	click	26576	SHADE CK C/D/E/I-FR	difúzor / difúzor	transparentní / transparentný
		26577	SHADE CK C/D/E/I-FR2M	difúzor / difúzor	transparentní / transparentný
		26578	SHADE CK C/D/E/I-W	difúzor / difúzor	bílá / biela
		26579	SHADE CK C/D/E/I-W 2M	difúzor / difúzor	bílá / biela
	19184	STOPPER E	záslepka / záslepka	šedá / šedá	
	26597	HANDLE C/D/E	držák / držiak	nerez / nerez	
	26563	CONNECT C/D/E	spojka / spojka	hliník / hliník	

PROFILO F - TALL SURFACE ALUMINIUM PROFILE



PROFILO F

PROFILO F + SHADE B/F-W

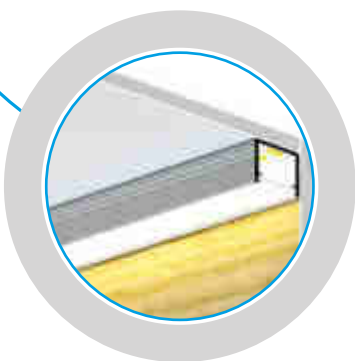
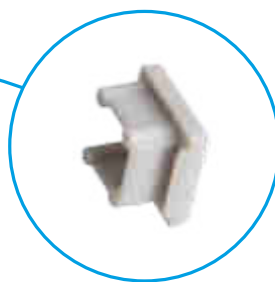

# PROFILO<sub>F</sub>

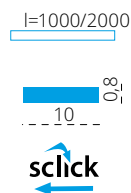
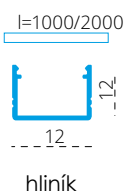

- 📁 **26552** PROFILO F
- 📁 **26553** PROFILO F 2M
- 📁 **26568** SHADE B/F-FR
- 📁 **26570** SHADE B/F-FR 2M
- 📁 **26569** SHADE B/F-W
- 📁 **26571** SHADE B/F-W 2M
- 📁 **26590** STOPPER F
- 📁 **26596** HANDLE B/F

- profil / profil
- profil / profil
- difuzor / difúzor
- difuzor / difúzor
- difuzor / difúzor
- difuzor / difúzor
- záslepka / záslepka
- držák / držiak

- 🌀 eloxovaný hliník / eloxovaný hliník
- 🌀 eloxovaný hliník / eloxovaný hliník
- 🌀 transparentní / transparentný
- 🌀 transparentní / transparentný
- 🌀 bílá / biela
- 🌀 bílá / biela
- 🌀 šedá / šedá
- 🌀 nerez / nerez

PROFILO G - RECESSED FLOOR ALUMINIUM PROFILE



PROFILO G + SHADE CK G

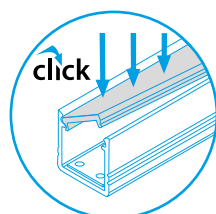
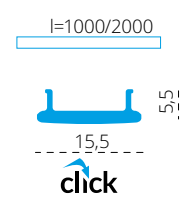
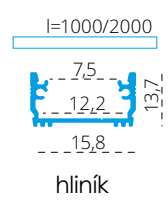
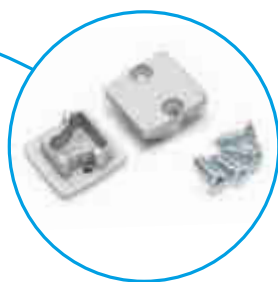

# PROFILO<sub>G</sub>

- }
click
  - ▢
**26558** PROFILO G
  - ▢
**26559** PROFILO G 2M
  - ▢
**26580** SHADE CK G
  - ▢
**26581** SHADE CK G 2M
  - ▢
**26592** STOPPER G
  - ▢
**26598** HANDLE G
  - ▢
**26602** SEALINGS G

- profil / profil
- profil / profil
- difúzor / difúzor
- difúzor / difúzor
- záslepka / záslepka
- držák / držiak
- tesnení / tesnenie

- ⊗
 eloxovaný hliník / eloxovaný hliník
- ⊗
 eloxovaný hliník / eloxovaný hliník
- ⊗
 bílá / biela
- ⊗
 bílá / biela
- ⊗
 šedá / šedá
- ⊗
 nerez / nerez
- ⊗
 šedá / šedá

PROFILO H - FLEXIBLE ALUMINIUM PROFILE

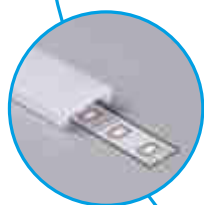

PROFILO H + SHADE Ø H-W

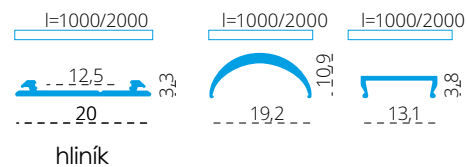
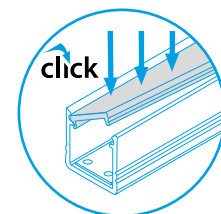

# PROFILO<sub>H</sub>

click	26560	PROFILO H	profil / profil	eloxovaný hliník / eloxovaný hliník
	26561	PROFILO H 2M	profil / profil	eloxovaný hliník / eloxovaný hliník
	26582	SHADE-U H-FR	difuzor / difúzor	transparentní / transparentný
	26583	SHADE-U H-FR 2M	difuzor / difúzor	transparentní / transparentný
	26584	SHADE-U H-W	difuzor / difúzor	bílá / biela
	26585	SHADE-U H-W 2M	difuzor / difúzor	bílá / biela
	26586	SHADE-O H-W	difuzor / difúzor	bílá / biela
	26587	SHADE-O H-W 2M	difuzor / difúzor	bílá / biela
	26593	STOPPER-U H	záslepka / záslepka	šedá / šedá
	26594	STOPPER-O H	záslepka / záslepka	šedá / šedá
	26599	HANDLE H	držák / držiak	nerez / nerez
	26600	HANDLE SIDE H	držák / držiak	šedá / šedá





PROFILO I - A RECESSED PROFILE WHICH CAN GIVE COUNTINOUS LINE EFFECT

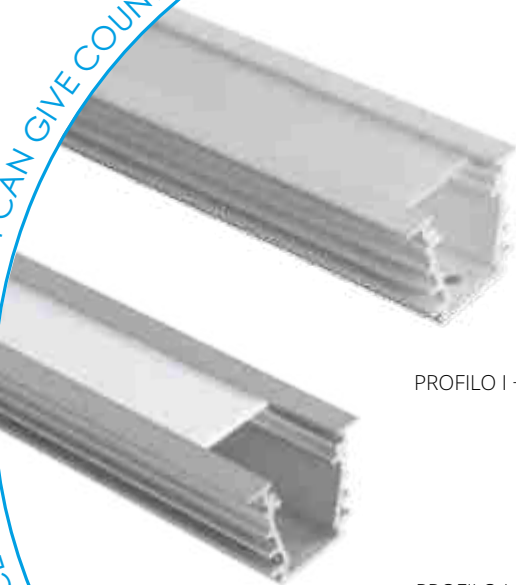

PROFILO I + SHADE c/D/E/I-FR

PROFILO I + SHADE c/D/E/I-W

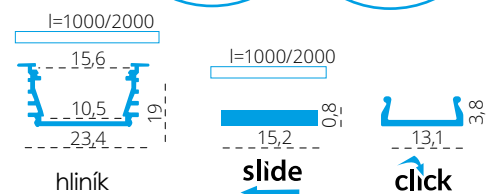
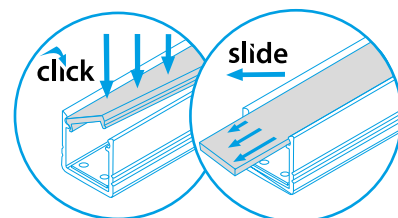
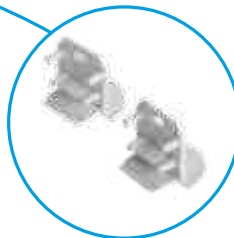

# PROFILO I

slide	26554	PROFILO I	profil / profil	eloxovaný hliník / eloxovaný hliník
	26555	PROFILO I 2M	profil / profil	eloxovaný hliník / eloxovaný hliník
	26556	PROFILO I-W	difúzor / difúzor	bílá / biela
	26557	PROFILO I-W 2M	difúzor / difúzor	bílá / biela
	26572	SHADE C/D/E/I-FR	difúzor / difúzor	transparentní / transparentný
	26573	SHADE C/D/E/I-FR 2M	difúzor / difúzor	transparentní / transparentný
	26574	SHADE C/D/E/I-W	difúzor / difúzor	bílá / biela
	26575	SHADE C/D/E/I-W 2M	difúzor / difúzor	bílá / biela
	26576	SHADE CK C/D/E/I-FR	difúzor / difúzor	transparentní / transparentný
	26577	SHADE CK C/D/E/I-FR2M	difúzor / difúzor	transparentní / transparentný
click	26578	SHADE CK C/D/E/I-W	difúzor / difúzor	bílá / biela
	26579	SHADE CK C/D/E/I-W 2M	difúzor / difúzor	bílá / biela
	26591	STOPPER I	záslepka / záslepka	šedá / šedá
	26603	STOPPER I-W	záslepka / záslepka	bílá / biela
	26563	CONNECT C/D/E/I	spojka / spojka	hliník / hliník
	26597	HANDLE C/D/E/I	držák / držiak	nerez / nerez
	26601	SPRING I	držák do SDK / držiak do SDK	hliník / hliník

PROFILO J - BASIC SURFACE ALUMINIUM PROFILE



PROFILO j

PROFILO j-W 2m



# PROFILO<sub>J</sub>

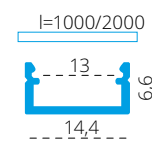

hliník

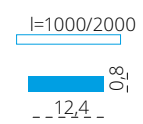

sclick

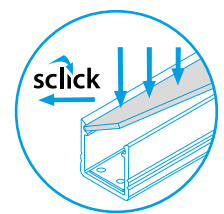

- 📁 26544 PROFILO J
- 📁 26545 PROFILO J 2M
- 📁 26546 PROFILO J-W
- 📁 26547 PROFILO J-W 2M
- 📁 26564 SHADE J/K-FR
- 📁 26566 SHADE J/K-FR 2M
- 📁 26565 SHADE J/K-W
- 📁 26567 SHADE J/K-W 2M
- 📁 26588 STOPPER J
- 📁 26605 STOPPER J-W
- 📁 26595 HANDLE J/K

- profil / profil
- profil / profil
- profil / profil
- profil / profil
- difúzor / difúzor
- difúzor / difúzor
- difúzor / difúzor
- difúzor / difúzor
- záslepka / záslepka
- záslepka / záslepka
- držák / držiak

- 🌀 eloxovaný hliník / eloxovaný hliník
- 🌀 eloxovaný hliník / eloxovaný hliník
- 🌀 bílá / biela
- 🌀 bílá / biela
- 🌀 transparentní / transparentný
- 🌀 transparentní / transparentný
- 🌀 bílá / biela
- 🌀 bílá / biela
- 🌀 šedá / šedá
- 🌀 bílá / biela
- 🌀 nerez / nerez

PROFILO K - SMALL RECESSED ALUMINIUM PROFILE

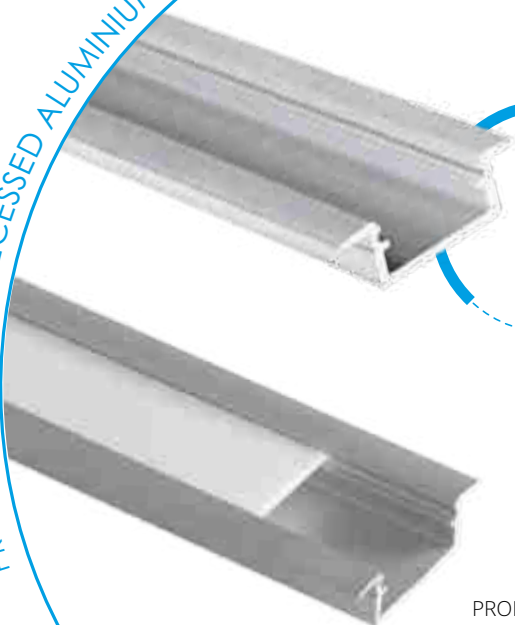

PROFILO K

PROFILO K + SHADE j/K-W

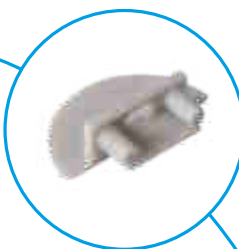

# PROFILO<sub>K</sub>

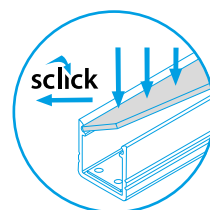
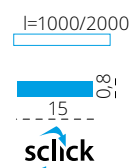
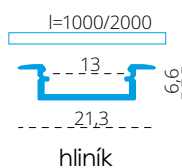

<b>26548</b> PROFILO K	profil / profil	eloxovaný hliník / eloxovaný hliník
<b>26549</b> PROFILO K 2M	profil / profil	eloxovaný hliník / eloxovaný hliník
<b>26550</b> PROFILO K-W	profil / profil	bílá / biela
<b>26551</b> PROFILO K-W 2M	profil / profil	bílá / biela
<b>26564</b> SHADE J/K-FR	difuzor / difúzor	transparentní / transparentný
<b>26566</b> SHADE J/K-FR 2M	difuzor / difúzor	transparentní / transparentný
<b>26565</b> SHADE J/K-W	difuzor / difúzor	bílá / biela
<b>26567</b> SHADE J/K-W 2M	difuzor / difúzor	bílá / biela
<b>26589</b> STOPPER K	záslepka / záslepka	šedá / šedá
<b>26606</b> STOPPER K-W	záslepka / záslepka	bílá / biela
<b>26595</b> HANDLE J/K	držák / držiak	nerez / nerez