

Nosný profil

Materiál:

Ocel, zinkovaná metodou
 Sendzimira PN-EN 10327:2005

Na poptávku:

F – Žárový zinek dle EN ISO 1461
 E – Nerez
 L – Lakovaný dle vzorníku RAL

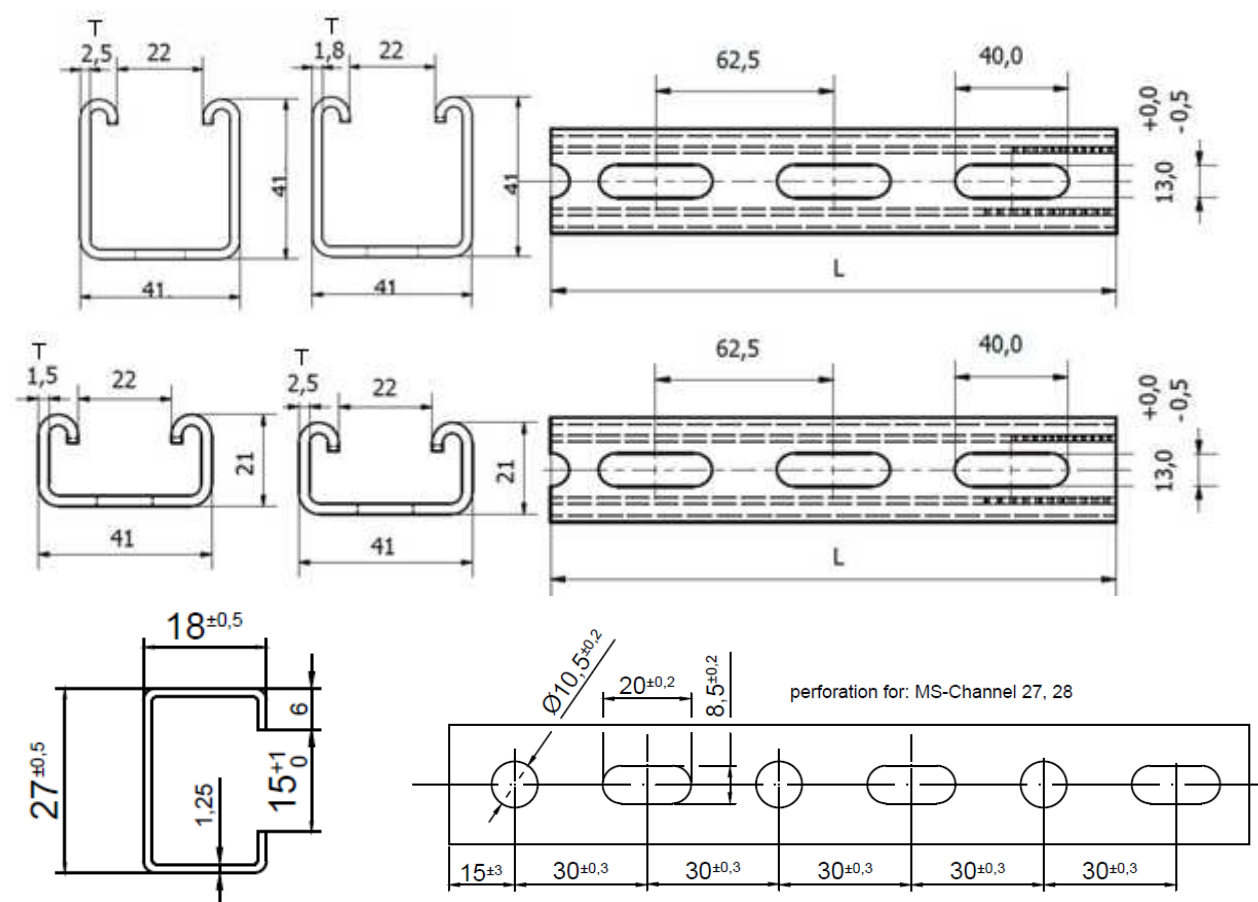
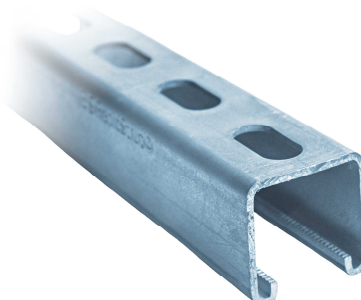

Kód	Popis	Rozměr profilu (mm)	Délka (m)	Balení	MJ
HL NP41H21/3	Profil nosný 41x21 mm, plech 1,5 mm, délka 3 m, pozink	41x21	3	1	ks
HL NP41H41/3	Profil nosný 41x41 mm, plech 1,8 mm, délka 3 m, pozink	41x41	3	1	ks
HL NP27H18/3	Profil nosný 27x18 mm, plech 1,25 mm, délka 3 m, pozink	27x18	3	1	ks
HL NP41H21x2,5	Profil nosný 41x21 mm, plech 2,5 mm, délka 3 m, pozink	41x21	3	1	ks
HL NP41H41x2,5	Profil nosný 41x41 mm, plech 2,5 mm, délka 3 m, pozink	41x41	3	1	ks

NOSNÍK 41/41 x 2,5 mm

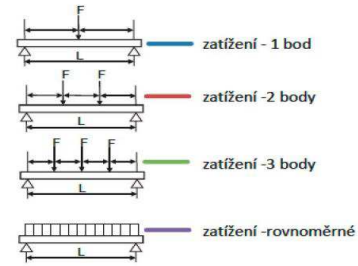
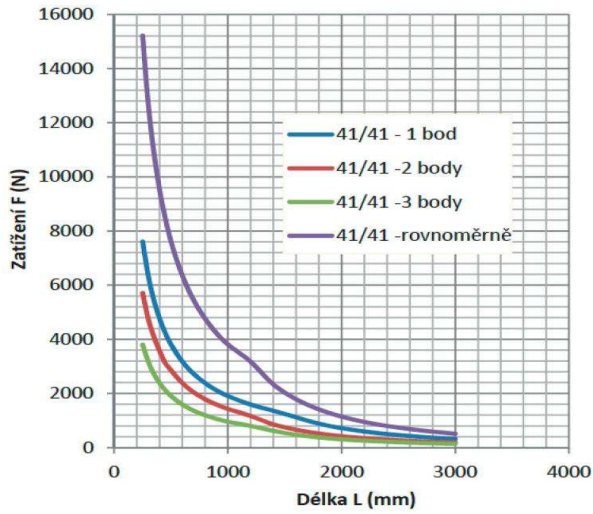

NOSNÍK 41/21 x 2,5 mm

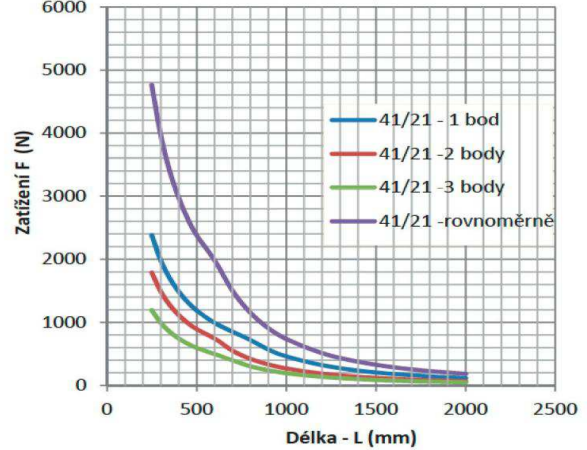

NOSNÍK 41/41 x 1,8 mm

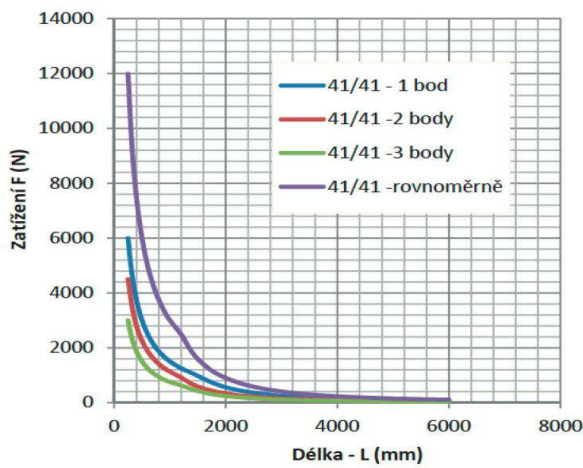

Nosník 41/21 x 1,5

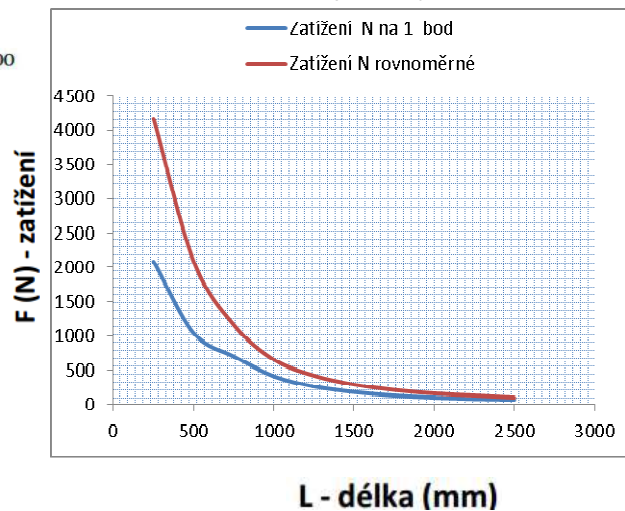

NOSNÍK 27/18 x 1,25 mm

