

# PROFILO<sub>A</sub>



- 📁 **19160** PROFILO A
- 📁 **19170** SHADE A-FR
- 📁 **19190** HANDLE A

- profil / profil
- difúzor / difúzor
- držák / držiak

- 🔩 eloxovaný hliník / eloxovaný hliník
- 🔩 transparentní / transparentný
- 🔩 nerez / nerez

PROFILO B - SMALL SURFACE ALUMINIUM PROFILE

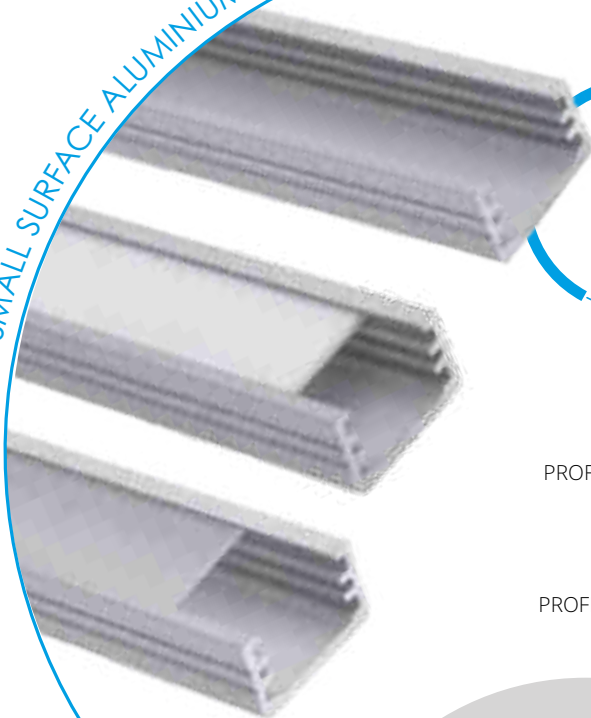

PROFILO B

PROFILO B + SHADE B/F-W

PROFILO B + SHADE B/F-FR

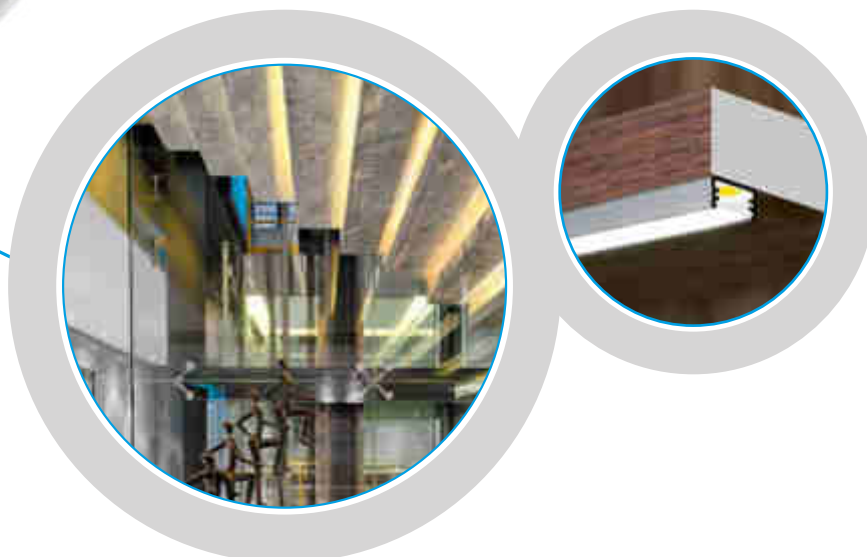
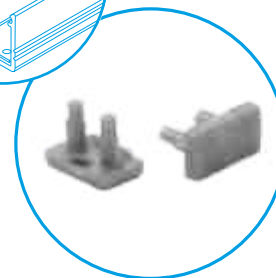
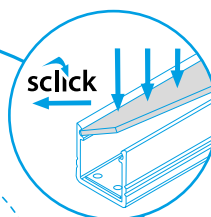

# PROFILO<sub>B</sub>

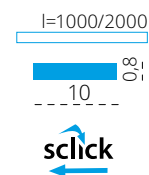
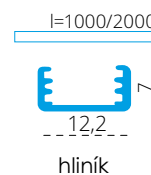

- 📁 19161 PROFILO B
- 📁 26540 PROFILO B 2M
- 📁 26568 SHADE B/F-FR
- 📁 26569 SHADE B/F-W
- 📁 26570 SHADE B/F-FR 2M
- 📁 26571 SHADE B/F-W 2M
- 📁 26596 HANDLE B/F
- 📁 26604 CONNECT-L B
- 📁 19181 STOPPER B

- profil / profil
- profil / profil
- difuzor / difúzor
- difuzor / difúzor
- difuzor / difúzor
- difuzor / difúzor
- držák / držiak
- spojka / spojka
- záslepka / záslepka

- 🌀 eloxovaný hliník / eloxovaný hliník
- 🌀 eloxovaný hliník / eloxovaný hliník
- 🌀 transparentní / transparentný
- 🌀 bílá / biela
- 🌀 transparentní / transparentný
- 🌀 bílá / biela
- 🌀 nerez / nerez
- 🌀 hliník / hliník
- 🌀 šedá / šedá

PROFILO C - CORNER ALUMINIUM PROFILE (ANGULAR 30°, 60°)

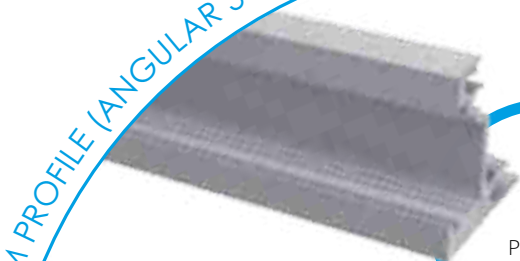

PROFILO c

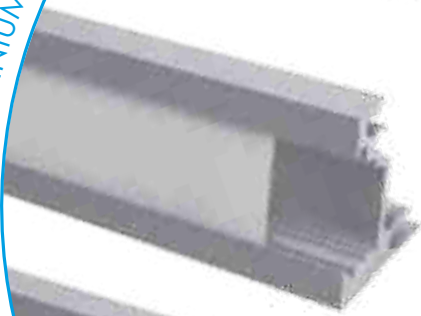

PROFILO c + SHADE c/D/E/I-W

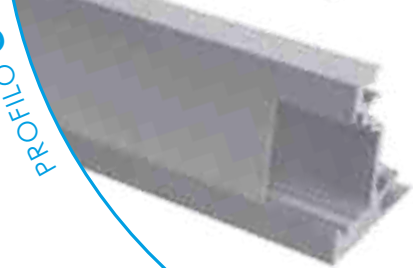

PROFILO c + SHADE c/D/E/I-FR

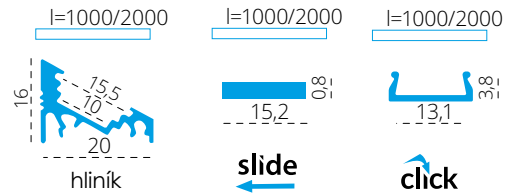
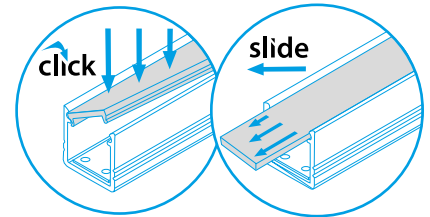
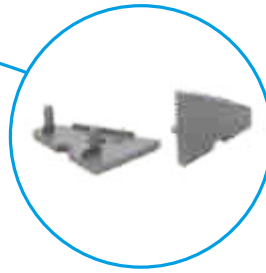

# PROFILO<sub>C</sub>

|       |       |                       |                     |                                     |
|-------|-------|-----------------------|---------------------|-------------------------------------|
| slide | 19162 | PROFILO C             | profil / profil     | eloxovaný hliník / eloxovaný hliník |
|       | 26541 | PROFILO C 2M          | profil / profil     | eloxovaný hliník / eloxovaný hliník |
|       | 26572 | SHADE C/D/E/I-FR      | difuzor / difúzor   | transparentní / transparentný       |
|       | 26573 | SHADE C/D/E/I-FR 2M   | difuzor / difúzor   | transparentní / transparentný       |
|       | 26574 | SHADE C/D/E/I-W       | difuzor / difúzor   | bílá / biela                        |
|       | 26575 | SHADE C/D/E/I-W 2M    | difuzor / difúzor   | bílá / biela                        |
| click | 26576 | SHADE CK C/D/E/I-FR   | difuzor / difúzor   | transparentní / transparentný       |
|       | 26577 | SHADE CK C/D/E/I-FR2M | difuzor / difúzor   | transparentní / transparentný       |
|       | 26578 | SHADE CK C/D/E/I-W    | difuzor / difúzor   | bílá / biela                        |
|       | 26579 | SHADE CK C/D/E/I-W 2M | difuzor / difúzor   | bílá / biela                        |
|       | 19182 | STOPPER C             | záslepka / záslepka | šedá / šedá                         |
|       | 19191 | HANDLE C/D/E          | držák / držiak      | nerez / nerez                       |
|       | 26562 | CONNECT-L C           | spojka / spojka     | hliník / hliník                     |
|       | 26597 | HANDLE C/D/E/I        | držák / držiak      | hliník / hliník                     |

PROFILO D - SURFACE ALUMINIUM PROFILE

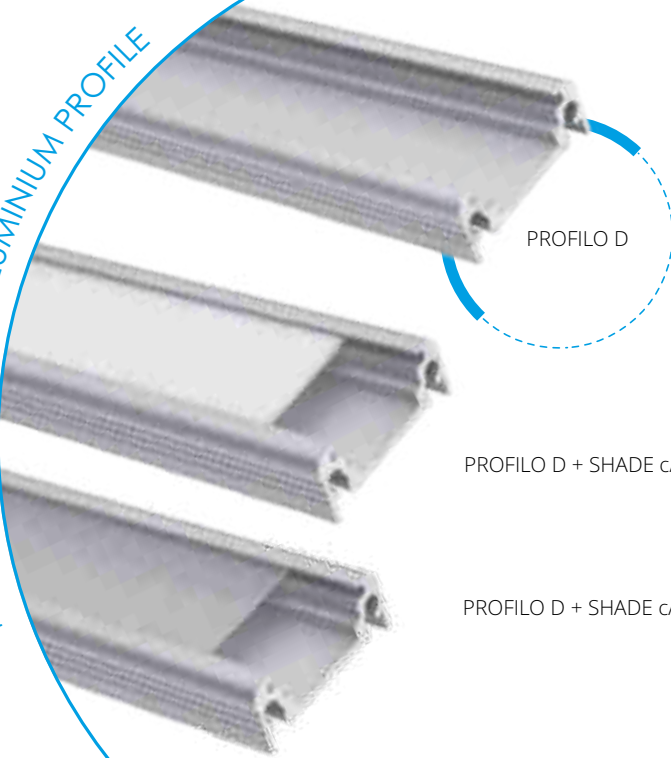

PROFILO D

PROFILO D + SHADE c/D/E/I-W

PROFILO D + SHADE c/D/E/I-FR

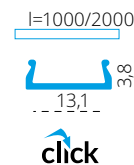
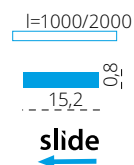
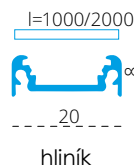
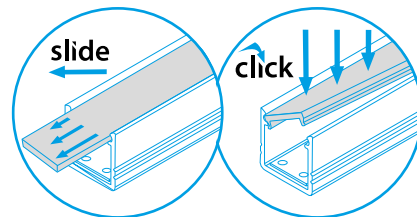
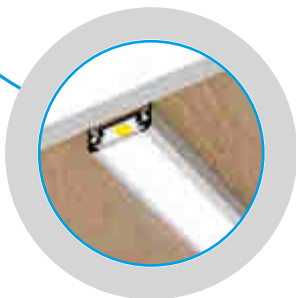

# PROFILO<sub>D</sub>

|       |       |                       |                     |                                     |
|-------|-------|-----------------------|---------------------|-------------------------------------|
| slide | 19163 | PROFILO D             | profil / profil     | eloxovaný hliník / eloxovaný hliník |
|       | 26542 | PROFILO D 2M          | profil / profil     | eloxovaný hliník / eloxovaný hliník |
|       | 26572 | SHADE C/D/E/I-FR      | difuzor / difúzor   | transparentní / transparentný       |
|       | 26573 | SHADE C/D/E/I-FR 2M   | difuzor / difúzor   | transparentní / transparentný       |
|       | 26574 | SHADE C/D/E/I-W       | difuzor / difúzor   | bílá / biela                        |
| click | 26575 | SHADE C/D/E/I-W 2M    | difuzor / difúzor   | bílá / biela                        |
|       | 26576 | SHADE CK C/D/E/I-FR   | difuzor / difúzor   | transparentní / transparentný       |
|       | 26577 | SHADE CK C/D/E/I-FR2M | difuzor / difúzor   | transparentní / transparentný       |
|       | 26578 | SHADE CK C/D/E/I-W    | difuzor / difúzor   | bílá / biela                        |
|       | 26579 | SHADE CK C/D/E/I-W 2M | difuzor / difúzor   | bílá / biela                        |
|       | 19183 | STOPPER D             | záslepka / záslepka | šedá / šedá                         |
|       | 26597 | HANDLE C/D/E/I        | držák / držiak      | nerez / nerez                       |
|       | 26563 | CONNECT C/D/E/I       | spojka / spojka     | hliník / hliník                     |



PROFILO E - ANGULAR 45°

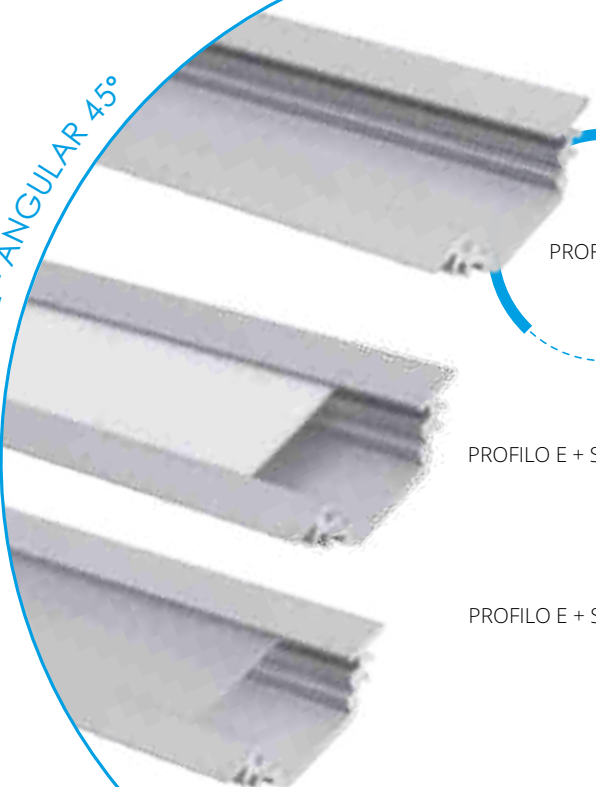

PROFILO E

PROFILO E + SHADE C/D/E/I-W

PROFILO E + SHADE C/D/E/I-FR

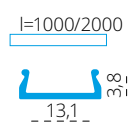
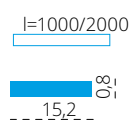
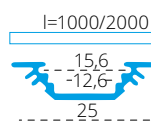
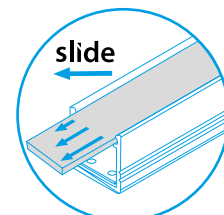
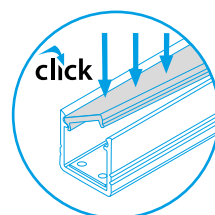
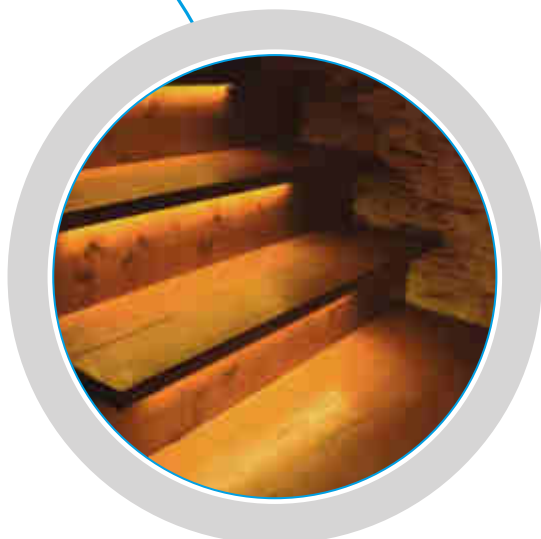

hliník

slide

click

# PROFILO<sub>E</sub>

|       |       |                       |                     |                                     |
|-------|-------|-----------------------|---------------------|-------------------------------------|
| slide | 19164 | PROFILO E             | profil / profil     | eloxovaný hliník / eloxovaný hliník |
|       | 26543 | PROFILO E 2M          | profil / profil     | eloxovaný hliník / eloxovaný hliník |
|       | 26572 | SHADE C/D/E/I-FR      | difúzor / difúzor   | transparentní / transparentný       |
|       | 26573 | SHADE C/D/E/I-FR 2M   | difúzor / difúzor   | transparentní / transparentný       |
|       | 26574 | SHADE C/D/E/I-W       | difúzor / difúzor   | bílá / biela                        |
| click | 26575 | SHADE C/D/E/I-W 2M    | difúzor / difúzor   | bílá / biela                        |
|       | 26576 | SHADE CK C/D/E/I-FR   | difúzor / difúzor   | transparentní / transparentný       |
|       | 26577 | SHADE CK C/D/E/I-FR2M | difúzor / difúzor   | transparentní / transparentný       |
|       | 26578 | SHADE CK C/D/E/I-W    | difúzor / difúzor   | bílá / biela                        |
|       | 26579 | SHADE CK C/D/E/I-W 2M | difúzor / difúzor   | bílá / biela                        |
|       | 19184 | STOPPER E             | záslepka / záslepka | šedá / šedá                         |
|       | 26597 | HANDLE C/D/E          | držák / držiak      | nerez / nerez                       |
|       | 26563 | CONNECT C/D/E         | spojka / spojka     | hliník / hliník                     |

PROFILO F - TALL SURFACE ALUMINIUM PROFILE

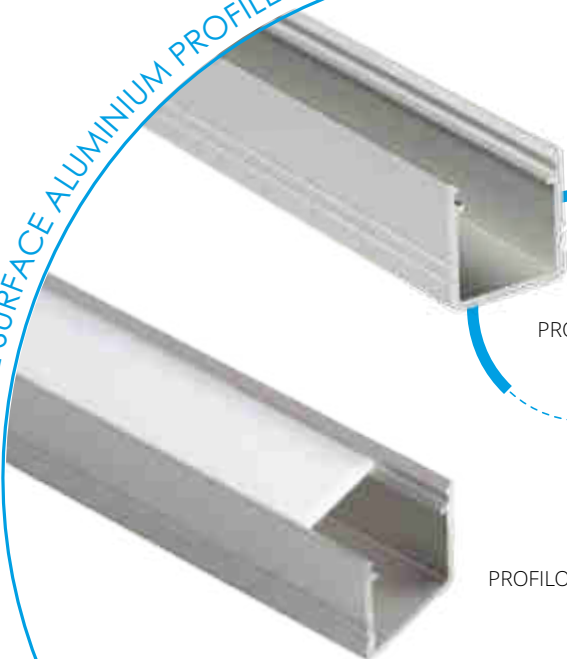

PROFILO F

PROFILO F + SHADE B/F-

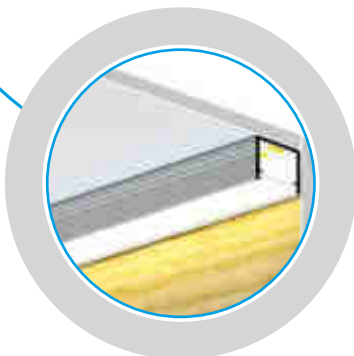
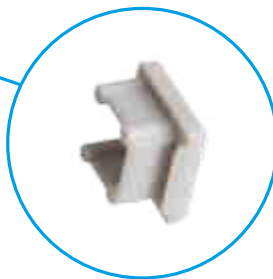

# PROFILO<sub>F</sub>

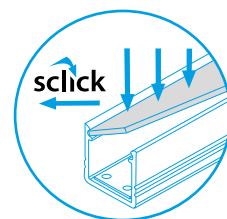
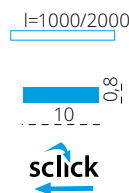
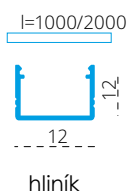

- 📁 **26552** PROFILO F
- 📁 **26553** PROFILO F 2M
- 📁 **26568** SHADE B/F-FR
- 📁 **26570** SHADE B/F-FR 2M
- 📁 **26569** SHADE B/F-W
- 📁 **26571** SHADE B/F-W 2M
- 📁 **26590** STOPPER F
- 📁 **26596** HANDLE B/F

- profil / profil
- profil / profil
- difuzor / difúzor
- difuzor / difúzor
- difuzor / difúzor
- difuzor / difúzor
- záslepka / záslepka
- držák / držiak

- 🌀 eloxovaný hliník / eloxovaný hliník
- 🌀 eloxovaný hliník / eloxovaný hliník
- 🌀 transparentní / transparentný
- 🌀 transparentní / transparentný
- 🌀 bílá / biela
- 🌀 bílá / biela
- 🌀 šedá / šedá
- 🌀 nerez / nerez

PROFILO G - RECESSED FLOOR ALUMINIUM PROFILE



PROFILO G + SHADE CK G



l=1000/2000

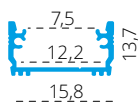

hliník

l=1000/2000



click

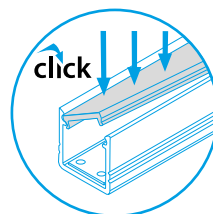

# PROFILO<sub>G</sub>

- }
click
  - 📁 **26558** PROFILO G
  - 📁 **26559** PROFILO G 2M
  - 📁 **26580** SHADE CK G
  - 📁 **26581** SHADE CK G 2M
  - 📁 **26592** STOPPER G
  - 📁 **26598** HANDLE G
  - 📁 **26602** SEALINGS G

- profil / profil
- profil / profil
- difúzor / difúzor
- difúzor / difúzor
- záslepka / záslepka
- držák / držiak
- tesnení / tesnenie

- 🌀 eloxovaný hliník / eloxovaný hliník
- 🌀 eloxovaný hliník / eloxovaný hliník
- 🌀 bílá / biela
- 🌀 bílá / biela
- 🌀 šedá / šedá
- 🌀 nerez / nerez
- 🌀 šedá / šedá

PROFILO H - FLEXIBLE ALUMINIUM PROFILE



PROFILO H + SHADE Ø H-W

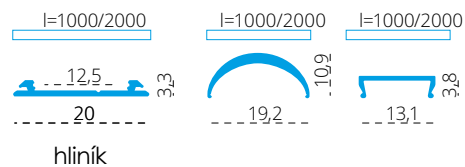
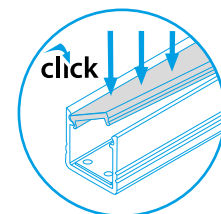

# PROFILO<sub>H</sub>

|       |                              |                     |                                     |
|-------|------------------------------|---------------------|-------------------------------------|
| click | <b>26560</b> PROFILO H       | profil / profil     | eloxovaný hliník / eloxovaný hliník |
|       | <b>26561</b> PROFILO H 2M    | profil / profil     | eloxovaný hliník / eloxovaný hliník |
|       | <b>26582</b> SHADE-U H-FR    | difuzor / difúzor   | transparentní / transparentný       |
|       | <b>26583</b> SHADE-U H-FR 2M | difuzor / difúzor   | transparentní / transparentný       |
|       | <b>26584</b> SHADE-U H-W     | difuzor / difúzor   | bílá / biela                        |
|       | <b>26585</b> SHADE-U H-W 2M  | difuzor / difúzor   | bílá / biela                        |
|       | <b>26586</b> SHADE-O H-W     | difuzor / difúzor   | bílá / biela                        |
|       | <b>26587</b> SHADE-O H-W 2M  | difuzor / difúzor   | bílá / biela                        |
|       | <b>26593</b> STOPPER-U H     | záslepka / záslepka | šedá / šedá                         |
|       | <b>26594</b> STOPPER-O H     | záslepka / záslepka | šedá / šedá                         |
|       | <b>26599</b> HANDLE H        | držák / držiak      | nerez / nerez                       |
|       | <b>26600</b> HANDLE SIDE H   | držák / držiak      | šedá / šedá                         |





PROFILO I - A RECESSED PROFILE WHICH CAN GIVE COUNTINOUS LINE EFFECT

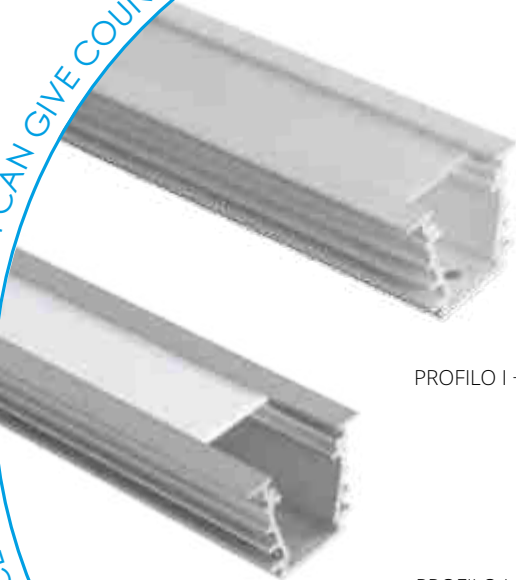

PROFILO I + SHADE c/D/E/I-FR

PROFILO I + SHADE c/D/E/I-W

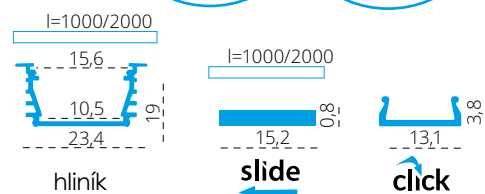
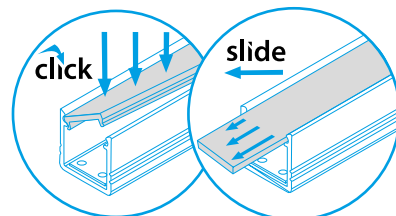
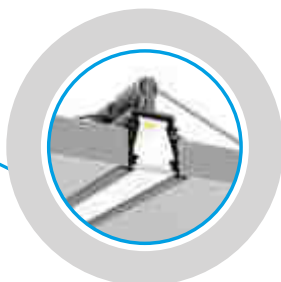
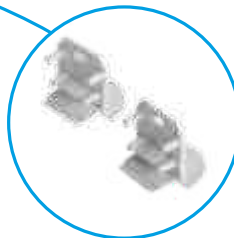

# PROFILO I

|       |       |                       |                              |                                     |
|-------|-------|-----------------------|------------------------------|-------------------------------------|
| slide | 26554 | PROFILO I             | profil / profil              | eloxovaný hliník / eloxovaný hliník |
|       | 26555 | PROFILO I 2M          | profil / profil              | eloxovaný hliník / eloxovaný hliník |
|       | 26556 | PROFILO I-W           | difúzor / difúzor            | bílá / biela                        |
|       | 26557 | PROFILO I-W 2M        | difúzor / difúzor            | bílá / biela                        |
|       | 26572 | SHADE C/D/E/I-FR      | difúzor / difúzor            | transparentní / transparentný       |
|       | 26573 | SHADE C/D/E/I-FR 2M   | difúzor / difúzor            | transparentní / transparentný       |
|       | 26574 | SHADE C/D/E/I-W       | difúzor / difúzor            | bílá / biela                        |
|       | 26575 | SHADE C/D/E/I-W 2M    | difúzor / difúzor            | bílá / biela                        |
|       | 26576 | SHADE CK C/D/E/I-FR   | difúzor / difúzor            | transparentní / transparentný       |
|       | 26577 | SHADE CK C/D/E/I-FR2M | difúzor / difúzor            | transparentní / transparentný       |
| click | 26578 | SHADE CK C/D/E/I-W    | difúzor / difúzor            | bílá / biela                        |
|       | 26579 | SHADE CK C/D/E/I-W 2M | difúzor / difúzor            | bílá / biela                        |
|       | 26591 | STOPPER I             | záslepka / záslepka          | šedá / šedá                         |
|       | 26603 | STOPPER I-W           | záslepka / záslepka          | bílá / biela                        |
|       | 26563 | CONNECT C/D/E/I       | spojka / spojka              | hliník / hliník                     |
|       | 26597 | HANDLE C/D/E/I        | držák / držiak               | nerez / nerez                       |
|       | 26601 | SPRING I              | držák do SDK / držiak do SDK | hliník / hliník                     |

PROFILO J - BASIC SURFACE ALUMINIUM PROFILE

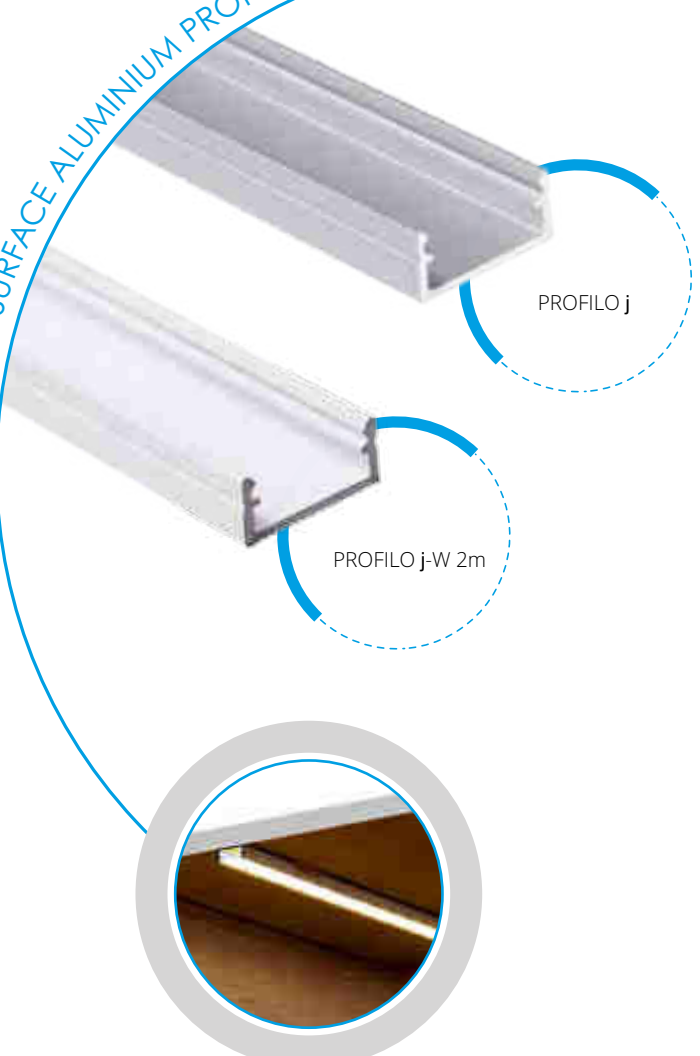

PROFILO j

PROFILO j-W 2m

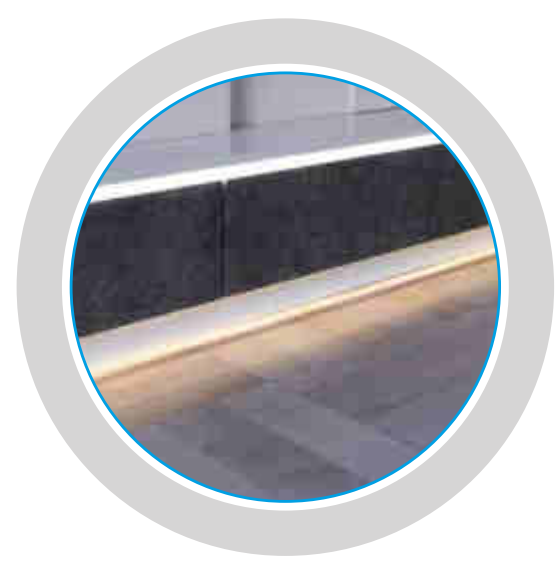
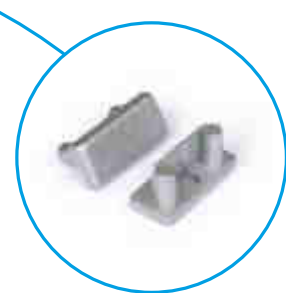

# PROFILO<sub>J</sub>

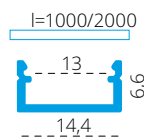

hliník

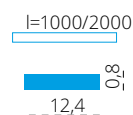

sclick

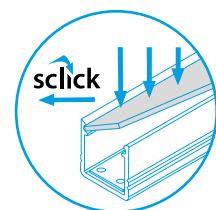

- 📁 26544 PROFILO J
- 📁 26545 PROFILO J 2M
- 📁 26546 PROFILO J-W
- 📁 26547 PROFILO J-W 2M
- 📁 26564 SHADE J/K-FR
- 📁 26566 SHADE J/K-FR 2M
- 📁 26565 SHADE J/K-W
- 📁 26567 SHADE J/K-W 2M
- 📁 26588 STOPPER J
- 📁 26605 STOPPER J-W
- 📁 26595 HANDLE J/K

- profil / profil
- profil / profil
- profil / profil
- profil / profil
- difúzor / difúzor
- difúzor / difúzor
- difúzor / difúzor
- difúzor / difúzor
- záslepka / záslepka
- záslepka / záslepka
- držák / držiak

- 🌀 eloxovaný hliník / eloxovaný hliník
- 🌀 eloxovaný hliník / eloxovaný hliník
- 🌀 bílá / biela
- 🌀 bílá / biela
- 🌀 transparentní / transparentný
- 🌀 transparentní / transparentný
- 🌀 bílá / biela
- 🌀 bílá / biela
- 🌀 šedá / šedá
- 🌀 bílá / biela
- 🌀 nerez / nerez

PROFILO K - SMALL RECESSED ALUMINIUM PROFILE

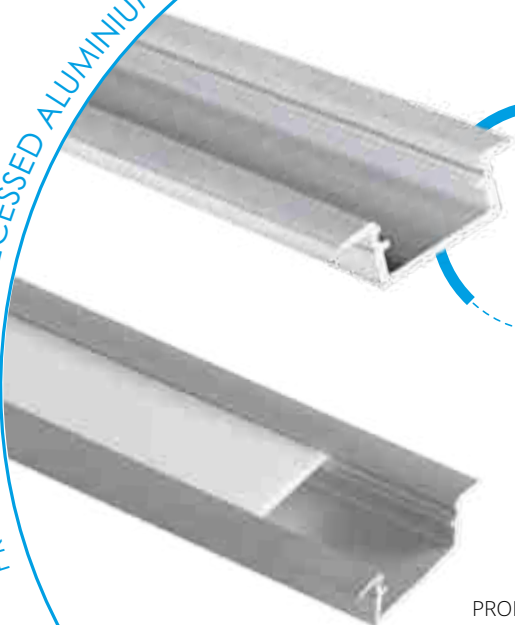

PROFILO K

PROFILO K + SHADE j/K-W

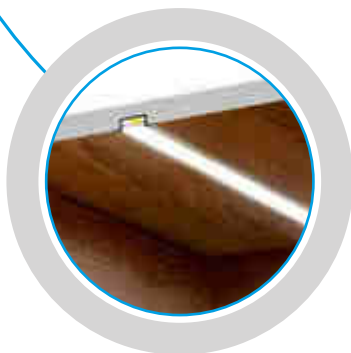
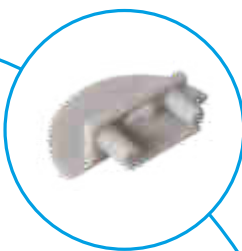

# PROFILO<sub>K</sub>

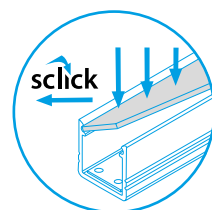
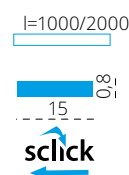
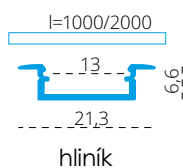

|                              |                     |                                     |
|------------------------------|---------------------|-------------------------------------|
| <b>26548</b> PROFILO K       | profil / profil     | eloxovaný hliník / eloxovaný hliník |
| <b>26549</b> PROFILO K 2M    | profil / profil     | eloxovaný hliník / eloxovaný hliník |
| <b>26550</b> PROFILO K-W     | profil / profil     | bílá / biela                        |
| <b>26551</b> PROFILO K-W 2M  | profil / profil     | bílá / biela                        |
| <b>26564</b> SHADE J/K-FR    | difuzor / difúzor   | transparentní / transparentný       |
| <b>26566</b> SHADE J/K-FR 2M | difuzor / difúzor   | transparentní / transparentný       |
| <b>26565</b> SHADE J/K-W     | difuzor / difúzor   | bílá / biela                        |
| <b>26567</b> SHADE J/K-W 2M  | difuzor / difúzor   | bílá / biela                        |
| <b>26589</b> STOPPER K       | záslepka / záslepka | šedá / šedá                         |
| <b>26606</b> STOPPER K-W     | záslepka / záslepka | bílá / biela                        |
| <b>26595</b> HANDLE J/K      | držák / držiak      | nerez / nerez                       |