





PROFILO_A



-  **19160** PROFILO A
-  **19170** SHADE A-FR
-  **19190** HANDLE A

- profil / profil
- difúzor / difúzor
- držák / držiak

-  eloxovaný hliník / eloxovaný hliník
-  transparentní / transparentný
-  nerez / nerez

PROFILO B - SMALL SURFACE ALUMINIUM PROFILE

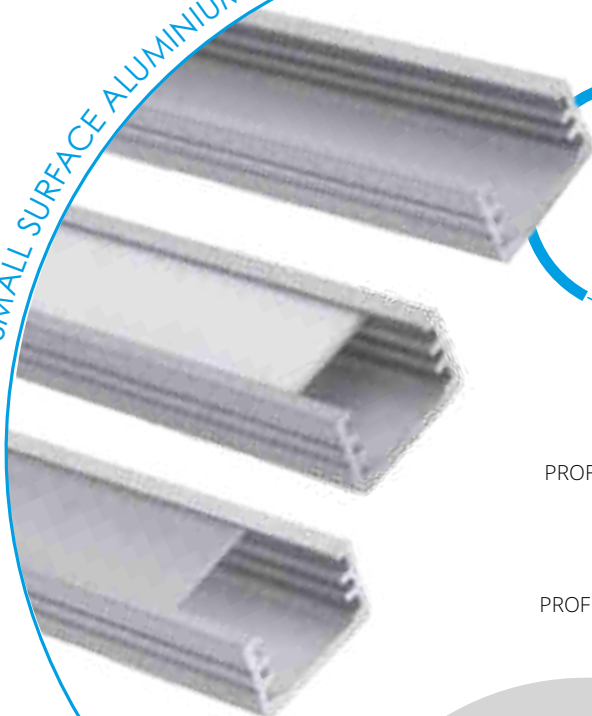

PROFILO B

PROFILO B + SHADE B/F-W

PROFILO B + SHADE B/F-FR

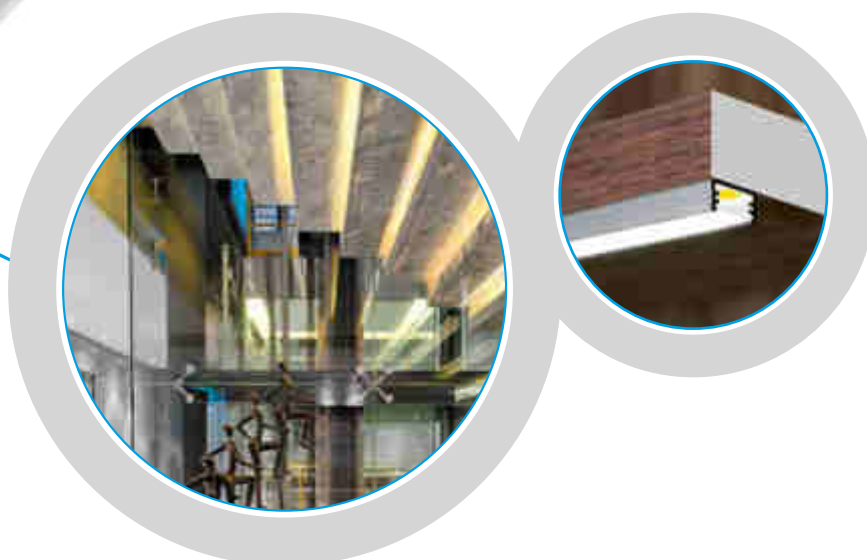
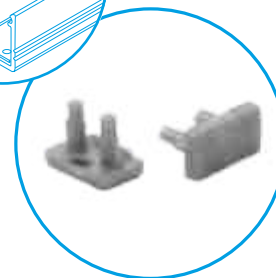
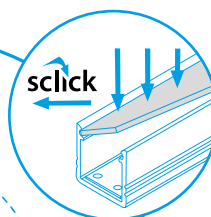

PROFILO_B

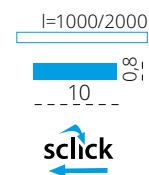
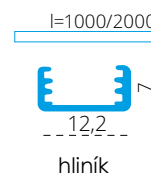

- 📁 19161 PROFILO B
- 📁 26540 PROFILO B 2M
- 📁 26568 SHADE B/F-FR
- 📁 26569 SHADE B/F-W
- 📁 26570 SHADE B/F-FR 2M
- 📁 26571 SHADE B/F-W 2M
- 📁 26596 HANDLE B/F
- 📁 26604 CONNECT-L B
- 📁 19181 STOPPER B

- profil / profil
- profil / profil
- difuzor / difúzor
- difuzor / difúzor
- difuzor / difúzor
- difuzor / difúzor
- držák / držiak
- spojka / spojka
- záslepka / záslepka

- 🌀 eloxovaný hliník / eloxovaný hliník
- 🌀 eloxovaný hliník / eloxovaný hliník
- 🌀 transparentní / transparentný
- 🌀 bílá / biela
- 🌀 transparentní / transparentný
- 🌀 bílá / biela
- 🌀 nerez / nerez
- 🌀 hliník / hliník
- 🌀 šedá / šedá

PROFILO C - CORNER ALUMINIUM PROFILE (ANGULAR 30°, 60°)

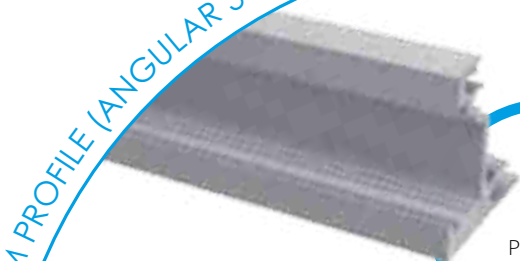

PROFILO c

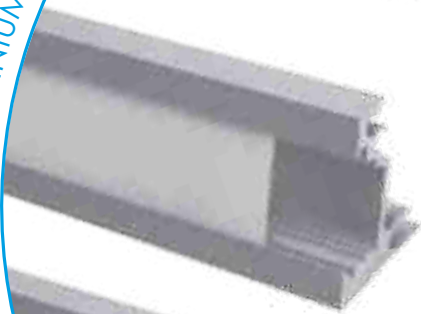

PROFILO c + SHADE c/D/E/I-W

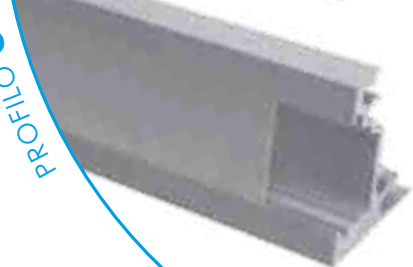

PROFILO c + SHADE c/D/E/I-FR

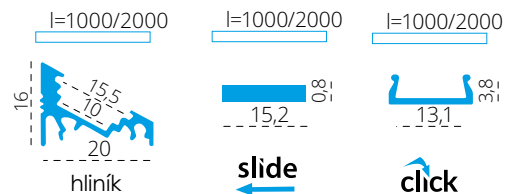
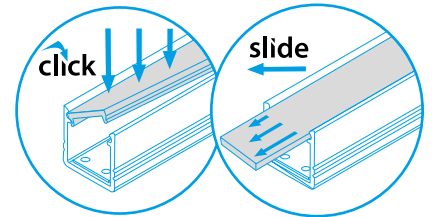
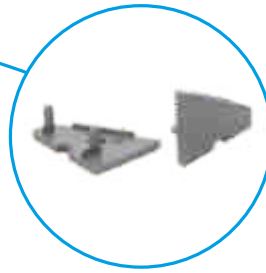

PROFILO_C

slide	19162	PROFILO C	profil / profil	eloxovaný hliník / eloxovaný hliník
	26541	PROFILO C 2M	profil / profil	eloxovaný hliník / eloxovaný hliník
	26572	SHADE C/D/E/I-FR	difuzor / difúzor	transparentní / transparentný
	26573	SHADE C/D/E/I-FR 2M	difuzor / difúzor	transparentní / transparentný
	26574	SHADE C/D/E/I-W	difuzor / difúzor	bílá / biela
	26575	SHADE C/D/E/I-W 2M	difuzor / difúzor	bílá / biela
click	26576	SHADE CK C/D/E/I-FR	difuzor / difúzor	transparentní / transparentný
	26577	SHADE CK C/D/E/I-FR2M	difuzor / difúzor	transparentní / transparentný
	26578	SHADE CK C/D/E/I-W	difuzor / difúzor	bílá / biela
	26579	SHADE CK C/D/E/I-W 2M	difuzor / difúzor	bílá / biela
	19182	STOPPER C	záslepka / záslepka	šedá / šedá
	19191	HANDLE C/D/E	držák / držiak	nerez / nerez
	26562	CONNECT-L C	spojka / spojka	hliník / hliník
	26597	HANDLE C/D/E/I	držák / držiak	hliník / hliník



PROFILO E - ANGULAR 45°

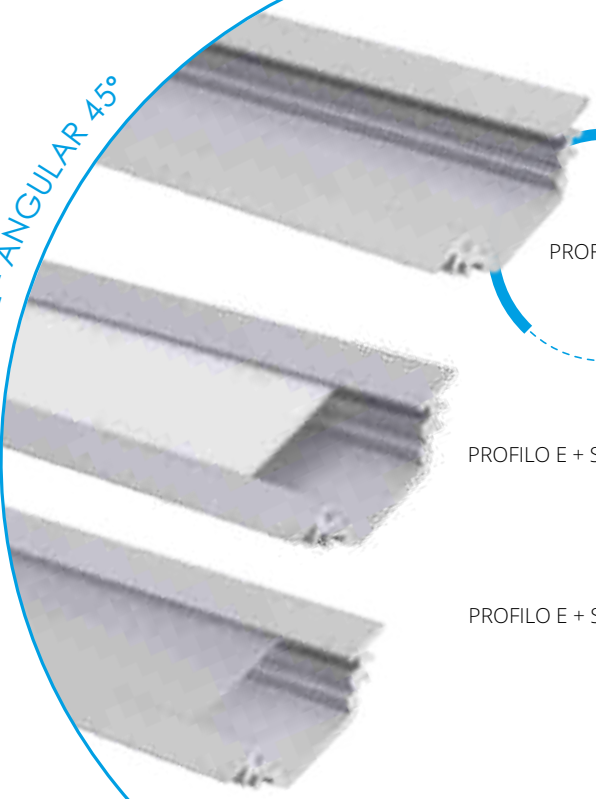

PROFILO E

PROFILO E + SHADE C/D/E/I-W

PROFILO E + SHADE C/D/E/I-FR

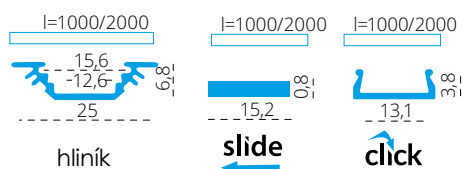
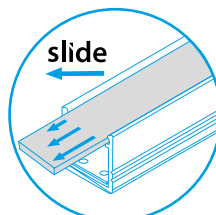
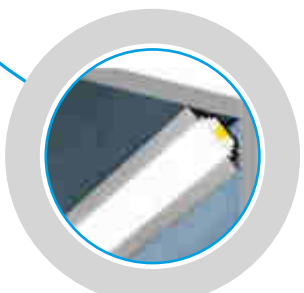

PROFILO_E

slide	19164	PROFILO E	profil / profil	eloxovaný hliník / eloxovaný hliník	
	26543	PROFILO E 2M	profil / profil	eloxovaný hliník / eloxovaný hliník	
	26572	SHADE C/D/E/I-FR	difúzor / difúzor	transparentní / transparentný	
	26573	SHADE C/D/E/I-FR 2M	difúzor / difúzor	transparentní / transparentný	
	26574	SHADE C/D/E/I-W	difúzor / difúzor	bílá / biela	
	26575	SHADE C/D/E/I-W 2M	difúzor / difúzor	bílá / biela	
	click	26576	SHADE CK C/D/E/I-FR	difúzor / difúzor	transparentní / transparentný
		26577	SHADE CK C/D/E/I-FR2M	difúzor / difúzor	transparentní / transparentný
		26578	SHADE CK C/D/E/I-W	difúzor / difúzor	bílá / biela
		26579	SHADE CK C/D/E/I-W 2M	difúzor / difúzor	bílá / biela
	19184	STOPPER E	záslepka / záslepka	šedá / šedá	
	26597	HANDLE C/D/E	držák / držiak	nerez / nerez	
	26563	CONNECT C/D/E	spojka / spojka	hliník / hliník	

PROFILO F - TALL SURFACE ALUMINIUM PROFILE

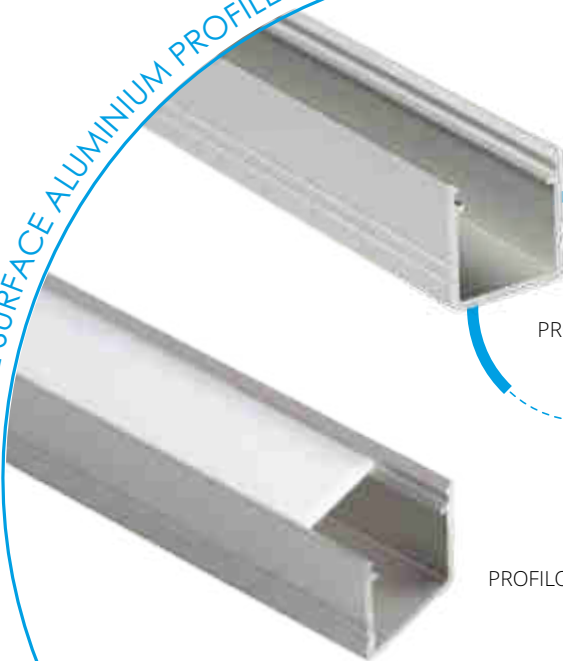

PROFILO F

PROFILO F + SHADE B/F-

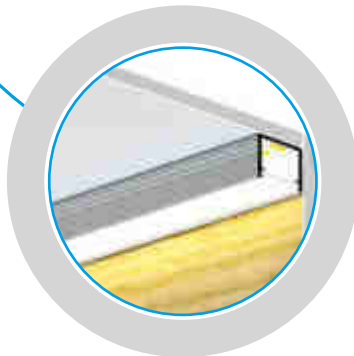

PROFILO_F

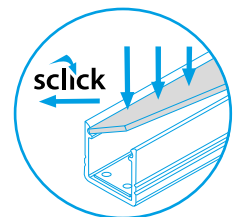
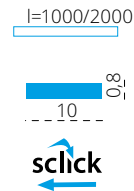
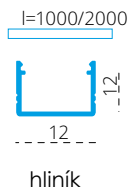

- 📁 **26552** PROFILO F
- 📁 **26553** PROFILO F 2M
- 📁 **26568** SHADE B/F-FR
- 📁 **26570** SHADE B/F-FR 2M
- 📁 **26569** SHADE B/F-W
- 📁 **26571** SHADE B/F-W 2M
- 📁 **26590** STOPPER F
- 📁 **26596** HANDLE B/F

- profil / profil
- profil / profil
- difuzor / difúzor
- difuzor / difúzor
- difuzor / difúzor
- difuzor / difúzor
- záslepka / záslepka
- držák / držiak

- 🌀 eloxovaný hliník / eloxovaný hliník
- 🌀 eloxovaný hliník / eloxovaný hliník
- 🌀 transparentní / transparentný
- 🌀 transparentní / transparentný
- 🌀 bílá / biela
- 🌀 bílá / biela
- 🌀 šedá / šedá
- 🌀 nerez / nerez

PROFILO G - RECESSED FLOOR ALUMINIUM PROFILE



PROFILO G + SHADE CK G



l=1000/2000

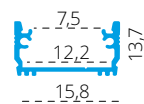

hliník

l=1000/2000

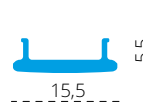

click

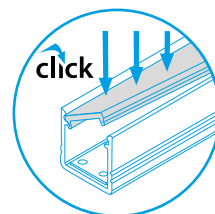

PROFILO_G

- }
click
 - ▢
26558 PROFILO G
 - ▢
26559 PROFILO G 2M
 - ▢
26580 SHADE CK G
 - ▢
26581 SHADE CK G 2M
 - ▢
26592 STOPPER G
 - ▢
26598 HANDLE G
 - ▢
26602 SEALINGS G

- profil / profil
- profil / profil
- difúzor / difúzor
- difúzor / difúzor
- záslepka / záslepka
- držák / držiak
- tesnení / tesnenie

- ⊗
 eloxovaný hliník / eloxovaný hliník
- ⊗
 eloxovaný hliník / eloxovaný hliník
- ⊗
 bílá / biela
- ⊗
 bílá / biela
- ⊗
 šedá / šedá
- ⊗
 nerez / nerez
- ⊗
 šedá / šedá

PROFILO H - FLEXIBLE ALUMINIUM PROFILE



PROFILO H + SHADE Ø H-W

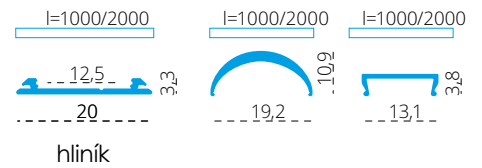
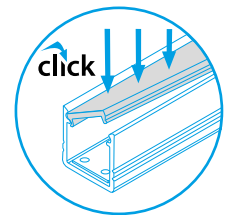

PROFILO_H

click

- 📁 **26560** PROFILO H
- 📁 **26561** PROFILO H 2M
- 📁 **26582** SHADE-U H-FR
- 📁 **26583** SHADE-U H-FR 2M
- 📁 **26584** SHADE-U H-W
- 📁 **26585** SHADE-U H-W 2M
- 📁 **26586** SHADE-O H-W
- 📁 **26587** SHADE-O H-W 2M
- 📁 **26593** STOPPER-U H
- 📁 **26594** STOPPER-O H
- 📁 **26599** HANDLE H
- 📁 **26600** HANDLE SIDE H

- profil / profil
- profil / profil
- difuzor / difúzor
- difuzor / difúzor
- difuzor / difúzor
- difuzor / difúzor
- difuzor / difúzor
- difuzor / difúzor
- záslepka / záslepka
- záslepka / záslepka
- držák / držiak
- držák / držiak

- 🌀 eloxovaný hliník / eloxovaný hliník
- 🌀 eloxovaný hliník / eloxovaný hliník
- 🌀 transparentní / transparentný
- 🌀 transparentní / transparentný
- 🌀 bílá / biela
- 🌀 bílá / biela
- 🌀 bílá / biela
- 🌀 bílá / biela
- 🌀 šedá / šedá
- 🌀 šedá / šedá
- 🌀 nerez / nerez
- 🌀 šedá / šedá



PROFILO I - A RECESSED PROFILE WHICH CAN GIVE COUNTINOUS LINE EFFECT

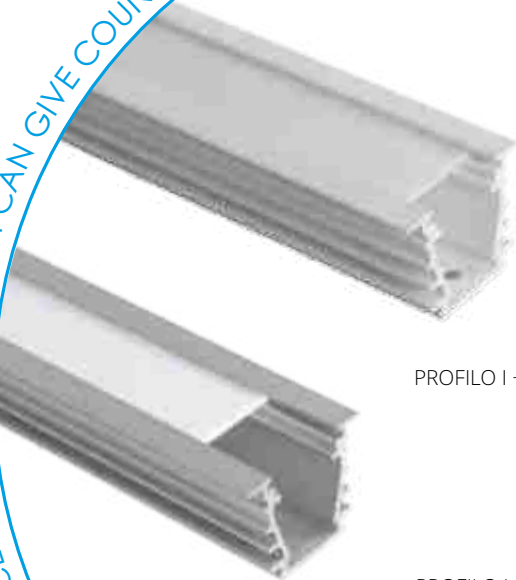

PROFILO I + SHADE c/D/E/I-FR

PROFILO I + SHADE c/D/E/I-W

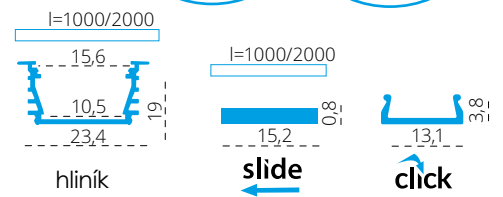
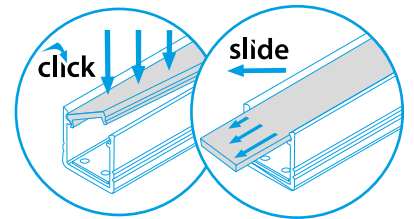
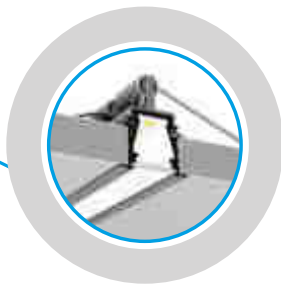
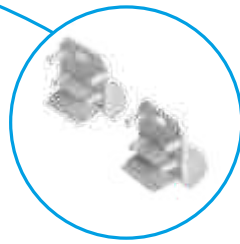

PROFILO I

slide	26554	PROFILO I	profil / profil	eloxovaný hliník / eloxovaný hliník	
	26555	PROFILO I 2M	profil / profil	eloxovaný hliník / eloxovaný hliník	
	26556	PROFILO I-W	difúzor / difúzor	bílá / biela	
	26557	PROFILO I-W 2M	difúzor / difúzor	bílá / biela	
	26572	SHADE C/D/E/I-FR	difúzor / difúzor	transparentní / transparentný	
	26573	SHADE C/D/E/I-FR 2M	difúzor / difúzor	transparentní / transparentný	
	26574	SHADE C/D/E/I-W	difúzor / difúzor	bílá / biela	
	26575	SHADE C/D/E/I-W 2M	difúzor / difúzor	bílá / biela	
	click	26576	SHADE CK C/D/E/I-FR	difúzor / difúzor	transparentní / transparentný
		26577	SHADE CK C/D/E/I-FR2M	difúzor / difúzor	transparentní / transparentný
26578		SHADE CK C/D/E/I-W	difúzor / difúzor	bílá / biela	
26579		SHADE CK C/D/E/I-W 2M	difúzor / difúzor	bílá / biela	
	26591	STOPPER I	záslepka / záslepka	šedá / šedá	
	26603	STOPPER I-W	záslepka / záslepka	bílá / biela	
	26563	CONNECT C/D/E/I	spojka / spojka	hliník / hliník	
	26597	HANDLE C/D/E/I	držák / držiak	nerez / nerez	
	26601	SPRING I	držák do SDK / držiak do SDK	hliník / hliník	

PROFILO J - BASIC SURFACE ALUMINIUM PROFILE



PROFILO j

PROFILO j-W 2m

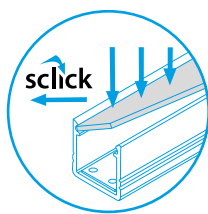
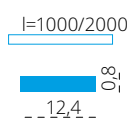
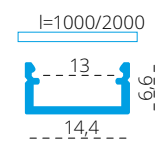

PROFILO_J

hliník

sclick



- 📁 26544 PROFILO J
- 📁 26545 PROFILO J 2M
- 📁 26546 PROFILO J-W
- 📁 26547 PROFILO J-W 2M
- 📁 26564 SHADE J/K-FR
- 📁 26566 SHADE J/K-FR 2M
- 📁 26565 SHADE J/K-W
- 📁 26567 SHADE J/K-W 2M
- 📁 26588 STOPPER J
- 📁 26605 STOPPER J-W
- 📁 26595 HANDLE J/K

profil / profil

profil / profil

profil / profil

profil / profil

difuzor / difúzor

difuzor / difúzor

difuzor / difúzor

difuzor / difúzor

záslepka / záslepka

záslepka / záslepka

držák / držiak

🌀 eloxovaný hliník / eloxovaný hliník

🌀 eloxovaný hliník / eloxovaný hliník

🌀 bílá / biela

🌀 bílá / biela

🌀 transparentní / transparentný

🌀 transparentní / transparentný

🌀 bílá / biela

🌀 bílá / biela

🌀 šedá / šedá

🌀 bílá / biela

🌀 nerez / nerez

PROFILO K - SMALL RECESSED ALUMINIUM PROFILE

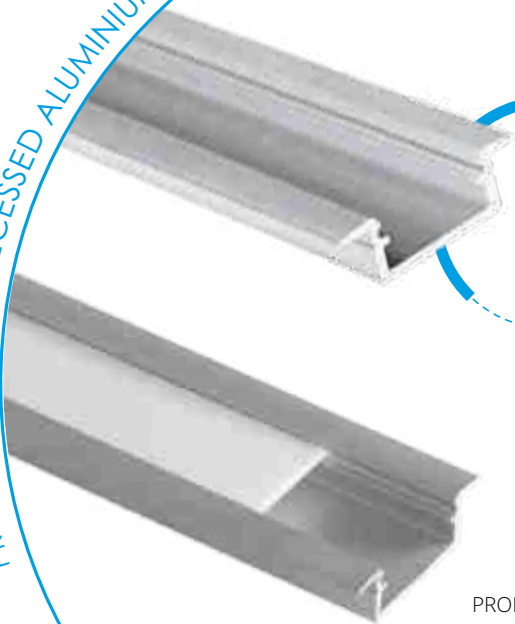

PROFILO K

PROFILO K + SHADE j/K-W

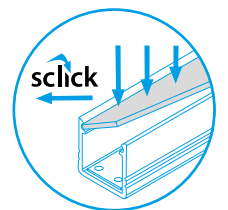
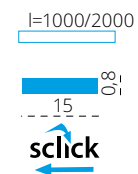
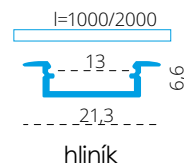
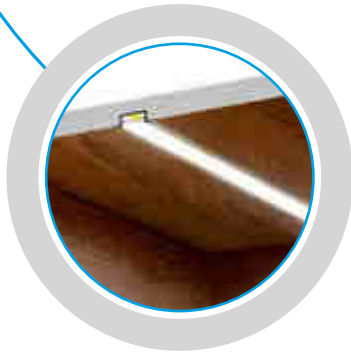
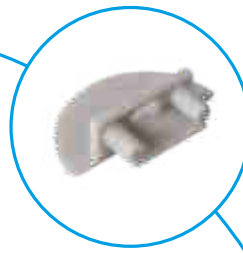

PROFILO_K



- 26548 PROFILO K
- 26549 PROFILO K 2M
- 26550 PROFILO K-W
- 26551 PROFILO K-W 2M
- 26564 SHADE J/K-FR
- 26566 SHADE J/K-FR 2M
- 26565 SHADE J/K-W
- 26567 SHADE J/K-W 2M
- 26589 STOPPER K
- 26606 STOPPER K-W
- 26595 HANDLE J/K

- profil / profil
- profil / profil
- profil / profil
- profil / profil
- difuzor / difúzor
- difuzor / difúzor
- difuzor / difúzor
- difuzor / difúzor
- záslepka / záslepka
- záslepka / záslepka
- držák / držiak

- eloxovaný hliník / eloxovaný hliník
- eloxovaný hliník / eloxovaný hliník
- bílá / biela
- bílá / biela
- transparentní / transparentný
- transparentní / transparentný
- bílá / biela
- bílá / biela
- šedá / šedá
- bílá / biela
- nerez / nerez