



PROFILO_A



- 📁 **19160** PROFILO A
- 📁 **19170** SHADE A-FR
- 📁 **19190** HANDLE A

- profil / profil
- difúzor / difúzor
- držák / držiak

- 🌀 eloxovaný hliník / eloxovaný hliník
- 🌀 transparentní / transparentný
- 🌀 nerez / nerez

PROFILO B - SMALL SURFACE ALUMINIUM PROFILE

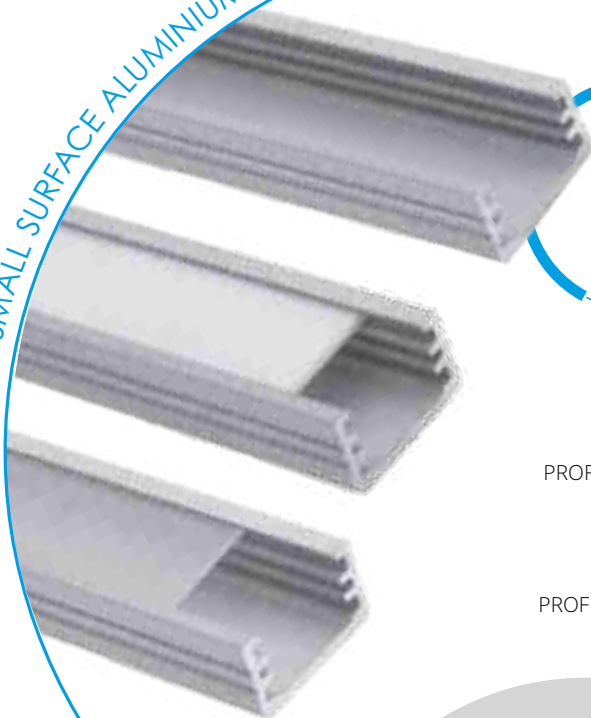

PROFILO B

PROFILO B + SHADE B/F-W

PROFILO B + SHADE B/F-FR

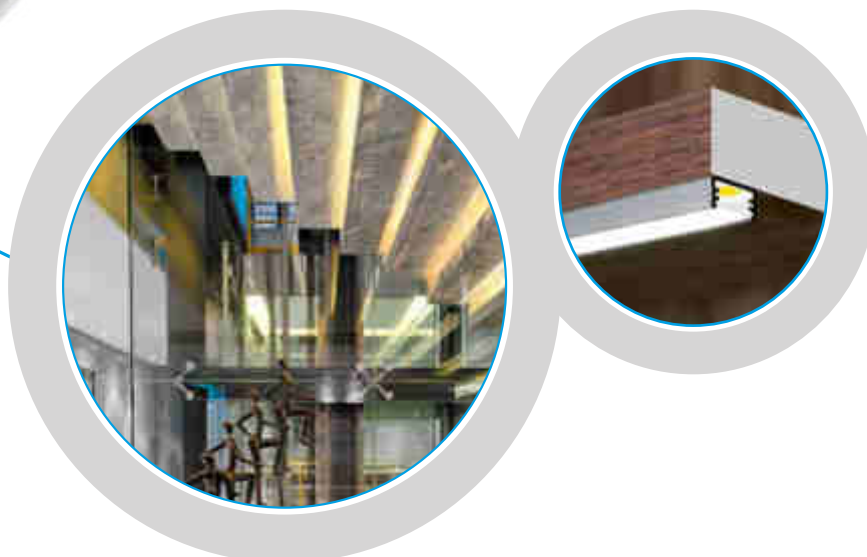
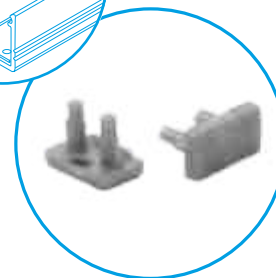
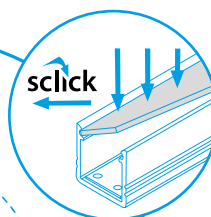

PROFILO_B

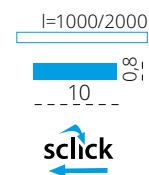
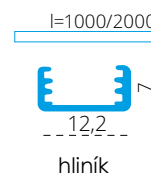

- 📁 19161 PROFILO B
- 📁 26540 PROFILO B 2M
- 📁 26568 SHADE B/F-FR
- 📁 26569 SHADE B/F-W
- 📁 26570 SHADE B/F-FR 2M
- 📁 26571 SHADE B/F-W 2M
- 📁 26596 HANDLE B/F
- 📁 26604 CONNECT-L B
- 📁 19181 STOPPER B

- profil / profil
- profil / profil
- difuzor / difúzor
- difuzor / difúzor
- difuzor / difúzor
- difuzor / difúzor
- držák / držiak
- spojka / spojka
- záslepka / záslepka

- 🌀 eloxovaný hliník / eloxovaný hliník
- 🌀 eloxovaný hliník / eloxovaný hliník
- 🌀 transparentní / transparentný
- 🌀 bílá / biela
- 🌀 transparentní / transparentný
- 🌀 bílá / biela
- 🌀 nerez / nerez
- 🌀 hliník / hliník
- 🌀 šedá / šedá

PROFILO C - CORNER ALUMINIUM PROFILE (ANGULAR 30°, 60°)

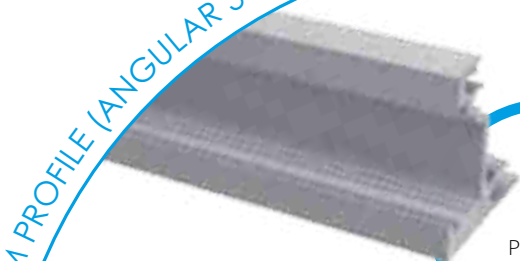

PROFILO c

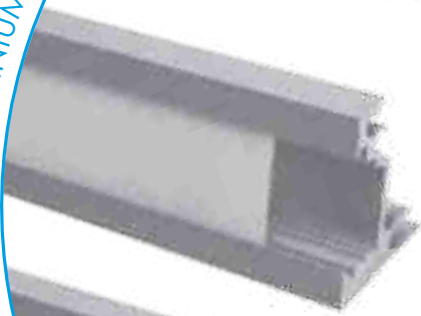

PROFILO c + SHADE c/D/E/I-W

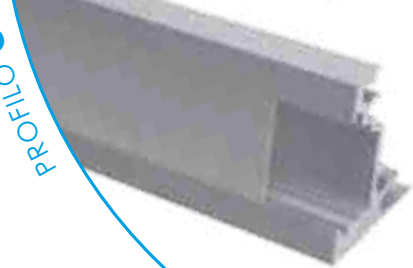

PROFILO c + SHADE c/D/E/I-FR

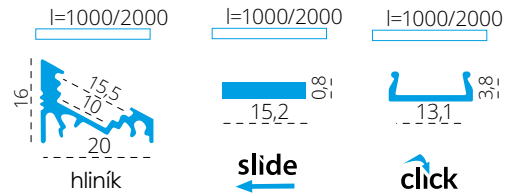
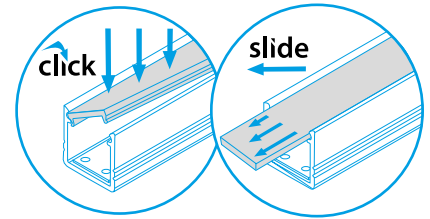
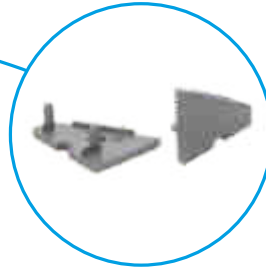

PROFILO_C

| | | | | |
|-------|-------|-----------------------|---------------------|-------------------------------------|
| slide | 19162 | PROFILO C | profil / profil | eloxovaný hliník / eloxovaný hliník |
| | 26541 | PROFILO C 2M | profil / profil | eloxovaný hliník / eloxovaný hliník |
| | 26572 | SHADE C/D/E/I-FR | difuzor / difúzor | transparentní / transparentný |
| | 26573 | SHADE C/D/E/I-FR 2M | difuzor / difúzor | transparentní / transparentný |
| | 26574 | SHADE C/D/E/I-W | difuzor / difúzor | bílá / biela |
| click | 26575 | SHADE C/D/E/I-W 2M | difuzor / difúzor | bílá / biela |
| | 26576 | SHADE CK C/D/E/I-FR | difuzor / difúzor | transparentní / transparentný |
| | 26577 | SHADE CK C/D/E/I-FR2M | difuzor / difúzor | transparentní / transparentný |
| | 26578 | SHADE CK C/D/E/I-W | difuzor / difúzor | bílá / biela |
| | 26579 | SHADE CK C/D/E/I-W 2M | difuzor / difúzor | bílá / biela |
| | 19182 | STOPPER C | záslepka / záslepka | šedá / šedá |
| | 19191 | HANDLE C/D/E | držák / držiak | nerez / nerez |
| | 26562 | CONNECT-L C | spojka / spojka | hliník / hliník |
| | 26597 | HANDLE C/D/E/I | držák / držiak | hliník / hliník |



PROFILO E - ANGULAR 45°

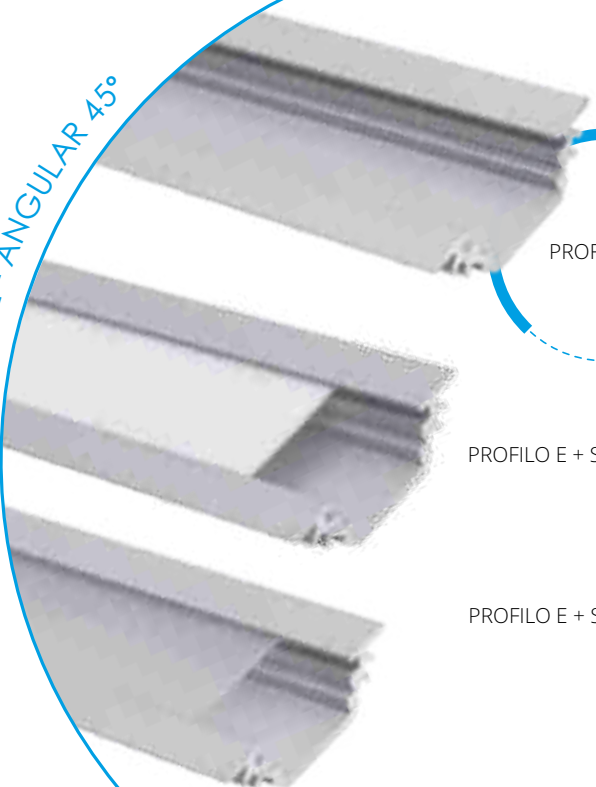

PROFILO E

PROFILO E + SHADE C/D/E/I-W

PROFILO E + SHADE C/D/E/I-FR

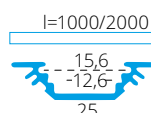
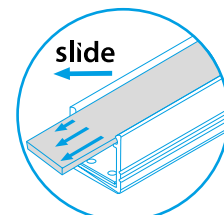
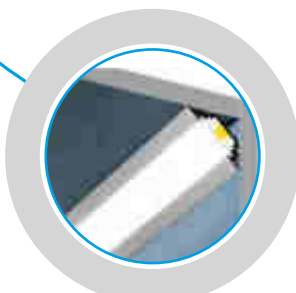

hliník

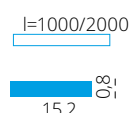

slide

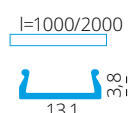

click

PROFILO_E

| | | | | |
|-------|-------|-----------------------|---------------------|-------------------------------------|
| slide | 19164 | PROFILO E | profil / profil | eloxovaný hliník / eloxovaný hliník |
| | 26543 | PROFILO E 2M | profil / profil | eloxovaný hliník / eloxovaný hliník |
| | 26572 | SHADE C/D/E/I-FR | difúzor / difúzor | transparentní / transparentný |
| | 26573 | SHADE C/D/E/I-FR 2M | difúzor / difúzor | transparentní / transparentný |
| | 26574 | SHADE C/D/E/I-W | difúzor / difúzor | bílá / biela |
| click | 26575 | SHADE C/D/E/I-W 2M | difúzor / difúzor | bílá / biela |
| | 26576 | SHADE CK C/D/E/I-FR | difúzor / difúzor | transparentní / transparentný |
| | 26577 | SHADE CK C/D/E/I-FR2M | difúzor / difúzor | transparentní / transparentný |
| | 26578 | SHADE CK C/D/E/I-W | difúzor / difúzor | bílá / biela |
| | 26579 | SHADE CK C/D/E/I-W 2M | difúzor / difúzor | bílá / biela |
| | 19184 | STOPPER E | záslepka / záslepka | šedá / šedá |
| | 26597 | HANDLE C/D/E | držák / držiak | nerez / nerez |
| | 26563 | CONNECT C/D/E | spojka / spojka | hliník / hliník |

PROFILO F - TALL SURFACE ALUMINIUM PROFILE



PROFILO F

PROFILO F + SHADE B/F-W

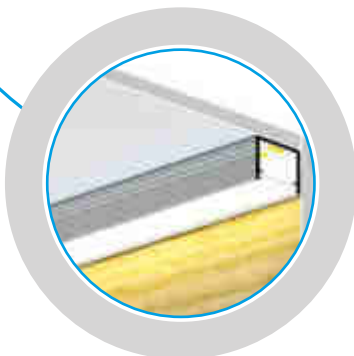
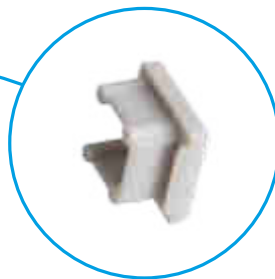

PROFILO_F

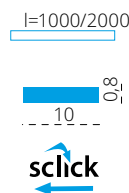
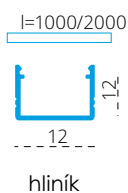

- 📁 26552 PROFILO F
- 📁 26553 PROFILO F 2M
- 📁 26568 SHADE B/F-FR
- 📁 26570 SHADE B/F-FR 2M
- 📁 26569 SHADE B/F-W
- 📁 26571 SHADE B/F-W 2M
- 📁 26590 STOPPER F
- 📁 26596 HANDLE B/F

- profil / profil
- profil / profil
- difuzor / difúzor
- difuzor / difúzor
- difuzor / difúzor
- difuzor / difúzor
- záslepka / záslepka
- držák / držiak

- 🌀 eloxovaný hliník / eloxovaný hliník
- 🌀 eloxovaný hliník / eloxovaný hliník
- 🌀 transparentní / transparentný
- 🌀 transparentní / transparentný
- 🌀 bílá / biela
- 🌀 bílá / biela
- 🌀 šedá / šedá
- 🌀 nerez / nerez

PROFILO G - RECESSED FLOOR ALUMINIUM PROFILE



PROFILO G + SHADE CK G



l=1000/2000

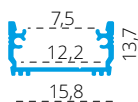

hliník

l=1000/2000



click

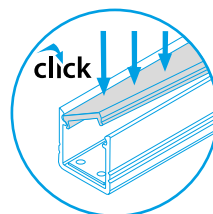

PROFILO_G

- 📁 26558 PROFILO G
- 📁 26559 PROFILO G 2M
- click {
 - 📁 26580 SHADE CK G
 - 📁 26581 SHADE CK G 2M
 - 📁 26592 STOPPER G
 - 📁 26598 HANDLE G
 - 📁 26602 SEALINGS G

- profil / profil
- profil / profil
- difúzor / difúzor
- difúzor / difúzor
- záslepka / záslepka
- držák / držiak
- tesnení / tesnenie

- 🌀 eloxovaný hliník / eloxovaný hliník
- 🌀 eloxovaný hliník / eloxovaný hliník
- 🌀 bílá / biela
- 🌀 bílá / biela
- 🌀 šedá / šedá
- 🌀 nerez / nerez
- 🌀 šedá / šedá

PROFILO H - FLEXIBLE ALUMINIUM PROFILE

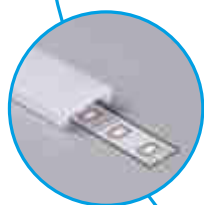

PROFILO H + SHADE Ø H-W

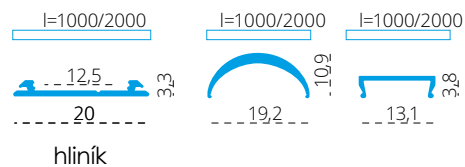
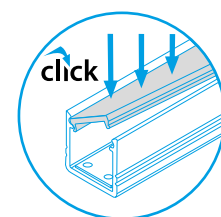

PROFILO_H

| | | | |
|-------|------------------------------|---------------------|-------------------------------------|
| click | 26560 PROFILO H | profil / profil | eloxovaný hliník / eloxovaný hliník |
| | 26561 PROFILO H 2M | profil / profil | eloxovaný hliník / eloxovaný hliník |
| | 26582 SHADE-U H-FR | difuzor / difúzor | transparentní / transparentný |
| | 26583 SHADE-U H-FR 2M | difuzor / difúzor | transparentní / transparentný |
| | 26584 SHADE-U H-W | difuzor / difúzor | bílá / biela |
| | 26585 SHADE-U H-W 2M | difuzor / difúzor | bílá / biela |
| | 26586 SHADE-O H-W | difuzor / difúzor | bílá / biela |
| | 26587 SHADE-O H-W 2M | difuzor / difúzor | bílá / biela |
| | 26593 STOPPER-U H | záslepka / záslepka | šedá / šedá |
| | 26594 STOPPER-O H | záslepka / záslepka | šedá / šedá |
| | 26599 HANDLE H | držák / držiak | nerez / nerez |
| | 26600 HANDLE SIDE H | držák / držiak | šedá / šedá |



PROFILO I - A RECESSED PROFILE WHICH CAN GIVE COUNTINOUS LINE EFFECT

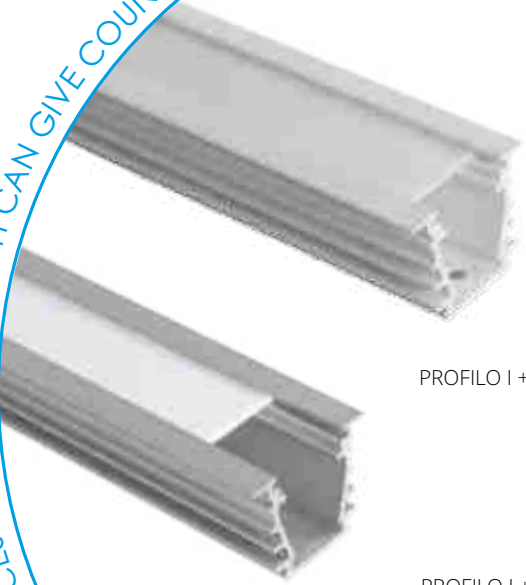

PROFILO I + SHADE c/D/E/I-FR

PROFILO I + SHADE c/D/E/I-W

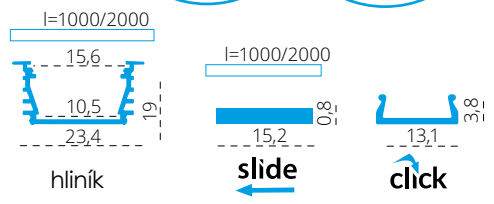
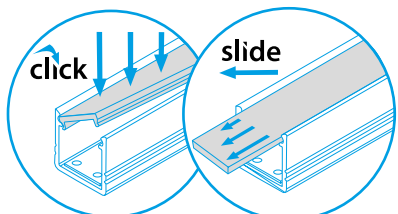
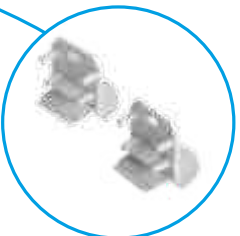

PROFILO I

| | | | | | |
|-------|-------|-----------------------|------------------------------|-------------------------------------|-------------------------------|
| slide | 26554 | PROFILO I | profil / profil | eloxovaný hliník / eloxovaný hliník | |
| | 26555 | PROFILO I 2M | profil / profil | eloxovaný hliník / eloxovaný hliník | |
| | 26556 | PROFILO I-W | difúzor / difúzor | bílá / biela | |
| | 26557 | PROFILO I-W 2M | difúzor / difúzor | bílá / biela | |
| | 26572 | SHADE C/D/E/I-FR | difúzor / difúzor | transparentní / transparentný | |
| | 26573 | SHADE C/D/E/I-FR 2M | difúzor / difúzor | transparentní / transparentný | |
| | 26574 | SHADE C/D/E/I-W | difúzor / difúzor | bílá / biela | |
| | 26575 | SHADE C/D/E/I-W 2M | difúzor / difúzor | bílá / biela | |
| | click | 26576 | SHADE CK C/D/E/I-FR | difúzor / difúzor | transparentní / transparentný |
| | | 26577 | SHADE CK C/D/E/I-FR2M | difúzor / difúzor | transparentní / transparentný |
| 26578 | | SHADE CK C/D/E/I-W | difúzor / difúzor | bílá / biela | |
| 26579 | | SHADE CK C/D/E/I-W 2M | difúzor / difúzor | bílá / biela | |
| | 26591 | STOPPER I | záslepka / záslepka | šedá / šedá | |
| | 26603 | STOPPER I-W | záslepka / záslepka | bílá / biela | |
| | 26563 | CONNECT C/D/E/I | spojka / spojka | hliník / hliník | |
| | 26597 | HANDLE C/D/E/I | držák / držiak | nerez / nerez | |
| | 26601 | SPRING I | držák do SDK / držiak do SDK | hliník / hliník | |

PROFILO J - BASIC SURFACE ALUMINIUM PROFILE



PROFILO j

PROFILO j-W 2m



PROFILO_J

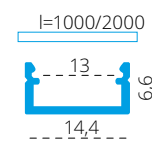

hliník

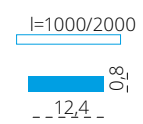

sclick

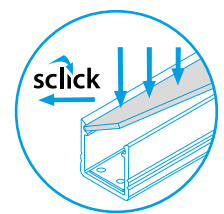

- 📁 26544 PROFILO J
- 📁 26545 PROFILO J 2M
- 📁 26546 PROFILO J-W
- 📁 26547 PROFILO J-W 2M
- 📁 26564 SHADE J/K-FR
- 📁 26566 SHADE J/K-FR 2M
- 📁 26565 SHADE J/K-W
- 📁 26567 SHADE J/K-W 2M
- 📁 26588 STOPPER J
- 📁 26605 STOPPER J-W
- 📁 26595 HANDLE J/K

profil / profil

profil / profil

profil / profil

profil / profil

difuzor / difúzor

difuzor / difúzor

difuzor / difúzor

difuzor / difúzor

záslepka / záslepka

záslepka / záslepka

držák / držiak

🌀 eloxovaný hliník / eloxovaný hliník

🌀 eloxovaný hliník / eloxovaný hliník

🌀 bílá / biela

🌀 bílá / biela

🌀 transparentní / transparentný

🌀 transparentní / transparentný

🌀 bílá / biela

🌀 bílá / biela

🌀 šedá / šedá

🌀 bílá / biela

🌀 nerez / nerez

PROFILO K - SMALL RECESSED ALUMINIUM PROFILE

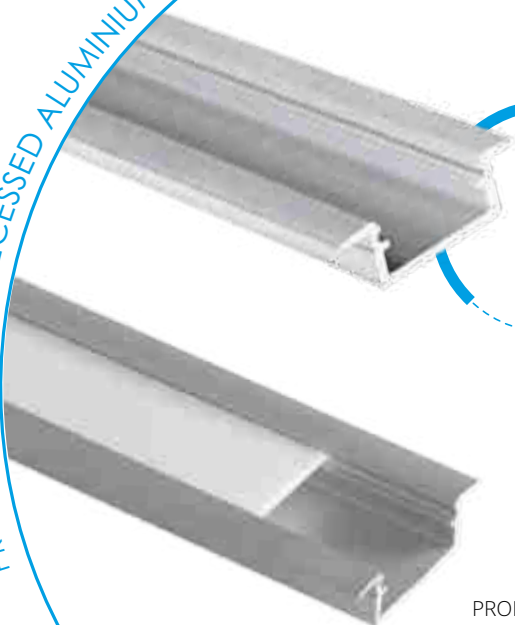

PROFILO K

PROFILO K + SHADE j/K-W

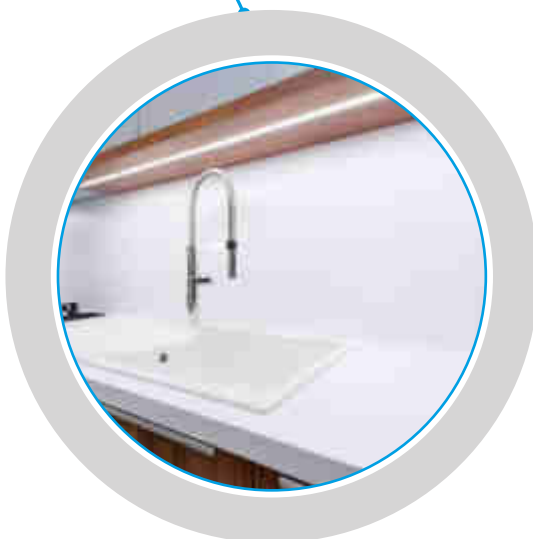
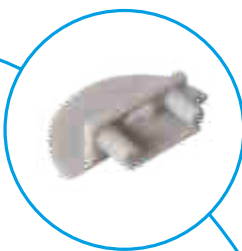

PROFILO_K

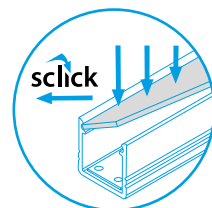
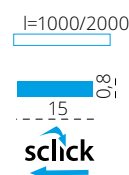
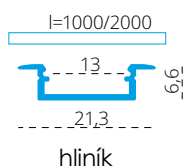

- 📁 **26548** PROFILO K
- 📁 **26549** PROFILO K 2M
- 📁 **26550** PROFILO K-W
- 📁 **26551** PROFILO K-W 2M
- 📁 **26564** SHADE J/K-FR
- 📁 **26566** SHADE J/K-FR 2M
- 📁 **26565** SHADE J/K-W
- 📁 **26567** SHADE J/K-W 2M
- 📁 **26589** STOPPER K
- 📁 **26606** STOPPER K-W
- 📁 **26595** HANDLE J/K

- profil / profil
- profil / profil
- profil / profil
- profil / profil
- difuzor / difúzor
- difuzor / difúzor
- difuzor / difúzor
- difuzor / difúzor
- záslepka / záslepka
- záslepka / záslepka
- držák / držiak

- 🌀 eloxovaný hliník / eloxovaný hliník
- 🌀 eloxovaný hliník / eloxovaný hliník
- 🌀 bílá / biela
- 🌀 bílá / biela
- 🌀 transparentní / transparentný
- 🌀 transparentní / transparentný
- 🌀 bílá / biela
- 🌀 bílá / biela
- 🌀 šedá / šedá
- 🌀 bílá / biela
- 🌀 nerez / nerez