

# PROFILO<sub>A</sub>



- 📁 19160 PROFILO A
- 📁 19170 SHADE A-FR
- 📁 19190 HANDLE A

- profil / profil
- difúzor / difúzor
- držák / držiak

- 🔩 eloxovaný hliník / eloxovaný hliník
- 🔩 transparentní / transparentný
- 🔩 nerez / nerez

PROFILO B - SMALL SURFACE ALUMINIUM PROFILE

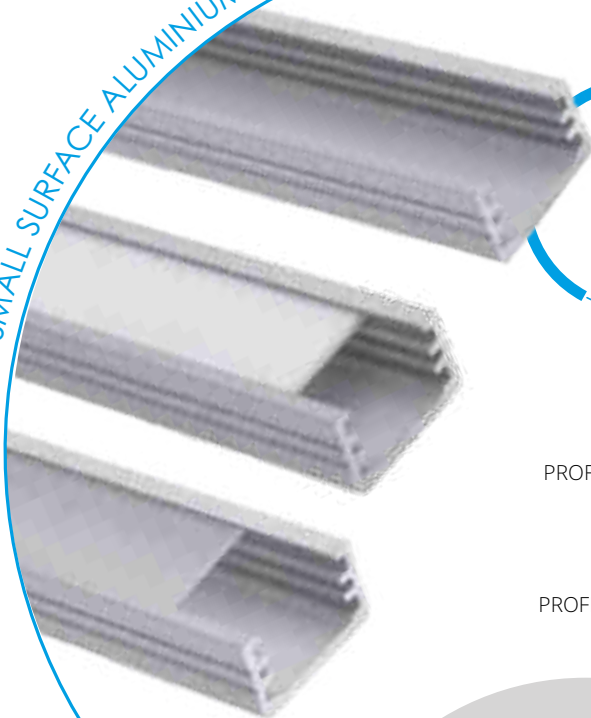

PROFILO B

PROFILO B + SHADE B/F-W

PROFILO B + SHADE B/F-FR

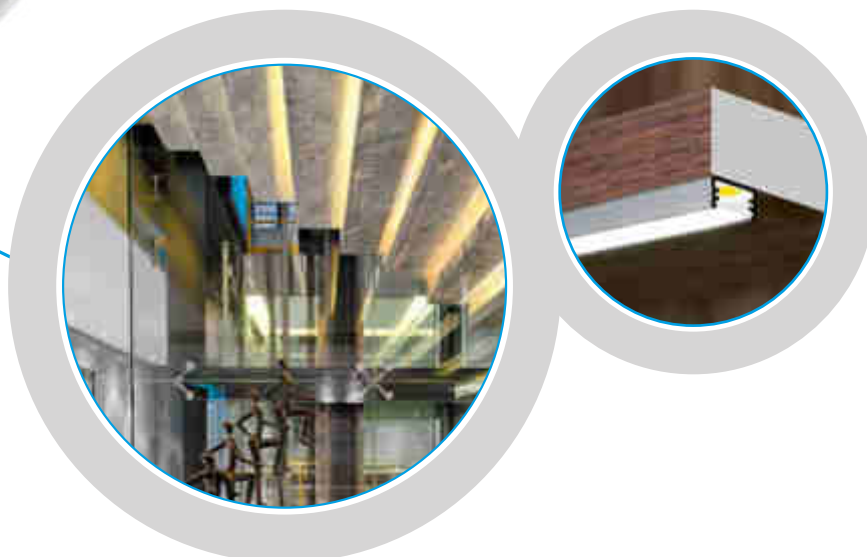
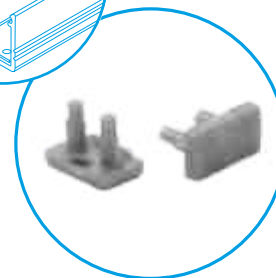
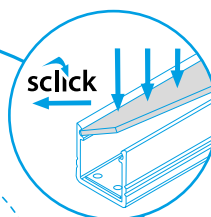

# PROFILO<sub>B</sub>

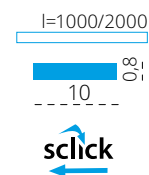
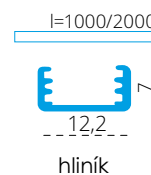

- 📁 19161 PROFILO B
- 📁 26540 PROFILO B 2M
- 📁 26568 SHADE B/F-FR
- 📁 26569 SHADE B/F-W
- 📁 26570 SHADE B/F-FR 2M
- 📁 26571 SHADE B/F-W 2M
- 📁 26596 HANDLE B/F
- 📁 26604 CONNECT-L B
- 📁 19181 STOPPER B

- profil / profil
- profil / profil
- difuzor / difúzor
- difuzor / difúzor
- difuzor / difúzor
- difuzor / difúzor
- držák / držiak
- spojka / spojka
- záslepka / záslepka

- 🌀 eloxovaný hliník / eloxovaný hliník
- 🌀 eloxovaný hliník / eloxovaný hliník
- 🌀 transparentní / transparentný
- 🌀 bílá / biela
- 🌀 transparentní / transparentný
- 🌀 bílá / biela
- 🌀 nerez / nerez
- 🌀 hliník / hliník
- 🌀 šedá / šedá

PROFILO C - CORNER ALUMINIUM PROFILE (ANGULAR 30°, 60°)

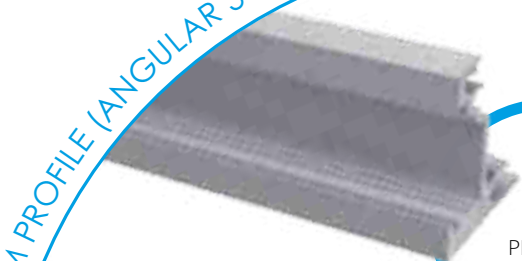

PROFILO c

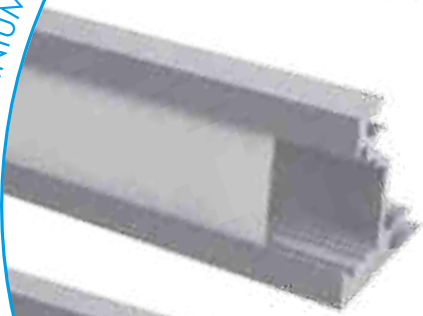

PROFILO c + SHADE c/D/E/I-W

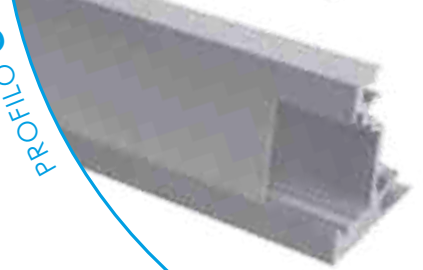

PROFILO c + SHADE c/D/E/I-FR

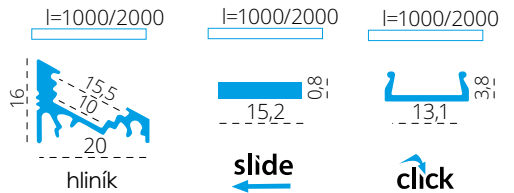
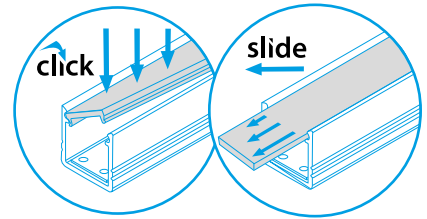
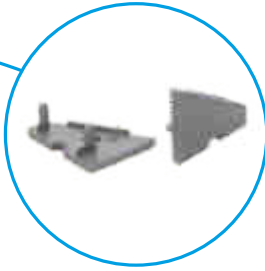

# PROFILO<sub>C</sub>

slide	19162	PROFILO C	profil / profil	eloxovaný hliník / eloxovaný hliník
	26541	PROFILO C 2M	profil / profil	eloxovaný hliník / eloxovaný hliník
	26572	SHADE C/D/E/I-FR	difuzor / difúzor	transparentní / transparentný
	26573	SHADE C/D/E/I-FR 2M	difuzor / difúzor	transparentní / transparentný
	26574	SHADE C/D/E/I-W	difuzor / difúzor	bílá / biela
click	26575	SHADE C/D/E/I-W 2M	difuzor / difúzor	bílá / biela
	26576	SHADE CK C/D/E/I-FR	difuzor / difúzor	transparentní / transparentný
	26577	SHADE CK C/D/E/I-FR2M	difuzor / difúzor	transparentní / transparentný
	26578	SHADE CK C/D/E/I-W	difuzor / difúzor	bílá / biela
	26579	SHADE CK C/D/E/I-W 2M	difuzor / difúzor	bílá / biela
	19182	STOPPER C	záslepka / záslepka	šedá / šedá
	19191	HANDLE C/D/E	držák / držiak	nerez / nerez
	26562	CONNECT-L C	spojka / spojka	hliník / hliník
	26597	HANDLE C/D/E/I	držák / držiak	hliník / hliník





PROFILO E - ANGULAR 45°

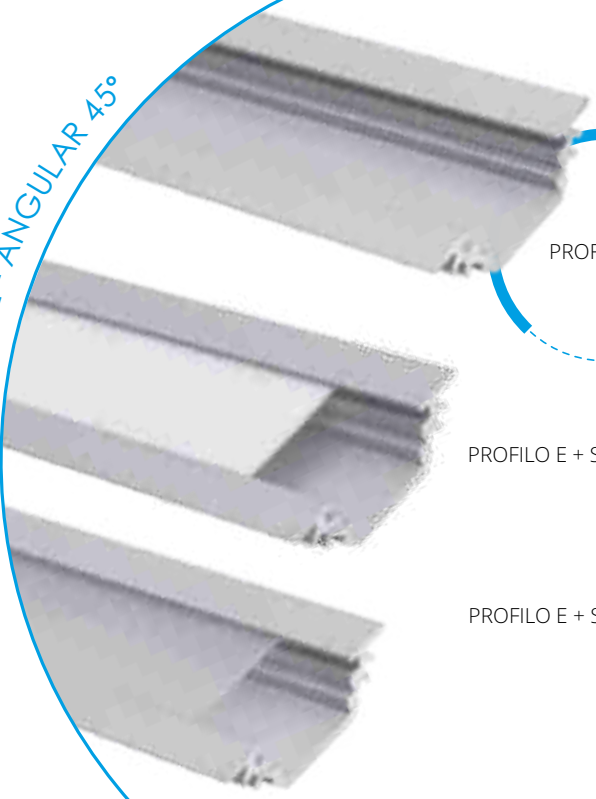

PROFILO E

PROFILO E + SHADE C/D/E/I-W

PROFILO E + SHADE C/D/E/I-FR

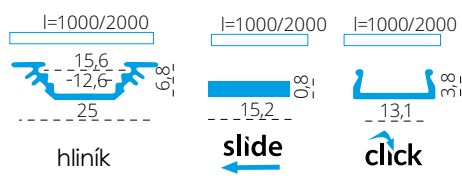
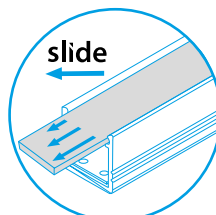
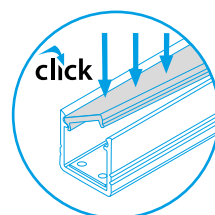
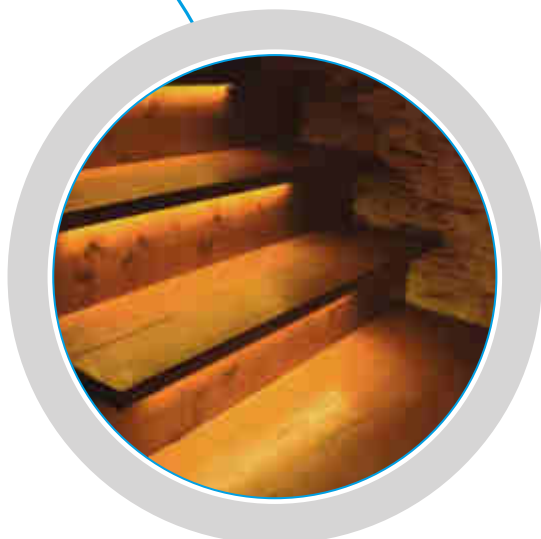

# PROFILO<sub>E</sub>

slide	19164	PROFILO E	profil / profil	eloxovaný hliník / eloxovaný hliník	
	26543	PROFILO E 2M	profil / profil	eloxovaný hliník / eloxovaný hliník	
	26572	SHADE C/D/E/I-FR	difúzor / difúzor	transparentní / transparentný	
	26573	SHADE C/D/E/I-FR 2M	difúzor / difúzor	transparentní / transparentný	
	26574	SHADE C/D/E/I-W	difúzor / difúzor	bílá / biela	
	26575	SHADE C/D/E/I-W 2M	difúzor / difúzor	bílá / biela	
	click	26576	SHADE CK C/D/E/I-FR	difúzor / difúzor	transparentní / transparentný
		26577	SHADE CK C/D/E/I-FR2M	difúzor / difúzor	transparentní / transparentný
		26578	SHADE CK C/D/E/I-W	difúzor / difúzor	bílá / biela
		26579	SHADE CK C/D/E/I-W 2M	difúzor / difúzor	bílá / biela
	19184	STOPPER E	záslepka / záslepka	šedá / šedá	
	26597	HANDLE C/D/E	držák / držiak	nerez / nerez	
	26563	CONNECT C/D/E	spojka / spojka	hliník / hliník	

PROFILO F - TALL SURFACE ALUMINIUM PROFILE

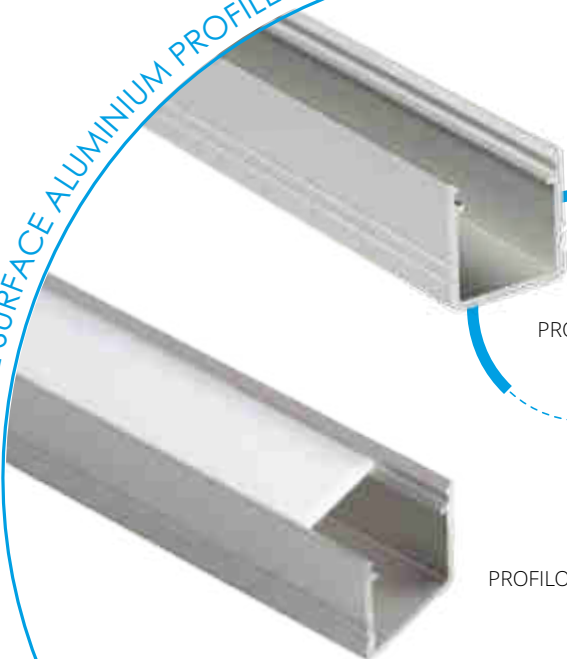

PROFILO F

PROFILO F + SHADE B/F-

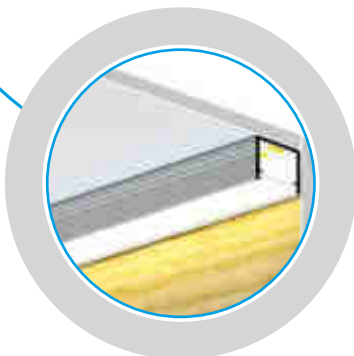
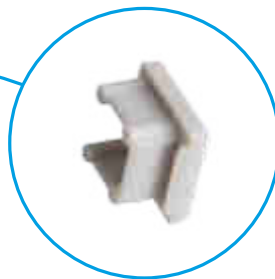

# PROFILO<sub>F</sub>

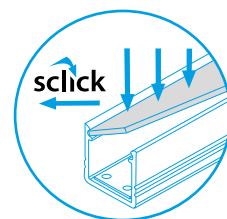
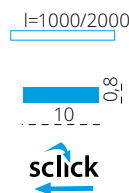
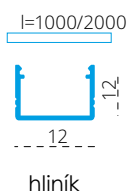

- 📁 **26552** PROFILO F
- 📁 **26553** PROFILO F 2M
- 📁 **26568** SHADE B/F-FR
- 📁 **26570** SHADE B/F-FR 2M
- 📁 **26569** SHADE B/F-W
- 📁 **26571** SHADE B/F-W 2M
- 📁 **26590** STOPPER F
- 📁 **26596** HANDLE B/F

- profil / profil
- profil / profil
- difuzor / difúzor
- difuzor / difúzor
- difuzor / difúzor
- difuzor / difúzor
- záslepka / záslepka
- držák / držiak

- 🌀 eloxovaný hliník / eloxovaný hliník
- 🌀 eloxovaný hliník / eloxovaný hliník
- 🌀 transparentní / transparentný
- 🌀 transparentní / transparentný
- 🌀 bílá / biela
- 🌀 bílá / biela
- 🌀 šedá / šedá
- 🌀 nerez / nerez

PROFILO G - RECESSED FLOOR ALUMINIUM PROFILE



PROFILO G + SHADE CK G



l=1000/2000

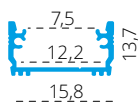

hliník

l=1000/2000



click

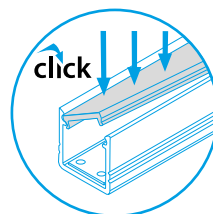

# PROFILO<sub>G</sub>

- }
click
  - }
    - }
      - }
        - }
          - }
            - }
              - }
                - }
                  - }
                    - }
                      - }
                        - }
                          - }
                            - }
                              - }
                                - }
                                  - }
                                    - }
                                      - }
  - }
  - }
  - }
  - }
  - }
  - }
  - }
  - }
  - }
  - }
  - }
  - }
  - }
  - }
  - }
  - }
  - }
  - }
  - }
  - }
  - }
  - }
  - }
  - }
  - }
  - }
  - }
  - }
  - }
  - }
  - }
  - }
  - }
  - }
  - }
  - }
  - }
  - }
  - }
  - }
  - }
  - }
  - }
  - }
  - }
  - }
  - }
  - }
  - }
  - }
  - }
  - }
  - }
  - }
  - }
  - }
  - }
  - }
  - }
  - }
  - }
  - }
  - }
  - }
  - }
  - }
  - }
  - }
  - }
  - }
  - }
  - }
  - }
  - }
  - }
  - }
  - }
  - }
  - }
  - }
  - }
  - }
  - }
  - }
  - }
  - }
  - }
  - }
  - }
  - }
  - }
  - }
  - }
  - }
  - }
  - }
  - }
  - }
  - }
  - }
  - }
  - }
  - }
  - }
  - }
  - }
  - }
  - }
  - }
  - }
  - }
  - }
  - }
  - }
  - }
  - }
  - }
  - }
  - }
  - }
  - }
  - }
  - }
  - }
  - }
  - }
  - }
  - }
  - }
  - }
  - }
  - }
  - }
  - }
  - }
  - }
  - }
  - }
  - }
  - }
  - }
  - }
  - }
  - }
  - }
  - }
  - }
  - }
  - }
  - }
  -

PROFILO H - FLEXIBLE ALUMINIUM PROFILE



PROFILO H + SHADE Ø H-W

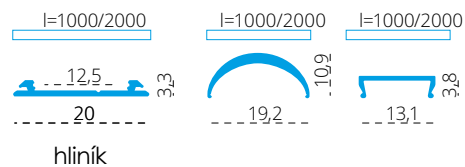
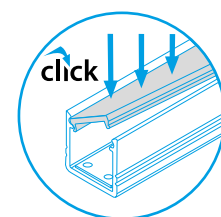

# PROFILO<sub>H</sub>

|       |       |                 |                     |                                     |
|-------|-------|-----------------|---------------------|-------------------------------------|
| click | 26560 | PROFILO H       | profil / profil     | eloxovaný hliník / eloxovaný hliník |
|       | 26561 | PROFILO H 2M    | profil / profil     | eloxovaný hliník / eloxovaný hliník |
|       | 26582 | SHADE-U H-FR    | difuzor / difúzor   | transparentní / transparentný       |
|       | 26583 | SHADE-U H-FR 2M | difuzor / difúzor   | transparentní / transparentný       |
|       | 26584 | SHADE-U H-W     | difuzor / difúzor   | bílá / biela                        |
|       | 26585 | SHADE-U H-W 2M  | difuzor / difúzor   | bílá / biela                        |
|       | 26586 | SHADE-O H-W     | difuzor / difúzor   | bílá / biela                        |
|       | 26587 | SHADE-O H-W 2M  | difuzor / difúzor   | bílá / biela                        |
|       | 26593 | STOPPER-U H     | záslepka / záslepka | šedá / šedá                         |
|       | 26594 | STOPPER-O H     | záslepka / záslepka | šedá / šedá                         |
|       | 26599 | HANDLE H        | držák / držiak      | nerez / nerez                       |
|       | 26600 | HANDLE SIDE H   | držák / držiak      | šedá / šedá                         |





PROFILO I - A RECESSED PROFILE WHICH CAN GIVE COUNTINOUS LINE EFFECT

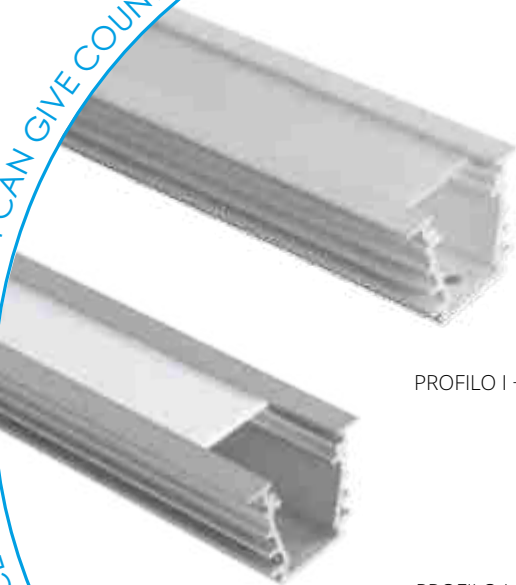

PROFILO I + SHADE c/D/E/I-FR

PROFILO I + SHADE c/D/E/I-W

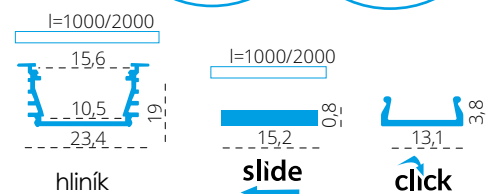
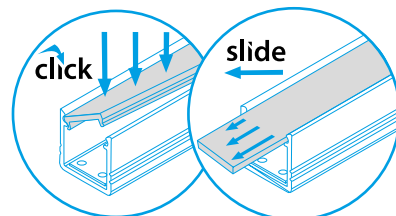
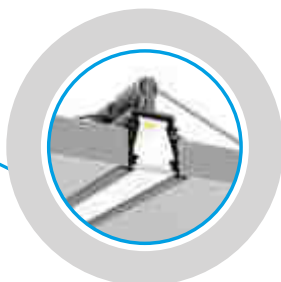
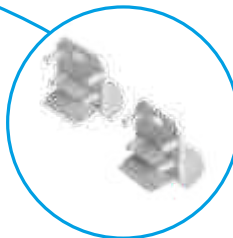

# PROFILO I

|       |       |                       |                              |                                     |
|-------|-------|-----------------------|------------------------------|-------------------------------------|
| slide | 26554 | PROFILO I             | profil / profil              | eloxovaný hliník / eloxovaný hliník |
|       | 26555 | PROFILO I 2M          | profil / profil              | eloxovaný hliník / eloxovaný hliník |
|       | 26556 | PROFILO I-W           | difúzor / difúzor            | bílá / biela                        |
|       | 26557 | PROFILO I-W 2M        | difúzor / difúzor            | bílá / biela                        |
|       | 26572 | SHADE C/D/E/I-FR      | difúzor / difúzor            | transparentní / transparentný       |
|       | 26573 | SHADE C/D/E/I-FR 2M   | difúzor / difúzor            | transparentní / transparentný       |
|       | 26574 | SHADE C/D/E/I-W       | difúzor / difúzor            | bílá / biela                        |
|       | 26575 | SHADE C/D/E/I-W 2M    | difúzor / difúzor            | bílá / biela                        |
|       | 26576 | SHADE CK C/D/E/I-FR   | difúzor / difúzor            | transparentní / transparentný       |
|       | 26577 | SHADE CK C/D/E/I-FR2M | difúzor / difúzor            | transparentní / transparentný       |
| click | 26578 | SHADE CK C/D/E/I-W    | difúzor / difúzor            | bílá / biela                        |
|       | 26579 | SHADE CK C/D/E/I-W 2M | difúzor / difúzor            | bílá / biela                        |
|       | 26591 | STOPPER I             | záslepka / záslepka          | šedá / šedá                         |
|       | 26603 | STOPPER I-W           | záslepka / záslepka          | bílá / biela                        |
|       | 26563 | CONNECT C/D/E/I       | spojka / spojka              | hliník / hliník                     |
|       | 26597 | HANDLE C/D/E/I        | držák / držiak               | nerez / nerez                       |
|       | 26601 | SPRING I              | držák do SDK / držiak do SDK | hliník / hliník                     |

PROFILO J - BASIC SURFACE ALUMINIUM PROFILE

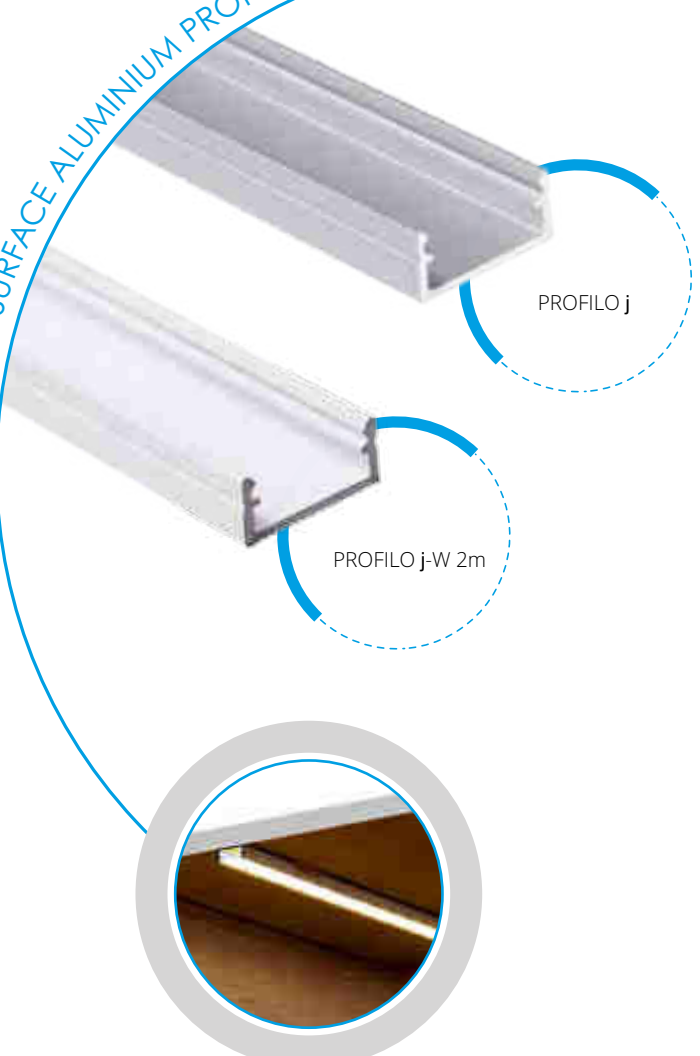

PROFILO j

PROFILO j-W 2m

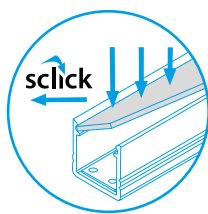
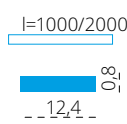
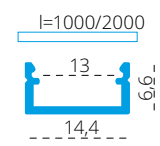
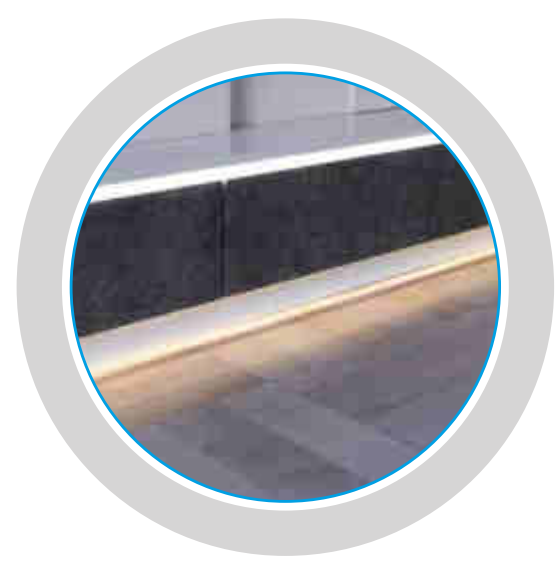
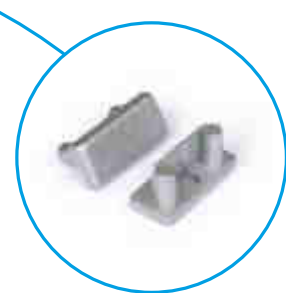

# PROFILO<sub>J</sub>

hliník

click



- 📁 26544 PROFILO J
- 📁 26545 PROFILO J 2M
- 📁 26546 PROFILO J-W
- 📁 26547 PROFILO J-W 2M
- 📁 26564 SHADE J/K-FR
- 📁 26566 SHADE J/K-FR 2M
- 📁 26565 SHADE J/K-W
- 📁 26567 SHADE J/K-W 2M
- 📁 26588 STOPPER J
- 📁 26605 STOPPER J-W
- 📁 26595 HANDLE J/K

profil / profil

profil / profil

profil / profil

profil / profil

difuzor / difúzor

difuzor / difúzor

difuzor / difúzor

difuzor / difúzor

záslepka / záslepka

záslepka / záslepka

držák / držiak

🌀 eloxovaný hliník / eloxovaný hliník

🌀 eloxovaný hliník / eloxovaný hliník

🌀 bílá / biela

🌀 bílá / biela

🌀 transparentní / transparentný

🌀 transparentní / transparentný

🌀 bílá / biela

🌀 bílá / biela

🌀 šedá / šedá

🌀 bílá / biela

🌀 nerez / nerez

PROFILO K - SMALL RECESSED ALUMINIUM PROFILE

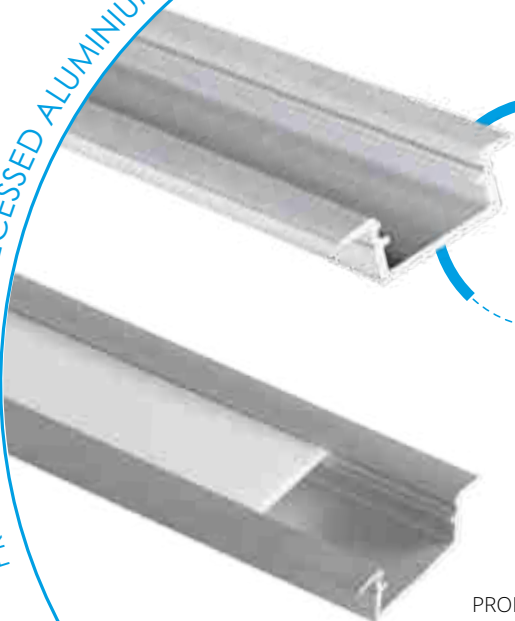

PROFILO K

PROFILO K + SHADE j/K-W

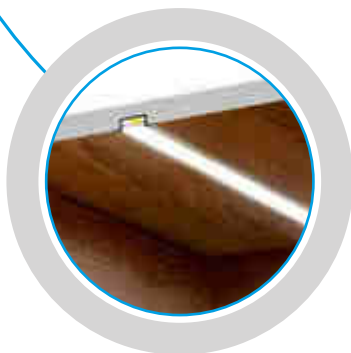
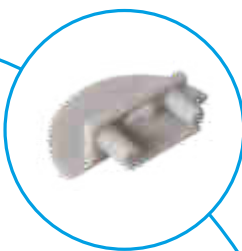

# PROFILO<sub>K</sub>

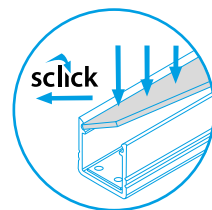
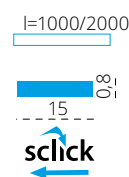
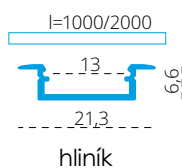

- 26548 PROFILO K
- 26549 PROFILO K 2M
- 26550 PROFILO K-W
- 26551 PROFILO K-W 2M
- 26564 SHADE J/K-FR
- 26566 SHADE J/K-FR 2M
- 26565 SHADE J/K-W
- 26567 SHADE J/K-W 2M
- 26589 STOPPER K
- 26606 STOPPER K-W
- 26595 HANDLE J/K

- profil / profil
- profil / profil
- profil / profil
- profil / profil
- difuzor / difúzor
- difuzor / difúzor
- difuzor / difúzor
- difuzor / difúzor
- záslepka / záslepka
- záslepka / záslepka
- držák / držiak

- eloxovaný hliník / eloxovaný hliník
- eloxovaný hliník / eloxovaný hliník
- bílá / biela
- bílá / biela
- transparentní / transparentný
- transparentní / transparentný
- bílá / biela
- bílá / biela
- šedá / šedá
- bílá / biela
- nerez / nerez