

PROFILO_A



- 📁 19160 PROFILO A
- 📁 19170 SHADE A-FR
- 📁 19190 HANDLE A

- profil / profil
- difúzor / difúzor
- držák / držiak

- 🔩 eloxovaný hliník / eloxovaný hliník
- 🔩 transparentní / transparentný
- 🔩 nerez / nerez

PROFILO B - SMALL SURFACE ALUMINIUM PROFILE

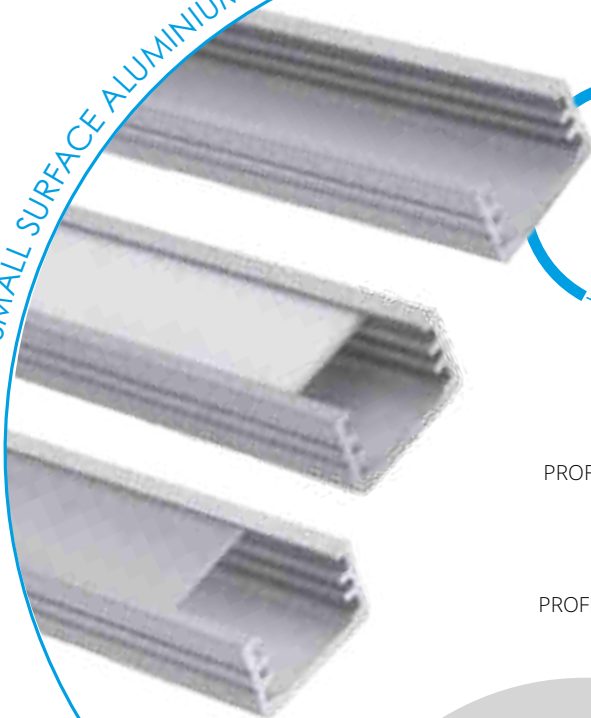

PROFILO B

PROFILO B + SHADE B/F-W

PROFILO B + SHADE B/F-FR

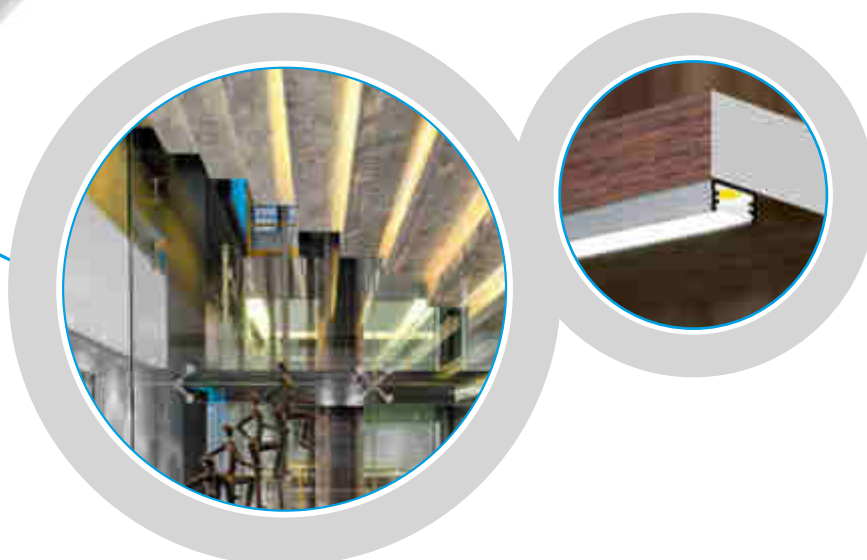
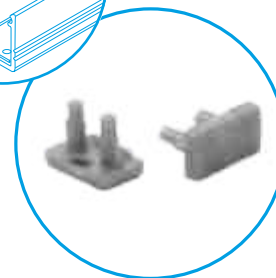
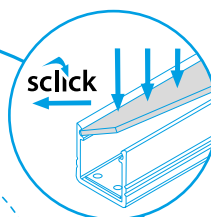

PROFILO_B

I=1000/2000



hliník

I=1000/2000



sclick



- 📁 19161 PROFILO B
- 📁 26540 PROFILO B 2M
- 📁 26568 SHADE B/F-FR
- 📁 26569 SHADE B/F-W
- 📁 26570 SHADE B/F-FR 2M
- 📁 26571 SHADE B/F-W 2M
- 📁 26596 HANDLE B/F
- 📁 26604 CONNECT-L B
- 📁 19181 STOPPER B

- profil / profil
- profil / profil
- difuzor / difúzor
- difuzor / difúzor
- difuzor / difúzor
- difuzor / difúzor
- držák / držiak
- spojka / spojka
- záslepka / záslepka

- 🌀 eloxovaný hliník / eloxovaný hliník
- 🌀 eloxovaný hliník / eloxovaný hliník
- 🌀 transparentní / transparentný
- 🌀 bílá / biela
- 🌀 transparentní / transparentný
- 🌀 bílá / biela
- 🌀 nerez / nerez
- 🌀 hliník / hliník
- 🌀 šedá / šedá

PROFILO C - CORNER ALUMINIUM PROFILE (ANGULAR 30°, 60°)

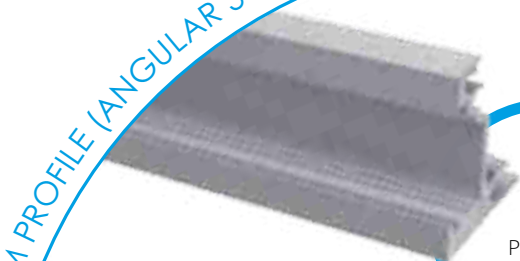

PROFILO c

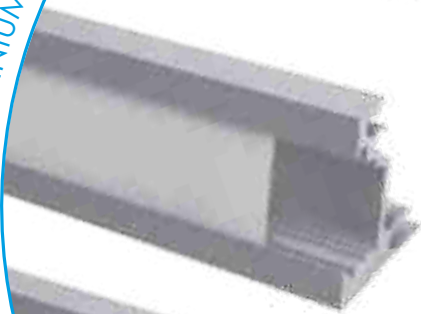

PROFILO c + SHADE c/D/E/I-W

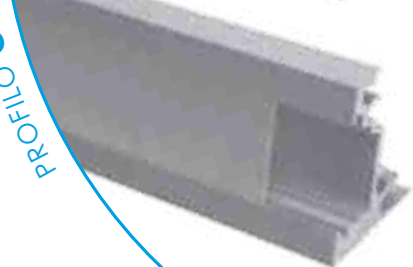

PROFILO c + SHADE c/D/E/I-FR

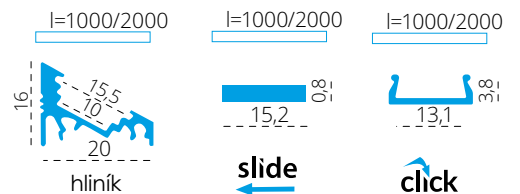
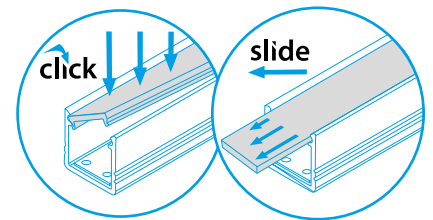
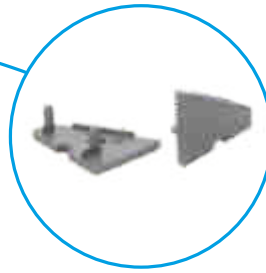

PROFILO_C

- 19162 PROFILO C
- 26541 PROFILO C 2M
- 26572 SHADE C/D/E/I-FR
- 26573 SHADE C/D/E/I-FR 2M
- 26574 SHADE C/D/E/I-W
- 26575 SHADE C/D/E/I-W 2M
- 26576 SHADE CK C/D/E/I-FR
- 26577 SHADE CK C/D/E/I-FR2M
- 26578 SHADE CK C/D/E/I-W
- 26579 SHADE CK C/D/E/I-W 2M
- 19182 STOPPER C
- 19191 HANDLE C/D/E
- 26562 CONNECT-L C
- 26597 HANDLE C/D/E/I

- profil / profil
- profil / profil
- difuzor / difúzor
- difuzor / difúzor
- difuzor / difúzor
- difuzor / difúzor
- difuzor / difúzor
- difuzor / difúzor
- difuzor / difúzor
- difuzor / difúzor
- záslepka / záslepka
- držák / držiak
- spojka / spojka
- držák / držiak

- eloxovaný hliník / eloxovaný hliník
- eloxovaný hliník / eloxovaný hliník
- transparentní / transparentný
- transparentní / transparentný
- bílá / biela
- bílá / biela
- transparentní / transparentný
- transparentní / transparentný
- bílá / biela
- bílá / biela
- šedá / šedá
- nerez / nerez
- hliník / hliník
- hliník / hliník

PROFILO D - SURFACE ALUMINIUM PROFILE

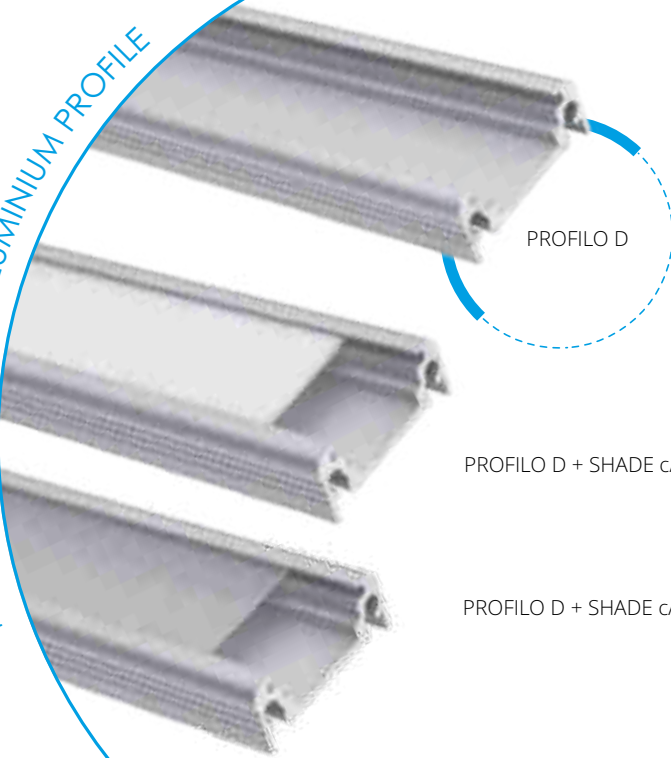

PROFILO D

PROFILO D + SHADE c/D/E/I-W

PROFILO D + SHADE c/D/E/I-FR

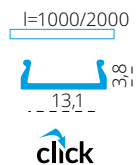
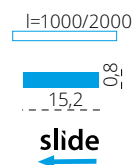
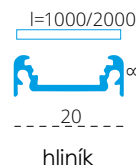
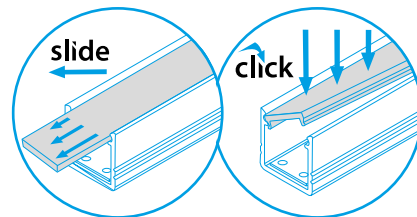
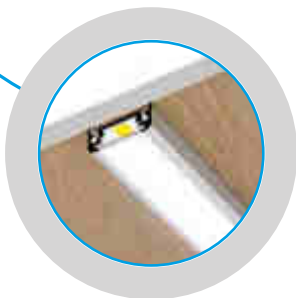

PROFILO_D

slide	19163	PROFILO D	profil / profil	eloxovaný hliník / eloxovaný hliník
	26542	PROFILO D 2M	profil / profil	eloxovaný hliník / eloxovaný hliník
	26572	SHADE C/D/E/I-FR	difuzor / difúzor	transparentní / transparentný
	26573	SHADE C/D/E/I-FR 2M	difuzor / difúzor	transparentní / transparentný
	26574	SHADE C/D/E/I-W	difuzor / difúzor	bílá / biela
click	26575	SHADE C/D/E/I-W 2M	difuzor / difúzor	bílá / biela
	26576	SHADE CK C/D/E/I-FR	difuzor / difúzor	transparentní / transparentný
	26577	SHADE CK C/D/E/I-FR2M	difuzor / difúzor	transparentní / transparentný
	26578	SHADE CK C/D/E/I-W	difuzor / difúzor	bílá / biela
	26579	SHADE CK C/D/E/I-W 2M	difuzor / difúzor	bílá / biela
	19183	STOPPER D	záslepka / záslepka	šedá / šedá
	26597	HANDLE C/D/E/I	držák / držiak	nerez / nerez
	26563	CONNECT C/D/E/I	spojka / spojka	hliník / hliník



PROFILO E - ANGULAR 45°

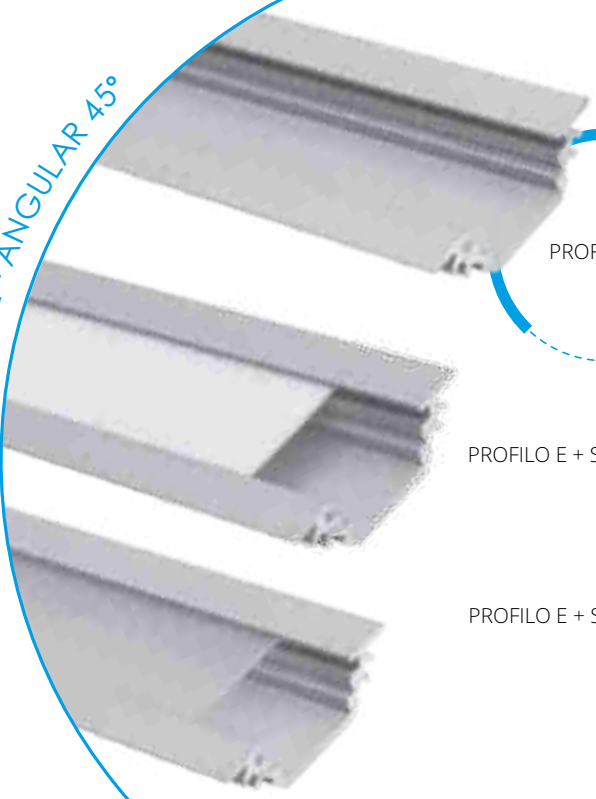

PROFILO E

PROFILO E + SHADE C/D/E/I-W

PROFILO E + SHADE C/D/E/I-FR

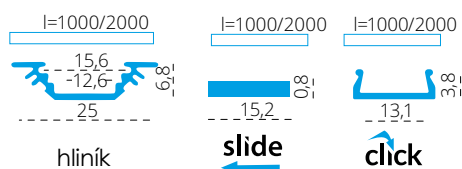
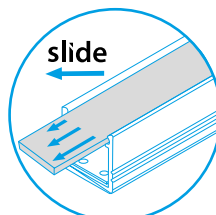
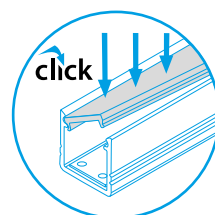
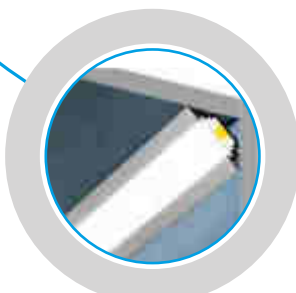
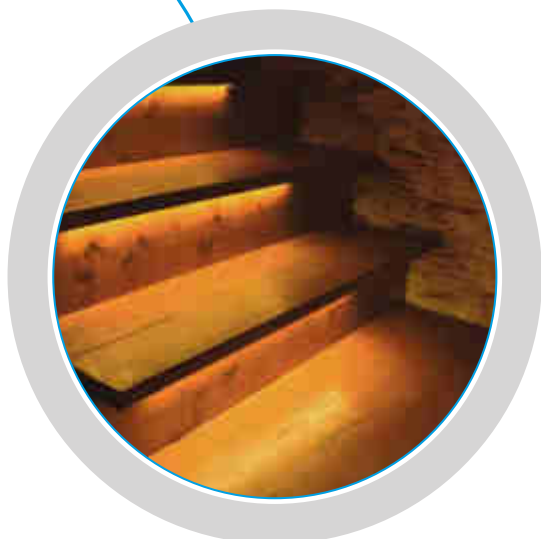

PROFILO_E

slide	19164	PROFILO E	profil / profil	eloxovaný hliník / eloxovaný hliník
	26543	PROFILO E 2M	profil / profil	eloxovaný hliník / eloxovaný hliník
	26572	SHADE C/D/E/I-FR	difúzor / difúzor	transparentní / transparentný
	26573	SHADE C/D/E/I-FR 2M	difúzor / difúzor	transparentní / transparentný
	26574	SHADE C/D/E/I-W	difúzor / difúzor	bílá / biela
click	26575	SHADE C/D/E/I-W 2M	difúzor / difúzor	bílá / biela
	26576	SHADE CK C/D/E/I-FR	difúzor / difúzor	transparentní / transparentný
	26577	SHADE CK C/D/E/I-FR2M	difúzor / difúzor	transparentní / transparentný
	26578	SHADE CK C/D/E/I-W	difúzor / difúzor	bílá / biela
	26579	SHADE CK C/D/E/I-W 2M	difúzor / difúzor	bílá / biela
	19184	STOPPER E	záslepka / záslepka	šedá / šedá
	26597	HANDLE C/D/E	držák / držiak	nerez / nerez
	26563	CONNECT C/D/E	spojka / spojka	hliník / hliník

PROFILO F - TALL SURFACE ALUMINIUM PROFILE

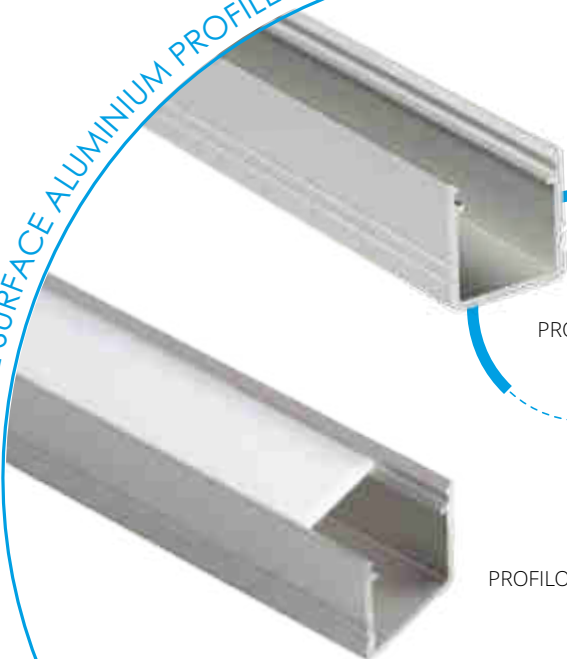

PROFILO F

PROFILO F + SHADE B/F-

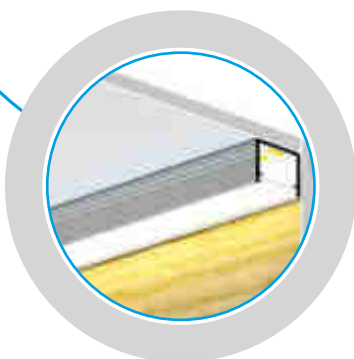
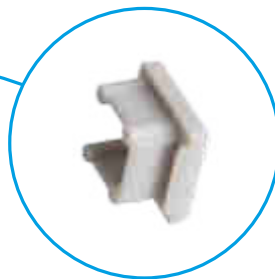

PROFILO_F

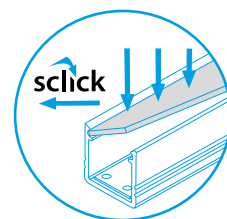
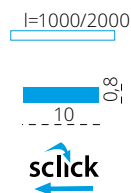
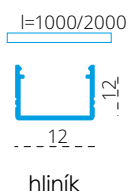

- 📁 **26552** PROFILO F
- 📁 **26553** PROFILO F 2M
- 📁 **26568** SHADE B/F-FR
- 📁 **26570** SHADE B/F-FR 2M
- 📁 **26569** SHADE B/F-W
- 📁 **26571** SHADE B/F-W 2M
- 📁 **26590** STOPPER F
- 📁 **26596** HANDLE B/F

- profil / profil
- profil / profil
- difuzor / difúzor
- difuzor / difúzor
- difuzor / difúzor
- difuzor / difúzor
- záslepka / záslepka
- držák / držiak

- 🌀 eloxovaný hliník / eloxovaný hliník
- 🌀 eloxovaný hliník / eloxovaný hliník
- 🌀 transparentní / transparentný
- 🌀 transparentní / transparentný
- 🌀 bílá / biela
- 🌀 bílá / biela
- 🌀 šedá / šedá
- 🌀 nerez / nerez

PROFILO G - RECESSED FLOOR ALUMINIUM PROFILE



PROFILO G + SHADE CK G



l=1000/2000

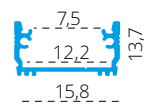

hliník

l=1000/2000

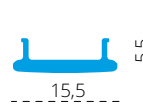

click

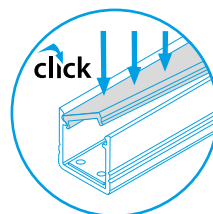

PROFILO_G

- 📁 26558 PROFILO G
- 📁 26559 PROFILO G 2M
- 📁 26580 SHADE CK G
- click { 📁 26581 SHADE CK G 2M
- 📁 26592 STOPPER G
- 📁 26598 HANDLE G
- 📁 26602 SEALINGS G

- profil / profil
- profil / profil
- difúzor / difúzor
- difúzor / difúzor
- záslepka / záslepka
- držák / držiak
- tesnení / tesnenie

- 🌀 eloxovaný hliník / eloxovaný hliník
- 🌀 eloxovaný hliník / eloxovaný hliník
- 🌀 bílá / biela
- 🌀 bílá / biela
- 🌀 šedá / šedá
- 🌀 nerez / nerez
- 🌀 šedá / šedá

PROFILO H - FLEXIBLE ALUMINIUM PROFILE



PROFILO H + SHADE Ø H-W

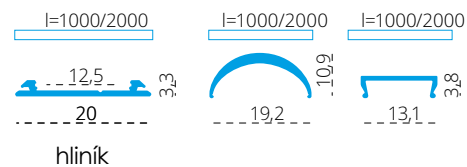
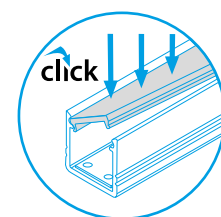

PROFILO_H

click	26560 PROFILO H	profil / profil	eloxovaný hliník / eloxovaný hliník
	26561 PROFILO H 2M	profil / profil	eloxovaný hliník / eloxovaný hliník
	26582 SHADE-U H-FR	difuzor / difúzor	transparentní / transparentný
	26583 SHADE-U H-FR 2M	difuzor / difúzor	transparentní / transparentný
	26584 SHADE-U H-W	difuzor / difúzor	bílá / biela
	26585 SHADE-U H-W 2M	difuzor / difúzor	bílá / biela
	26586 SHADE-O H-W	difuzor / difúzor	bílá / biela
	26587 SHADE-O H-W 2M	difuzor / difúzor	bílá / biela
	26593 STOPPER-U H	záslepka / záslepka	šedá / šedá
	26594 STOPPER-O H	záslepka / záslepka	šedá / šedá
	26599 HANDLE H	držák / držiak	nerez / nerez
	26600 HANDLE SIDE H	držák / držiak	šedá / šedá



PROFILO I - A RECESSED PROFILE WHICH CAN GIVE COUNTINOUS LINE EFFECT

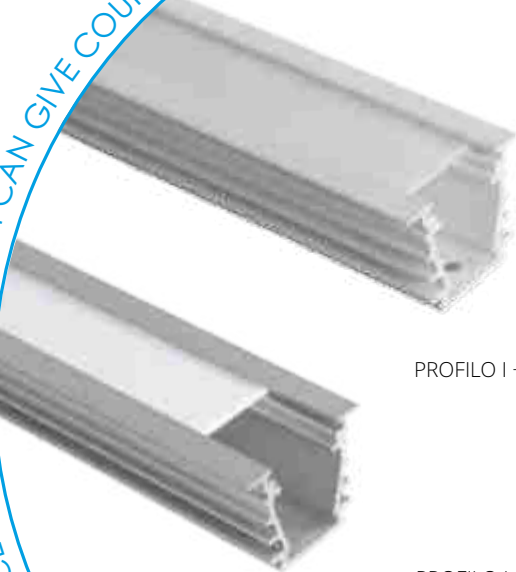

PROFILO I + SHADE c/D/E/I-FR

PROFILO I + SHADE c/D/E/I-W

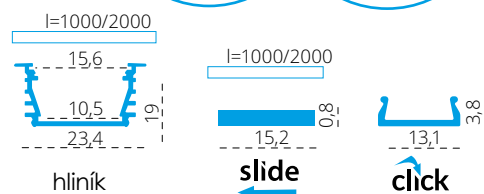
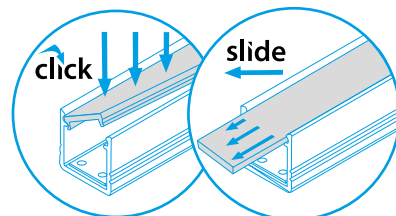
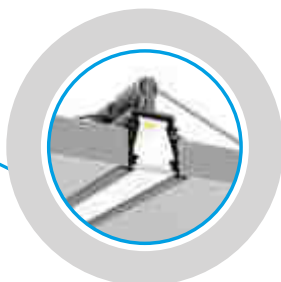
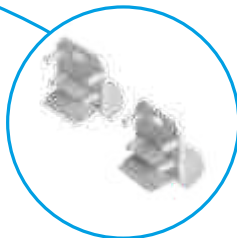

PROFILO I

slide	26554	PROFILO I	profil / profil	eloxovaný hliník / eloxovaný hliník	
	26555	PROFILO I 2M	profil / profil	eloxovaný hliník / eloxovaný hliník	
	26556	PROFILO I-W	difúzor / difúzor	bílá / biela	
	26557	PROFILO I-W 2M	difúzor / difúzor	bílá / biela	
	26572	SHADE C/D/E/I-FR	difúzor / difúzor	transparentní / transparentný	
	26573	SHADE C/D/E/I-FR 2M	difúzor / difúzor	transparentní / transparentný	
	26574	SHADE C/D/E/I-W	difúzor / difúzor	bílá / biela	
	26575	SHADE C/D/E/I-W 2M	difúzor / difúzor	bílá / biela	
	click	26576	SHADE CK C/D/E/I-FR	difúzor / difúzor	transparentní / transparentný
		26577	SHADE CK C/D/E/I-FR2M	difúzor / difúzor	transparentní / transparentný
26578		SHADE CK C/D/E/I-W	difúzor / difúzor	bílá / biela	
26579		SHADE CK C/D/E/I-W 2M	difúzor / difúzor	bílá / biela	
	26591	STOPPER I	záslepka / záslepka	šedá / šedá	
	26603	STOPPER I-W	záslepka / záslepka	bílá / biela	
	26563	CONNECT C/D/E/I	spojka / spojka	hliník / hliník	
	26597	HANDLE C/D/E/I	držák / držiak	nerez / nerez	
	26601	SPRING I	držák do SDK / držiak do SDK	hliník / hliník	

PROFILO J - BASIC SURFACE ALUMINIUM PROFILE

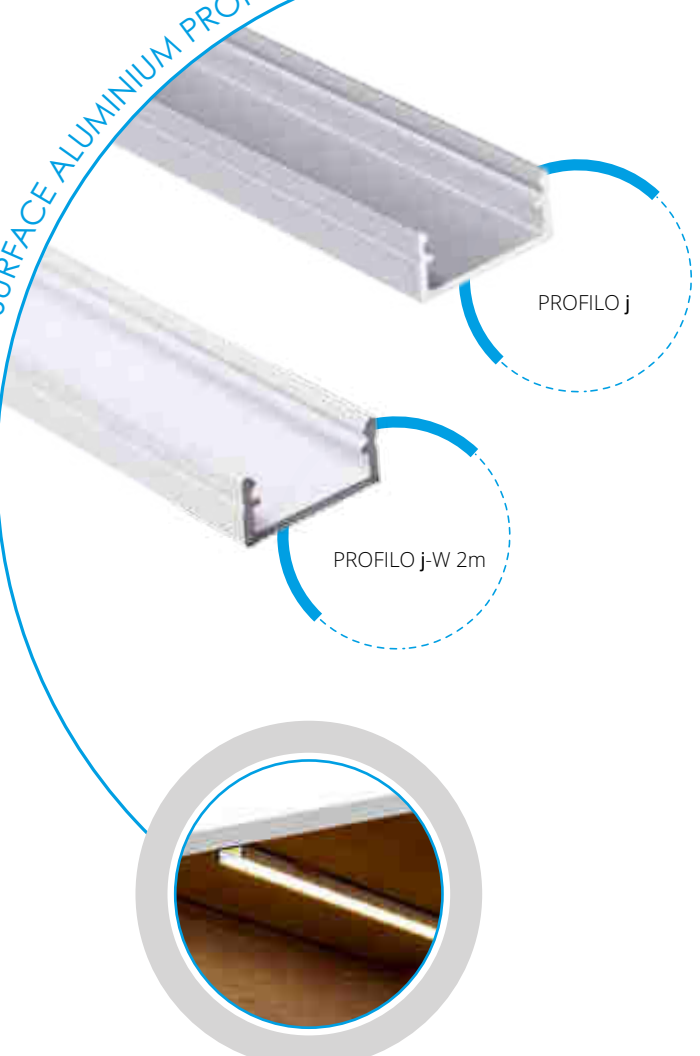

PROFILO j

PROFILO j-W 2m

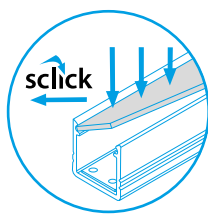
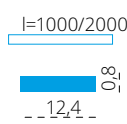
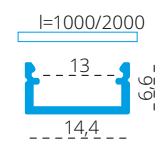
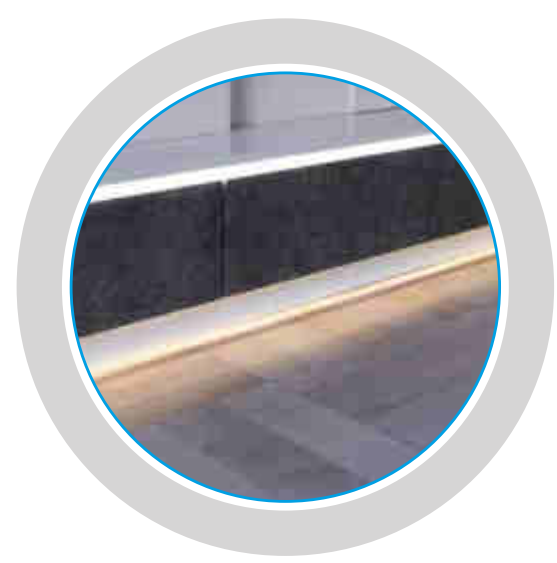
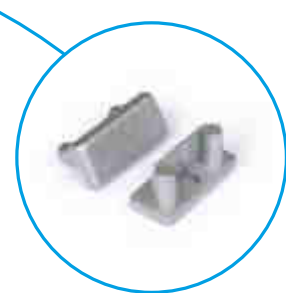

PROFILO_J



26544	PROFILO J	profil / profil	eloxovaný hliník / eloxovaný hliník
26545	PROFILO J 2M	profil / profil	eloxovaný hliník / eloxovaný hliník
26546	PROFILO J-W	profil / profil	bílá / biela
26547	PROFILO J-W 2M	profil / profil	bílá / biela
26564	SHADE J/K-FR	difúzor / difúzor	transparentní / transparentný
26566	SHADE J/K-FR 2M	difúzor / difúzor	transparentní / transparentný
26565	SHADE J/K-W	difúzor / difúzor	bílá / biela
26567	SHADE J/K-W 2M	difúzor / difúzor	bílá / biela
26588	STOPPER J	záslepka / záslepka	šedá / šedá
26605	STOPPER J-W	záslepka / záslepka	bílá / biela
26595	HANDLE J/K	držák / držiak	nerez / nerez

PROFILO K - SMALL RECESSED ALUMINIUM PROFILE

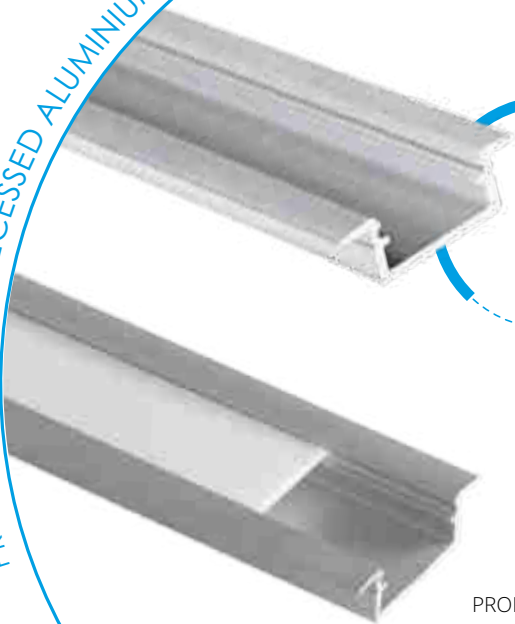

PROFILO K

PROFILO K + SHADE j/K-W

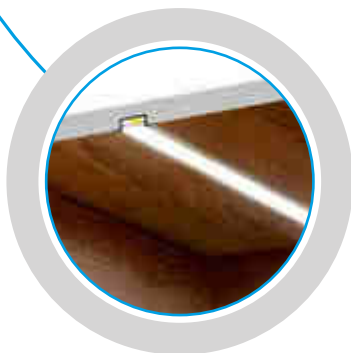
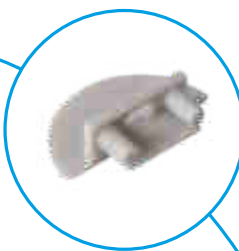

PROFILO_K

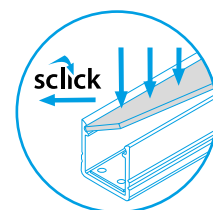
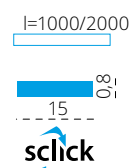
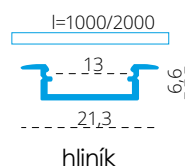

26548 PROFILO K	profil / profil	eloxovaný hliník / eloxovaný hliník
26549 PROFILO K 2M	profil / profil	eloxovaný hliník / eloxovaný hliník
26550 PROFILO K-W	profil / profil	bílá / biela
26551 PROFILO K-W 2M	profil / profil	bílá / biela
26564 SHADE J/K-FR	difuzor / difúzor	transparentní / transparentný
26566 SHADE J/K-FR 2M	difuzor / difúzor	transparentní / transparentný
26565 SHADE J/K-W	difuzor / difúzor	bílá / biela
26567 SHADE J/K-W 2M	difuzor / difúzor	bílá / biela
26589 STOPPER K	záslepka / záslepka	šedá / šedá
26606 STOPPER K-W	záslepka / záslepka	bílá / biela
26595 HANDLE J/K	držák / držiak	nerez / nerez