

Volt





Volt

Light fixtures for exterior equipped with SMD LEDs, die cast aluminium housing electrostatically painted in dark grey, corten or dark green, opal polycarbonate diffuser.
Bollards available also in versions with power sockets at 230V AC, with or without light source.



Corpuri de iluminat pentru exterior echipate cu LED-uri SMD, corp din aluminiu turnat sub presiune vopsit în câmp electrostatic gri închis, corten sau verde închis, dispersor din policarbonat opal.
Stâlpișori disponibili și în versiuni cu prize de alimentare 230V AC, cu sau fără sursă de iluminat.

Apparecchi per esterni equipaggiati con LED SMD, corpo in pressofusione di alluminio verniciato a polveri grigio scuro, corten o verde scuro, diffusore in policarbonato opalino.
Paletti disponibili anche nelle versioni con prese di corrente 230V AC, con o senza sorgente luminosa.

Светильники для наружного освещения, оснащенные светодиодами SMD, корпус из литого под давлением алюминия, окрашенный в электростатическом поле в темно-серый, цвет кортеновской стали или темно-зеленый, рассеиватель из опалового поликарбоната.
Столбики поставляются также с разъемами 230 В переменного тока, с источником света или без него.

Kültéri, SMD LED-es, nyomás alatt öntött, sötétszürke, corten vagy sötétzöld színű porfestett, alumínium test, opál polikarbonát árnyékoló.
Az oszlopok 230 V AC aljzatos, fényforrással vagy fényforrás nélkül is rendelkezésre állnak.

Осветительни тела за екстериор, оборудвани с LED-ове SMD, алуминиево тяло, излято под налягане, боядисано в электростатично поле в тъмно сиво, кортен или тъмно зелено, опален поликарбонатен дифузер.

Стълбовете се предлагат и във версия с контакти за захранване 230 V AC, със или без източник на осветление.

Exteriérové svietidlá vybavené SMD LED diódami, hliníkový odliatok elektrostaticky lakovaný v tmavosivej, cortenovej alebo tmavozelenej farbe, opálový polykarbonátový difúzor.
Stĺpiky dostupné aj vo verziách so zásuvkami na 230V AC, so svetelným zdrojom alebo bez neho.



BOLLARD • STÂLPÎȘOR

Code	Finishing	Socket
90611	Dark Grey	Twilight and motion
90612	Corten	Twilight and motion
90613	Dark Green	Twilight and motion

LED type	Input voltage	Power	CCT	Luminous Flux Source/system	CRI
SMD LED 2835, 36 pcs	220-240V, 50/60Hz	13W	3000K	1200/895 lm	≥80

BOLLARD • STÂLPÎȘOR

Code	Finishing	Socket
90608	Dark Grey	Twilight and motion
90609	Corten	Twilight and motion
90610	Dark Green	Twilight and motion

LED type	Input voltage	Power	CCT	Luminous Flux Source/system	CRI
SMD LED 2835, 36 pcs	220-240V, 50/60Hz	13W	3000K	1200/895 lm	≥80

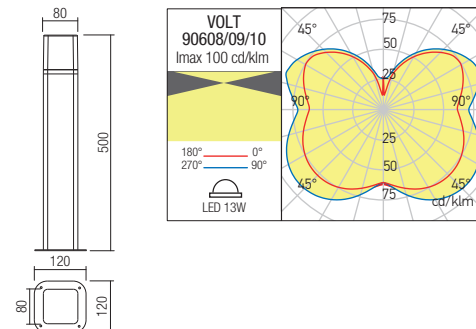
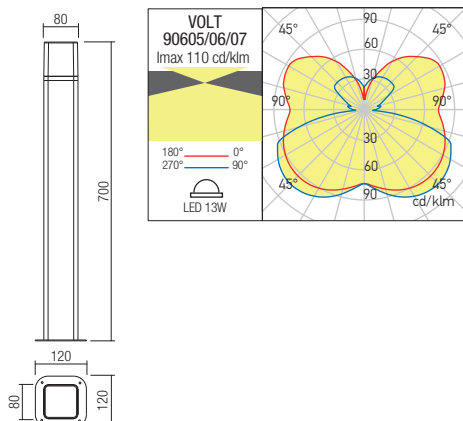

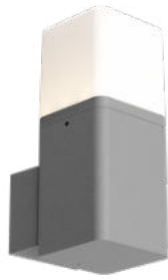

WALL LAMP • APLICĂ

Code	Finishing	Socket
90605	Dark Grey	Twilight and motion
90606	Corten	Twilight and motion
90607	Dark Green	Twilight and motion

LED type	Input voltage	Power	CCT	Luminous Flux Source/system	CRI
SMD LED 2835, 36 pcs	220-240V, 50/60Hz	13W	3000K	1200/895 lm	≥80

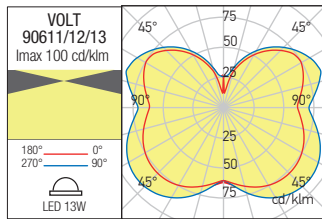
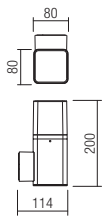

BOLLARD • STÂLPIȘOR

Code	Finishing	Socket
90614	Dark Grey	Twilight and motion
90615	Corten	Twilight and motion
90616	Dark Green	Twilight and motion

LED type	Input voltage	Power	CCT	Luminous Flux Source/system	CRI	Socket
SMD LED 2835, 36 pcs	220-240V, 50/60Hz	13W	3000K	1200/895 lm	≥80	2 × 230VAC

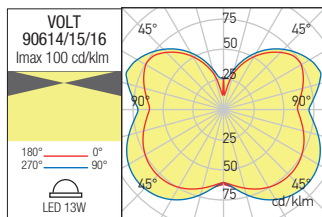
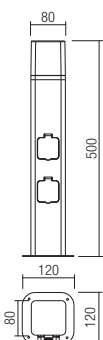

BOLLARD • STÂLPIȘOR

Code	Finishing	Socket
90617	Dark Grey	Twilight and motion
90618	Corten	Twilight and motion
90619	Dark Green	Twilight and motion

Input voltage	Socket
220-240V, 50/60Hz	2 × 230VAC

