

SOVERT

ARENA-I

Průmyslové vysoce výkonné LED svítidlo s vysokou odolností proti nárazu



Základna materiál:	hliník
Těsnění:	silikon
Difuzor materiál:	PC – polykarbonát
Životnost LED:	L90/B10 – 50 000 h
Distribuce světla:	přímá
Elektro vybavení:	LED moduly, nestmívatelný napaječ ON/OFF
Třída ochrany IEC:	I
Instalace:	přisazená, závěsná
Barva povrchu:	<input type="radio"/> bílá
Teplota chromatičnosti:	4000K

PRŮMYSL SPORTOVIŠTĚ SKLADOVACÍ HALY DÍLNY
GARÁŽE

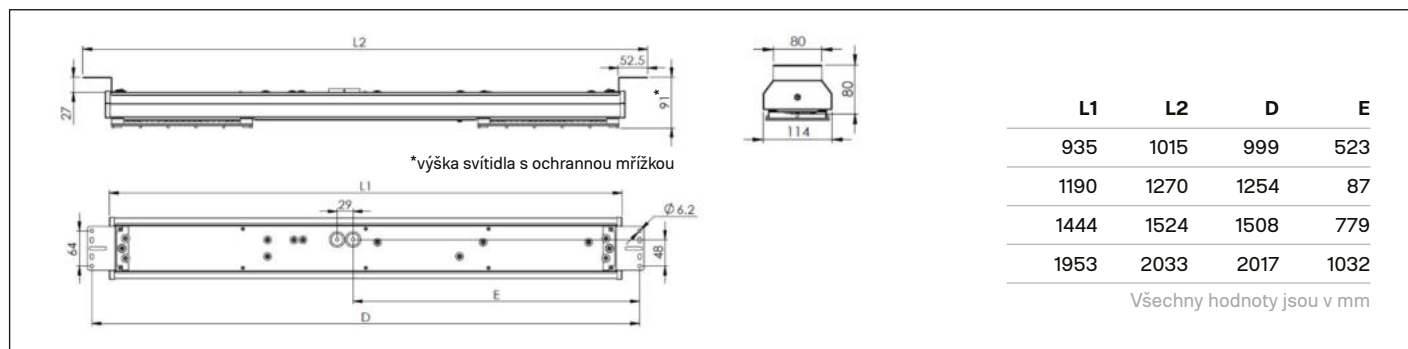
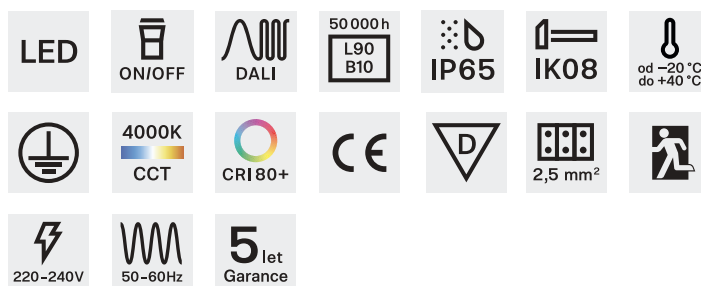

Typ produktu	Příkon	Světelný tok svítidla	Účinnost svítidla	Hmotnost	Délka	Kódy produktu	
ARENA-I optic 30×70°	W	lm	lm/W	kg	mm	ON/OFF	DALI
ARENA-I 1.3ft 10500/840 optic 30×70	59	9811	167	1.5	935	8422251	8422261
ARENA-I 1.3ft 12500/840 optic 30×70	70	11569	165	1.5	935	8423251	8423261
ARENA-I 1.3ft 14500/840 optic 30×70	83	13341	162	1.5	935	8424251	8424261
ARENA-I 1.4ft 16000/840 optic 30×70	86	14640	170	2.2	1190	8425251	8425261
ARENA-I 1.4ft 19000/840 optic 30×70	104	17353	167	2.2	1190	8427251	8427261
ARENA-I 1.4ft 22000/840 optic 30×70	122	19908	163	2.2	1190	8429251	8429261
ARENA-I 1.5ft 21000/840 optic 30×70	115	19521	170	2.8	1444	8428251	8428261
ARENA-I 1.5ft 25000/840 optic 30×70	139	23137	167	2.8	1444	8430251	8430261
ARENA-I 1.5ft 27000/840 optic 30×70	151	24759	164	2.8	1444	8431251	8431261
ARENA-I 1.5ft 28500/840 optic 30×70	163	26543	163	2.8	1444	8432251	8432261
ARENA-I 1.6ft 31500/840 optic 30×70	171	29130	170	4.1	1953	8433251	8433261
ARENA-I 1.6ft 37000/840 optic 30×70	207	34526	166	4.1	1953	8434251	8434261
ARENA-I 1.6ft 42500/840 optic 30×70	244	39608	163	4.1	1953	8435251	8435261

Světelná křivka a optika

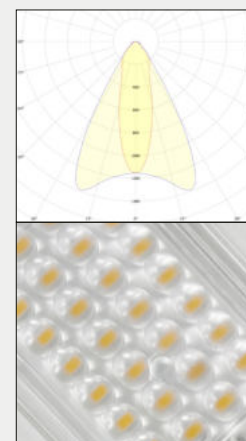

Typ produktu

ARENA-I optic 40°

	Příkon	Světelný tok svítidla	Účinnost svítidla	Hmotnost	Délka	Kódy produktu	
	W	lm	lm/W	kg	mm	ON/OFF	DALI
ARENA-I 1.3ft 10500/840 optic 40	59	10031	171	1.5	935	8422252	8422262
ARENA-I 1.3ft 12500/840 optic 40	70	11829	169	1.5	935	8423252	8423262
ARENA-I 1.3ft 14500/840 optic 40	83	13640	165	1.5	935	8424252	8424262
ARENA-I 1.4ft 16000/840 optic 40	86	14969	174	2.2	1190	8425252	8425262
ARENA-I 1.4ft 19000/840 optic 40	104	17743	171	2.2	1190	8427252	8427262
ARENA-I 1.4ft 22000/840 optic 40	122	20355	167	2.2	1190	8429252	8429262
ARENA-I 1.5ft 21000/840 optic 40	115	19959	174	2.8	1444	8428252	8428262
ARENA-I 1.5ft 25000/840 optic 40	139	23657	171	2.8	1444	8430252	8430262
ARENA-I 1.5ft 27000/840 optic 40	151	25315	167	2.8	1444	8431252	8431262
ARENA-I 1.5ft 28500/840 optic 40	163	27140	167	2.8	1444	8432252	8432262
ARENA-I 1.6ft 31500/840 optic 40	171	29784	174	4.1	1953	8433252	8433262
ARENA-I 1.6ft 37000/840 optic 40	207	35302	170	4.1	1953	8434252	8434262
ARENA-I 1.6ft 42500/840 optic 40	244	40499	166	4.1	1953	8435252	8435262

ARENA-I optic 60°

ARENA-I 1.3ft 10500/840 optic 60	59	10472	178	1.5	935	8422253	8422263
ARENA-I 1.3ft 12500/840 optic 60	70	12348	176	1.5	935	8423253	8423263
ARENA-I 1.3ft 14500/840 optic 60	83	14240	173	1.5	935	8424253	8424263
ARENA-I 1.4ft 16000/840 optic 60	86	15627	182	2.2	1190	8425253	8425263
ARENA-I 1.4ft 19000/840 optic 60	104	18523	178	2.2	1190	8427253	8427263
ARENA-I 1.4ft 22000/840 optic 60	122	21250	174	2.2	1190	8429253	8429263
ARENA-I 1.5ft 21000/840 optic 60	115	20837	182	2.8	1444	8428253	8428263
ARENA-I 1.5ft 25000/840 optic 60	139	24697	178	2.8	1444	8430253	8430263
ARENA-I 1.5ft 27000/840 optic 60	151	26428	175	2.8	1444	8431253	8431263
ARENA-I 1.5ft 28500/840 optic 60	163	28333	174	2.8	1444	8432253	8432263
ARENA-I 1.6ft 31500/840 optic 60	171	31094	181	4.1	1953	8433253	8433263
ARENA-I 1.6ft 37000/840 optic 60	207	36854	178	4.1	1953	8434253	8434263
ARENA-I 1.6ft 42500/840 optic 60	244	42279	174	4.1	1953	8435253	8435263

ARENA-I optic 75°

ARENA-I 1.3ft 10500/840 optic 75	59	10031	171	1.5	935	8422254	8422264
ARENA-I 1.3ft 12500/840 optic 75	70	11829	169	1.5	935	8423254	8423264
ARENA-I 1.3ft 14500/840 optic 75	83	13640	165	1.5	935	8424254	8424264
ARENA-I 1.4ft 16000/840 optic 75	86	14969	174	2.2	1190	8425254	8425264
ARENA-I 1.4ft 19000/840 optic 75	104	17743	171	2.2	1190	8427254	8427264
ARENA-I 1.4ft 22000/840 optic 75	122	20355	167	2.2	1190	8429254	8429264
ARENA-I 1.5ft 21000/840 optic 75	115	19959	174	2.8	1444	8428254	8428264
ARENA-I 1.5ft 25000/840 optic 75	139	23657	171	2.8	1444	8430254	8430264
ARENA-I 1.5ft 27000/840 optic 75	151	25315	168	2.8	1444	8431254	8431264
ARENA-I 1.5ft 28500/840 optic 75	163	27140	167	2.8	1444	8432254	8432264
ARENA-I 1.6ft 31500/840 optic 75	171	29784	174	4.1	1953	8433254	8433264
ARENA-I 1.6ft 37000/840 optic 75	207	35302	170	4.1	1953	8434254	8434264
ARENA-I 1.6ft 42500/840 optic 75	244	40499	166	4.1	1953	8435254	8435264

ARENA-I optic 90°

ARENA-I 1.3ft 10500/840 optic 90	59	9921	169	1.5	935	8422255	8422265
ARENA-I 1.3ft 12500/840 optic 90	70	11699	167	1.5	935	8423255	8423265
ARENA-I 1.3ft 14500/840 optic 90	83	13490	164	1.5	935	8424255	8424265
ARENA-I 1.4ft 16000/840 optic 90	86	14805	172	2.2	1190	8425255	8425265
ARENA-I 1.4ft 19000/840 optic 90	104	17548	169	2.2	1190	8427255	8427265
ARENA-I 1.4ft 22000/840 optic 90	122	20131	165	2.2	1190	8429255	8429265
ARENA-I 1.5ft 21000/840 optic 90	115	19740	172	2.8	1444	8428255	8428265
ARENA-I 1.5ft 25000/840 optic 90	139	23397	169	2.8	1444	8430255	8430265
ARENA-I 1.5ft 27000/840 optic 90	151	25037	166	2.8	1444	8431255	8431265
ARENA-I 1.5ft 28500/840 optic 90	163	26842	165	2.8	1444	8432255	8432265
ARENA-I 1.6ft 31500/840 optic 90	171	29457	172	4.1	1953	8433255	8433265
ARENA-I 1.6ft 37000/840 optic 90	207	34914	168	4.1	1953	8434255	8434265
ARENA-I 1.6ft 42500/840 optic 90	244	40054	164	4.1	1953	8435255	8435265

Světelná křivka a optika

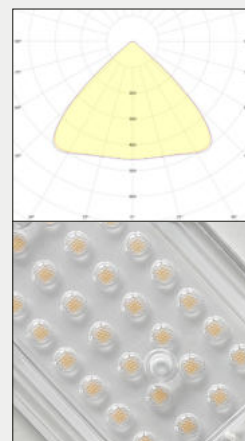
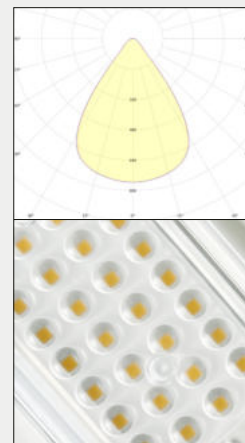
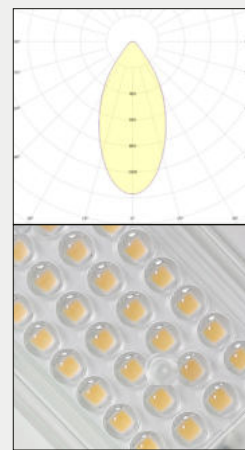
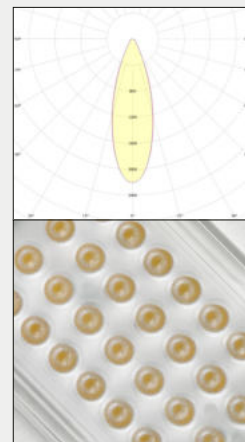

Typ produktu		Příkon	Světelný tok svítidla	Účinnost svítidla	Hmotnost	Délka	Kódy produktu	
ARENA-I optic 120°		W	lm	lm/W	kg	mm	ON/OFF	DALI
ARENA-I	1.3ft 10500/840 optic 120	59	10472	178	1.5	935	8422256	8422266
ARENA-I	1.3ft 12500/840 optic 120	70	12348	176	1.5	935	8423256	8423266
ARENA-I	1.3ft 14500/840 optic 120	83	14240	173	1.5	935	8424256	8424266
ARENA-I	1.4ft 16000/840 optic 120	86	15627	182	2.2	1190	8425256	8425266
ARENA-I	1.4ft 19000/840 optic 120	104	18523	178	2.2	1190	8427256	8427266
ARENA-I	1.4ft 22000/840 optic 120	122	21250	174	2.2	1190	8429256	8429266
ARENA-I	1.5ft 21000/840 optic 120	115	20837	182	2.8	1444	8428256	8428266
ARENA-I	1.5ft 25000/840 optic 120	139	24697	178	2.8	1444	8430256	8430266
ARENA-I	1.5ft 27000/840 optic 120	151	26428	175	2.8	1444	8431256	8431266
ARENA-I	1.5ft 28500/840 optic 120	163	28333	174	2.8	1444	8432256	8432266
ARENA-I	1.6ft 31500/840 optic 120	171	31094	181	4.1	1953	8433256	8433266
ARENA-I	1.6ft 37000/840 optic 120	207	36854	178	4.1	1953	8434256	8434266
ARENA-I	1.6ft 42500/840 optic 120	244	42279	174	4.1	1953	8435256	8435266

Světelná křivka a optika

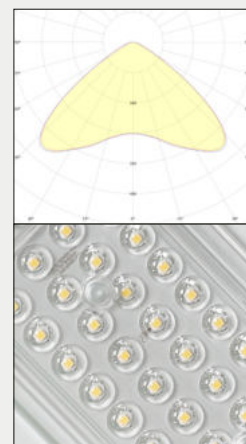

Typ produktu

ARENA-I optic AS

ARENA-I	1.3ft 10500/840 optic AS	59	9921	168	1.5	935	8422257	8422267
ARENA-I	1.3ft 12500/840 optic AS	70	11699	167	1.5	935	8423257	8423267
ARENA-I	1.3ft 14500/840 optic AS	83	13490	163	1.5	935	8424257	8424267
ARENA-I	1.4ft 16000/840 optic AS	86	14805	172	2.2	1190	8425257	8425267
ARENA-I	1.4ft 19000/840 optic AS	104	17548	169	2.2	1190	8427257	8427267
ARENA-I	1.4ft 22000/840 optic AS	122	20131	165	2.2	1190	8429257	8429267
ARENA-I	1.5ft 21000/840 optic AS	115	19740	172	2.8	1444	8428257	8428267
ARENA-I	1.5ft 25000/840 optic AS	139	23397	168	2.8	1444	8430257	8430267
ARENA-I	1.5ft 27000/840 optic AS	151	25037	166	2.8	1444	8431257	8431267
ARENA-I	1.5ft 28500/840 optic AS	163	26842	165	2.8	1444	8432257	8432267
ARENA-I	1.6ft 31500/840 optic AS	171	29457	172	4.1	1953	8433257	8433267
ARENA-I	1.6ft 37000/840 optic AS	207	34914	169	4.1	1953	8434257	8434267
ARENA-I	1.6ft 42500/840 optic AS	244	40054	164	4.1	1953	8435257	8435267

Světelná křivka a optika

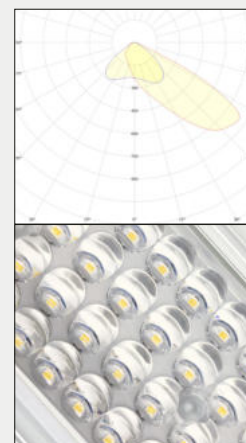

ON/OFF | Základní provedení vypnout/zapnout **DALI** | Digitálně strnivatelné provedení **AS** | Asymetrická optika / Tolerance světelného toku a příkonu svítidel $\pm 7,5\%$

ZAKÁZKOVÉ PŘÍKONY

830, 850, 860 (865)

na vyžádání lze dodat provedení s teplotou chromatičnosti 3000K, 5000K, 6000K (6500K)

EM1

nouzový záložní zdroj pro nouzové osvětlení, operační čas 1 hodina

EM1AT

nouzový záložní zdroj pro nouzové osvětlení, AUTOTEST, operační čas 1 hodina

