

# Bolero OL7

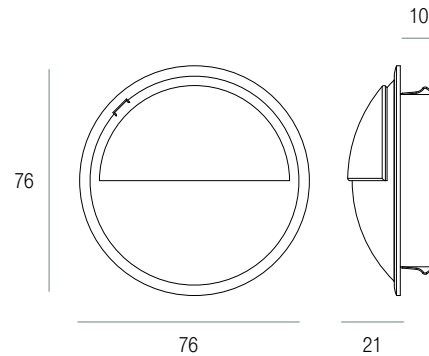

## Specifications • Parametry techniczne • Technische Parameter



Model	INDEX	Power (W)	Light source	CCT	lm	lm/W	IP	Weight (KG)
OL-OL7-I-W-1-PL-00-01	I	1,8 W	W	6000 K	54	30	20	-
OL-OL7-I-H-1-PL-00-01	I	1,8 W	WW	3800 K	49	27	20	-
OL-OL7-G-W-1-PL-00-01	G	1,8 W	W	6000 K	54	30	20	-
OL-OL7-G-H-1-PL-00-01	G	1,8 W	WW	3800 K	49	27	20	-
OL-OL7-D-W-1-PL-00-01	D	1,8 W	W	6000 K	54	30	20	-
OL-OL7-D-H-1-PL-00-01	D	1,8 W	WW	3800 K	49	27	20	-

### Use

For illumination of circulation routes, stairs, stair risers, cabinet fronts, or for attractive light decoration of walls.

### Zastosowanie

Do oświetlenia ciągów komunikacyjnych, schodów, podstopnic, witryn meblowych, lub do efektownego dekorowanie światłem ścian.

### Verwendung

Für die Beleuchtung der Verkehrsstränge, Treppen, Setzstufen, Vitrinen oder für eine effektvolle dekorative Wandbeleuchtung.

### Further information

**Material:** aluminium  
**Light source:** non-exchangeable LED modules  
**Method of installation:** back box Ø 60 mm  
**Warranty:** 36 months

### Informacje dodatkowe

**Material:** aluminium  
**Źródło światła:** niewymienialne moduły LED  
**Sposób montażu:** w puszcze Ø 60 mm  
**Gwarancja:** 36 miesięcy

### Zusätzliche Angaben

**Material:** Aluminium  
**Leuchtmittel:** in einer Installationsdose Ø 60 mm  
**Garantie:** 36 Monate

### Finishing • Wykończenie • Verarbeitungsart



### Colour of light • Barwa światła • Lichtfarbe



### Photometry • Fotometria • Photometrie

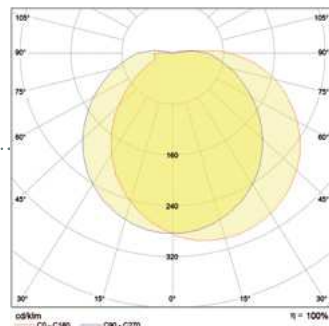

### Standards • Normy • Normen

PN-EN 60598-1:2015-04, PN-EN 62031:2010/A2:2015-04,  
 PN-EN 60598-2:2012, PN-EN 62031:2010/A1:2013-06  
 PN-EN 62471:2010,  
 PN-EN 62031:2010,

### Energy efficiency class • Klasa energetyczna • Energieklasse:





# Legend

Objaśnienia znaków • Legende

## Installation • Montaż • Montage



Cabinet mounted lighting with wide beam angle  
Oświetlenie meblowe do zabudowy z szerokim kątem świecenia  
Beleuchtung mit breitem Lichtwinkel für die Einbaumöbel



Cabinet mounted lighting with narrow beam angle  
Oświetlenie meblowe do zabudowy z wąskim kątem świecenia  
Beleuchtung mit schmalem Lichtwinkel für die Einbaumöbel



Cabinet top-mounted lighting with wide beam angle  
Oświetlenie meblowe do nadbudowy z szerokim kątem świecenia  
Beleuchtung mit breitem Lichtwinkel für die Aufbaumöbel



Overhead furniture lights  
Oświetlenie meblowe do nadbudowy z wąskim kątem świecenia  
Beleuchtung mit schmalem Lichtwinkel für die Aufbaumöbel



Furniture lights mounted on glazing  
Oświetlenie meblowe do montażu na szybie  
Furniture lights mounted on glazing



Built-in wide angle lights  
Oświetlenie sufitowe do zabudowy z szerokim kątem świecenia  
Einbauleuchten mit weitem Lichtwinkel



Overhead wide angle lights  
Oświetlenie sufitowe do nadbudowy z szerokim kątem świecenia  
Aufbauleuchten mit weitem Lichtwinkel



Wall-mounted wide angle lights  
Oświetlenie ścienne z szerokim kątem świecenia  
Wandleuchten mit weitem Lichtwinkel



Hanging wide angle lights  
Oświetlenie sufitowe wiszące z szerokim kątem świecenia  
Hängeleuchten mit weitem Lichtwinkel



Floor lighting with wide beam angle  
Oświetlenie podłogowe z szerokim kątem świecenia  
Bodenbeleuchtung mit breitem Lichtwinkel

## Finishing • Wykończenie • Verarbeitungsart



Surface Finishing  
Wykończenie powierzchni  
Oberflächenverarbeitung



stainless steel (INOX)  
Stal nierdzewna (INOX)  
Edelstahl (INOX)



Chrome plating  
Chrom  
Chrom



White  
Biały  
Weiß



Black  
Czarny  
Schwarz



Aged brass  
Mosiądz starzony  
Altmessing



Aluminium  
Aluminium  
Aluminium



Brushed nickel (INOX)  
Szczotkowany nikiel (INOX)  
Nickel gebürstet (INOX)



Brushed stainless steel (INOX)  
Szczotkowana stal nierdzewna (INOX)  
Edelstahl gebürstet (INOX)



Mirror (INOX)  
Lustro (INOX)  
Spiegelblank (INOX)



Matte brass  
Mosiądz mat  
Messing matt



Champagne  
Szampański  
Champagne



Transparent  
Przezroczysty  
Transparent

## Light specifications • Parametry świetlne

### Licht-Spezifikationen



LED Light source  
Źródło światła LED  
LED-Leuchtmittel



Replaceable Light source  
Wymienne źródło światła  
Austauschbares Leuchtmittel



Colour of light  
Barwa światła  
Lichtfarbe



Blue  
Niebieski  
Blau



Neutral  
Neutralny  
Neutral



Kaltweiß  
Zimny biały  
cool white



White warm  
Ciepły biały  
Warmweiß



Colour rendering index  
Współczynnik oddawania barw  
Farbwiedergabeindex



Colour temperature  
Temperatura barwowa  
Farbtemperatur



The upper limit temperature of white colour  
Górna granica temperatury koloru białego  
Die obere Grenztemperatur der weißen Farbe



The lower limit temperature of white colour  
Dolna granica temperatury koloru białego  
Die untere Grenztemperatur der weißen Farbe



LED light flux  
Strumień świetlny diody LED  
LED-Lichtstrom





























Luminaire light flux  
Strumień świetlny oprawy  
Lichtstrom der Leuchte



Luminous efficacy luminaire  
Skuteczność świetlna oprawy  
Lichtausbeute der Leuchte

## Specifications • Parametry techniczne

### Technische Parameter

	Rated power Moc znamionowa Nennleistung		Min. operating temperature Minimalna temperatura pracy Minimale Betriebstemperatur
	LED power Moc diody LED LED-Leistung		Max. operating temperature Maksymalna temperatura pracy Maximale Betriebstemperatur
	Fixture power Moc oprawy Leistung der Leuchte		Constant current Stabilizacja prądowa (Constant Current) Stromstabilisierung (Constant Current)
	DC voltage Wartość napięcia prądu stałego Spannung Konstantstrom		Constant voltage Stabilizacja napięciowa (Constant Voltage) Spannungstabilisierung (Constant Voltage)
	AC voltage Wartość napięcia prądu zmiennego Spannung Wechselstrom		PF (Power Factor) Wartość PF (Power Factor) PF-Wert (Power Factor)
	Energy efficiency class - LED Klasa efektywności energetycznej LED LED-Energieeffizienzklasse		Input voltage Napięcie wejściowe Eingangsspannung
	Energy efficiency class - replaceable light sources Klasa efektywności energetycznej - wymienne źródła światła Energieeffizienzklasse - austauschbare Leuchtmittel		Output voltage Napięcie wyjściowe Ausgangsspannung
	Tightness Szczelność Dichtheit		
	Resistance Wytrzymałość Beständigkeit		
	Protection class I I klasa ochronności Schutzklasse I		
	Protection class II II klasa ochronności Schutzklasse II		
	Protection class III III klasa ochronności Schutzklasse III		
	Device independent of lamps Urządzenie niezależne od lamp Gerät unabhängig von Leuchten		
	Short-circuit and overload proof safety transformer Transformator bezpieczeństwa odporny na zwarcia i przeciążenia. Sicherheitstransformator geschützt gegen Kurzschluss und Überlastung.		
	SELV protection Ochrona SELV Schutzkleinspannung SELV		
	Beam angle Kąt świecenia Lichtwinkel		
	Min. distance from illuminated item Min. odległość od oświetlanego obiektu Mindestabstand zum beleuchteten Objekt		
	Weight Waga Gewicht		
	Single LED tape module dimensions Wymiar pojedynczego modułu taśmy LED Abmessungen des Einzelmoduls eines LED-Streifens		

## Performance parameters • Parametry użytkowe

### Performance-Parameter

	Compatibility with SKOFF &More System Kompatybilność z systemem SKOFF &More Kompatibilität mit dem SKOFF & More System
	Compatibility with intelligent home systems Kompatybilność z systemami inteligentnego domu Kompatibel mit Smart-Home-Systemen
	Compatibility with DALI light controlling system Kompatybilność z systemami sterowania DALI Kompatibilität mit DALI Lichtregelsystem
	Dimming options Możliwość ściemniania Steuerung der Helligkeit
	No dimming Brak możliwości ściemniania Keine Steuerung der Helligkeit
	Możliwość zmiany barwy koloru emitowanego światła Emitting light colour change available Ausstrahlende helle Farbenänderung vorhanden
	Brak możliwości zmiany barwy koloru emitowanego światła Emitting light colour change not available Lichtausstritt ist nicht möglich
	Low glare index Niski współczynnik ośnienia Niedriger Blendungsindex
	Compliance with RoHS Zgodność z wymaganiami RoHS Entspricht den RoHS-Richtlinien
	Compliance with CE Directive Zgodność z dyrektywą CE Entspricht der CE-Richtlinie
	Compliance with WEEE Directive Zgodność z dyrektywą WEEE Entspricht der WEEE-Richtlinie
	Compliance with cRUus requirements Zgodność z wymaganiami cRUus Entspricht den cRUus-Anforderungen
	SKOFF item no. Numer indeksu SKOFF SKOFF Index-Nr.
	3M technology is implemented in the product W produkcji zastosowano technologię firmy 3M Im Produkt wurde die Technologie vom 3M-Konzern eingesetzt

© SKOFF 2017

We protect our Intellectual Property Rights • Chronimy nasze prawa własności intelektualnej • Wir schützen unsere Rechte am geistigen Eigentum.

We reserve our rights for technical modifications • Zastrzegamy sobie prawo do wprowadzania zmian technicznych • Technische Änderungen vorbehalten.