

L1B-N Kabelový žlab LINEAR+, neperforovaný

H35/ L = 3 000mm

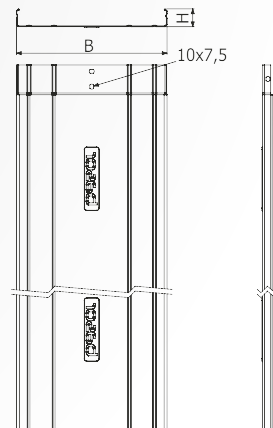

Pro spoj žlabů použijte **SSB M6 - 4ks**



označení	B [mm]	H [mm]	objednací kód		max. zátěž při rozteči kotvení				využitelnost při max. zátěži			
			SZ	A2/A4	1,5 m	2,0 m	2,5 m	3,0 m	1,5 m	2,0 m	2,5 m	3,0 m
L1B-N 100/35	100	35	ARB-14118205		70 kg/m	35 kg/m	15 kg/m	8 kg/m	100 %			
L1B-N 150/35	150		ARB-14118405						100 %		58 %	
L1B-N 200/35	200		ARB-14118505						100 %	81 %	44 %	
L1B-N 300/35	300		ARB-14118706						100 %	54 %	29 %	

H50/ L = 3 000mm

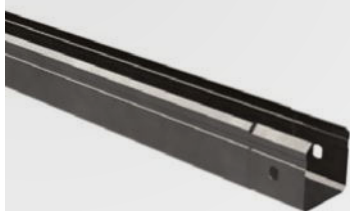

Pro spoj žlabů použijte **SSB M6 - 3ks**

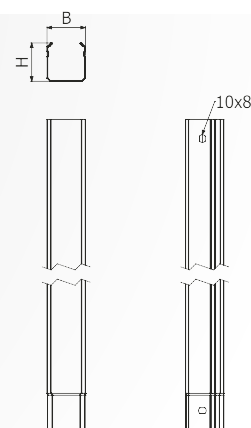

označení	B [mm]	H [mm]	objednací kód			max. zátěž při rozteči kotvení				využitelnost při max. zátěži				
			SZ	ZZ	A2/A4	1,5 m	2,0 m	2,5 m	3,0 m	1,5 m	2,0 m	2,5 m	3,0 m	
L1B-N 50/50	50	50	ARB-14120105	ARB-12120106		23 kg/m	13 kg/m	8 kg/m	5 kg/m	100 %				76 %

H60/ L = 3 000mm



Pro spoj žlabů
použijte **SSB M6 - 4ks**

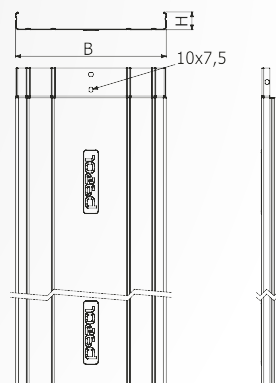

označení	B [mm]	H [mm]	objednací kód			max. zátěž při rozteči kotvení				využitelnost při max. zátěži			
			SZ	ZZ	A2/A4	1,5 m	2,0 m	2,5 m	3,0 m	1,5 m	2,0 m	2,5 m	3,0 m
L1B-N 100/60	100	60	ARB-14121705	ARB-12121706	☎	130 kg/m	85 kg/m	55 kg/m	25 kg/m	100 %			
L1B-N 150/60	150		ARB-14121905	ARB-12121906						100 %			
L1B-N 200/60	200		ARB-14122006	ARB-12122007						100 %	82 %		
L1B-N 300/60	300		ARB-14122207	ARB-12122207						100 %		54 %	
L1B-N 400/60	400		ARB-14122308	ARB-12122308						100 %	96 %	48 %	
L1B-N 500/60	500		ARB-14122408	ARB-12122408						100 %	77 %	38 %	

H100/ L = 3 000mm



*

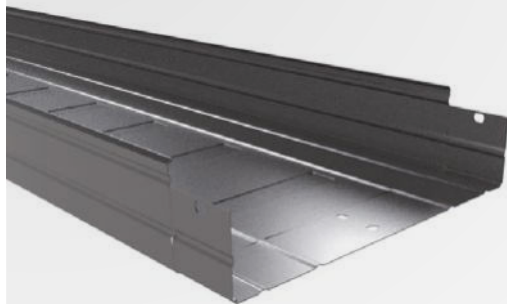

Pro spoj žlabů
použijte **SSB M6 - 4ks**

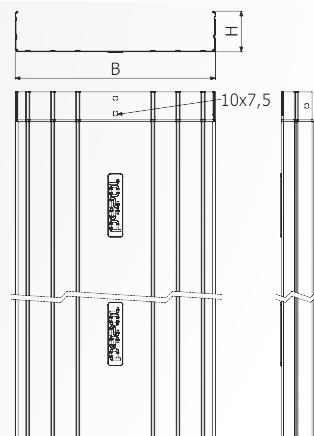

označení	B [mm]	H [mm]	objednací kód			max. zátěž při rozteči kotvení				využitelnost při max. zátěži			
			SZ	ZZ	A2/A4	1,5 m	2,0 m	2,5 m	3,0 m	1,5 m	2,0 m	2,5 m	3,0 m
L1B-N 100/100	100	100	ARB-14124605	ARB-12124606	☎	125 kg/m	80 kg/m	45 kg/m	20 kg/m	100 %			
L1B-N 150/100	150		ARB-14124805	ARB-12124806						100 %	87 %	38 %	
L1B-N 200/100	200		ARB-14124906	ARB-12124907						100 %	65 %	29 %	
L1B-N 300/100	300		ARB-14125107	ARB-12125108						100 %	77 %	43 %	19 %
L1B-N 400/100	400		ARB-14125208	ARB-12125208						100 %	68 %	40 %	22 %
L1B-N 500/100	500		ARB-14125308	ARB-12125308						84 %	54 %	32 %	18 %

* K datu 1. 11. 2023 jsou na požární odolnost otestovány žlaby šířky 300, 400 a 500 mm.

PŘÍSLUŠENSTVÍ ŽLABŮ LINEAR+



SL-1B 35 str. 26



SL-1B 100 str. 26



SKL-1B str. 26



STL-1B str. 26

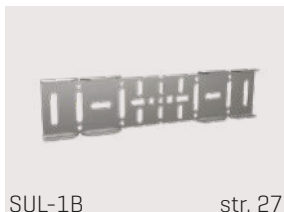

SUL-1B str. 27



SVL-1B str. 27



SVZ-B str. 27



KL-1B str. 28



TL-1B str. 28



KSL-1B str. 29



KKL-1B str. 29



TLL-1B str. 30

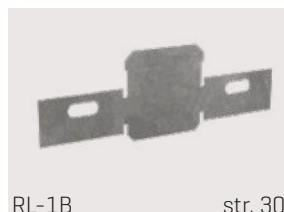

RL-1B str. 30



DNFI-B str. 31



DSL-1B str. 31



DNL-B str. 31

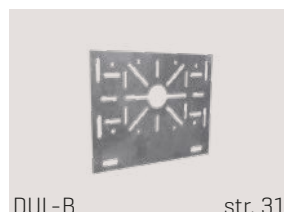

DUL-B str. 31



NS-B str. 32



DNU-B str. 32



NR-B str. 32



PTU-B str. 32



NCL-B str. 33

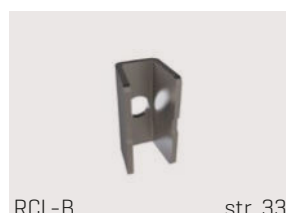

RCL-B str. 33



PL-B str. 33



OLL-B str. 33

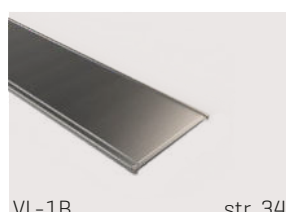

VL-1B str. 34



KPL-B str. 34



VKL-1B str. 34

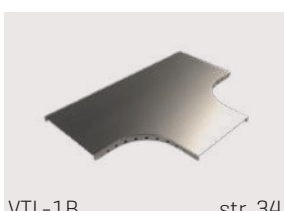

VTL-1B str. 34



VKSL-1B str. 35



VKKL-1B str. 35

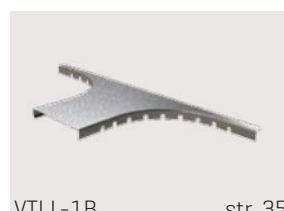

VTLL-1B str. 35

