

S2-S2

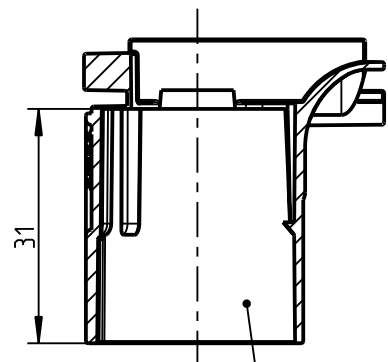

Aufnahme fuer
Kunststoff-Wellrohr
nach DIN EN 61386-1 / -22
Aussendurchmesser 25mm

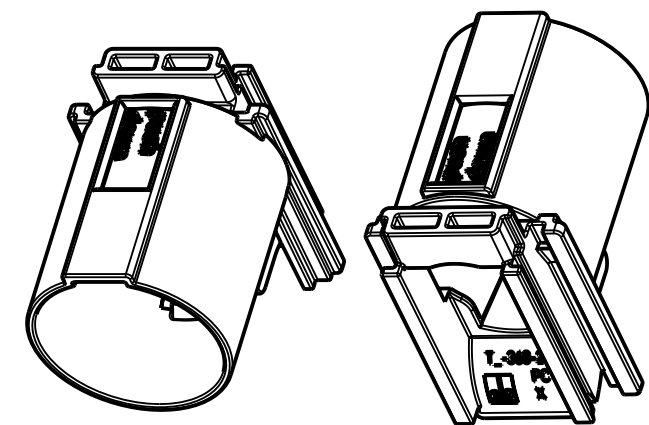
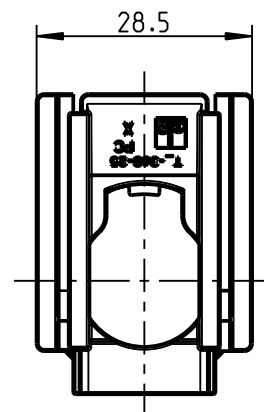
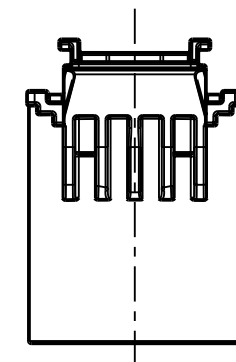
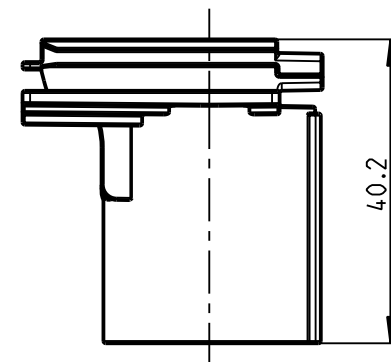
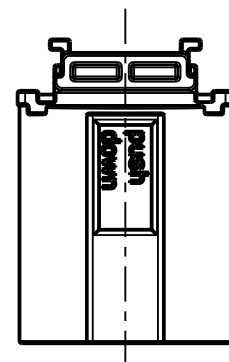

Geeignet fuer
Precon P71 GRD- / GVD-Typen!

Schutzvermerk ISO 16016 beachten. Refer to protection notice ISO 16016. Maßstab: 1:1

	Massblatt P 71 RA 25 M-984-025-01	
	0 Freigabe 03.05.17	