

Datový list | Objednací číslo: 788-304/003-000

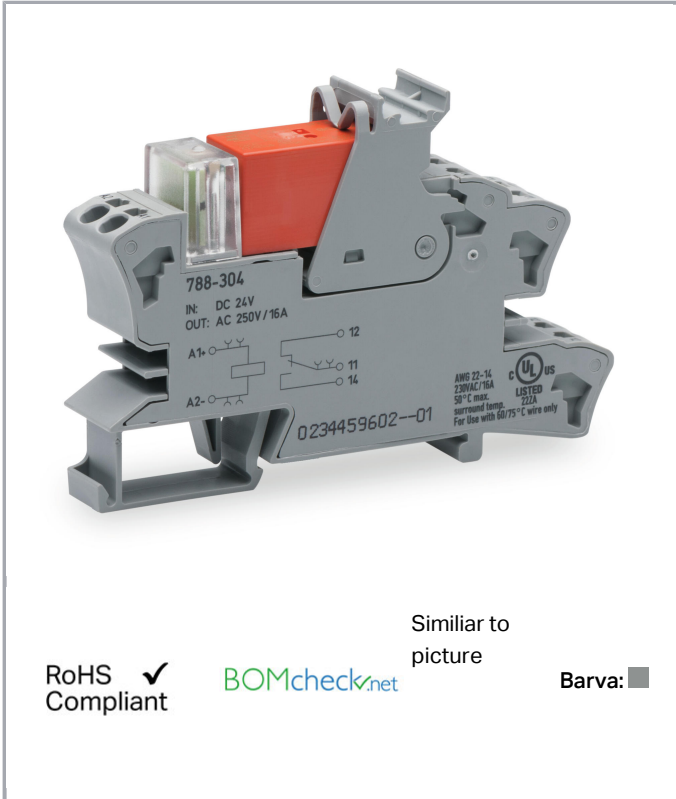

Reléový modul; Vstupní jmenovité napětí DC 24 V; 1 přepínací kontakt; Mezní trvalý proud 16 A; Indikace stavu červená; Konstrukční šířka 15 mm; 2,50 mm²; Šedá

www.wago.com/788-304/003-000



Similar to picture

RoHS Compliant ✓

[BOMcheck.net](https://www.bomcheck.net)

Barva: ■

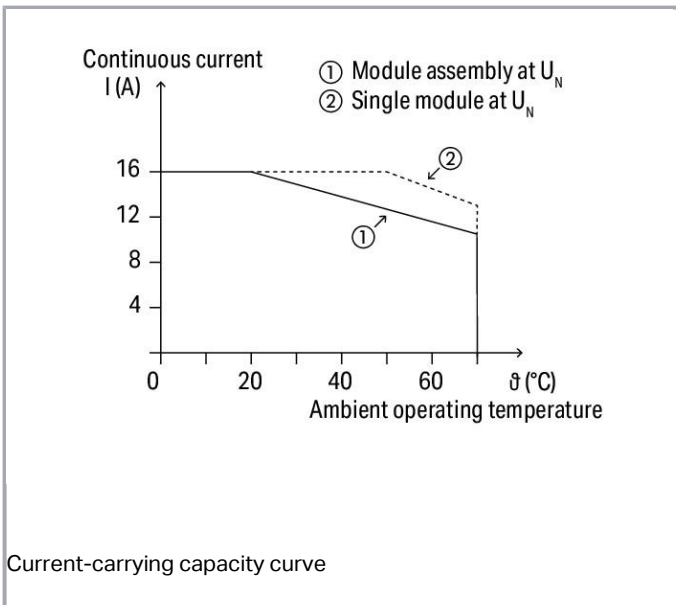
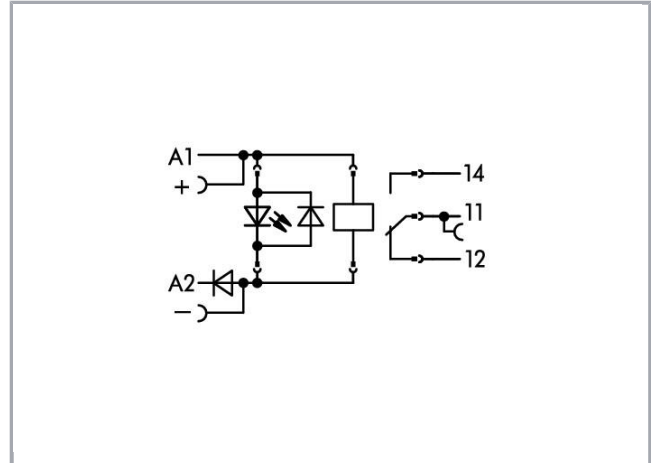

Current-carrying capacity curve

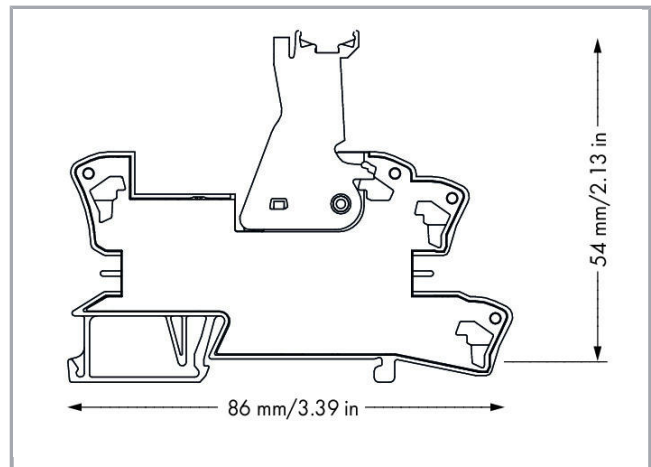

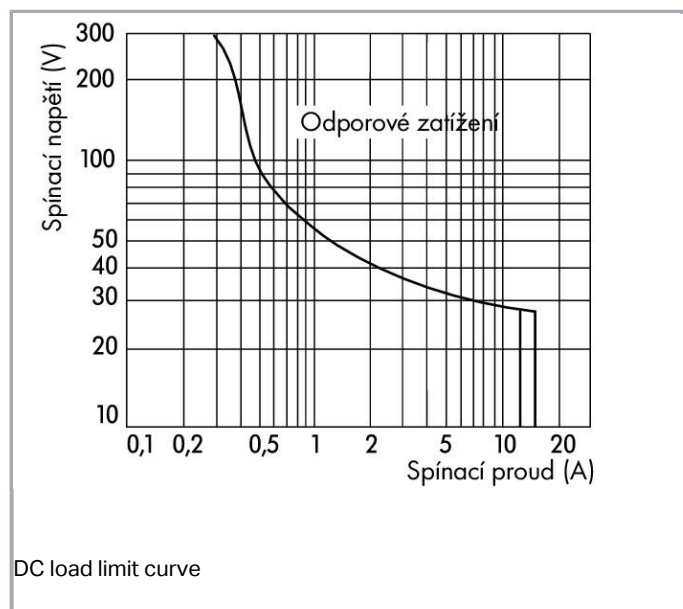

Popis položky

Upozornění:

- Reinforced insulation between coil and contacts
- A separator plate (e.g., 209-191) must be used for voltages greater than 250 V between adjacent relay modules and for compliance with the reinforced insulation requirements.
- To protect the relay coils and contacts, inductive loads must be dampened with an effective protection circuit.

Data

Technické údaje

Řídicí obvod:

Nominal input voltage U_N	DC 24 V
Input voltage range	-25 ... +30 %
Jmenovitý vstupní proud I_N	19 mA

Zátěžový obvod:

Počet přepínacích kontaktů	1
Contact material (relay)	AgNi 90/10
Limiting continuous current	16 A
Max. make current (resistive)	(AC) 30 A / 4 s
Max. switching voltage	AC 250 V
Max. switching power (resistive)	AC 4000 VA; DC see load limit curve
Switching capacity	AC-15: 6 A / AC 250 V; DC-13: 2 A / DC 24 V



Doporučené minimální zatížení	12 V / 10 mA
Reakční doba typ.	8 ms
Doba odpadu	6 ms
doba odskakování (typ)	6 ms
Electrical life (N.O.; resistive load; 23 °C)	30 x 10 ³ switching operations
Mechanical life (N.O.; resistive load; 23 °C)	30 x 10 ⁶ switching operations
Max. switching load with load/without load	6 min ⁻¹ / 1200 min ⁻¹

Signaling

Indikace stavu	LED red
----------------	---------

Bezpečnost a ochrana:

Návrhové napětí	250 V
Návrhové rázové napětí	4 kV
Stupeň znečištění	3
Dielectric strength, control/load circuit (AC, 1 min)	5 kVrms
Dielectric strength open contact (AC, 1 min)	1 kVrms
Krytí	IP20

Geometrické údaje

Šířka	15 mm / 0.591 inch
Výška od horní hrany lišty DIN 35	54 mm / 2.126 inch
Hloubka	86 mm / 3.386 inch

Údaje o materiálu

barva	Šedá
-------	------

Okolní podmínky

Okolní teplota (skladování)	-40 ... 70 °C
Processing temperature	-25 ... +50 °C

Standardy a technické údaje



Normy/ustanovení	EN 61010-2-201; EN 61810-1; EN 61373; UL 508 (max. 10 A); DNV GL
------------------	--

Obchodní údaje

Druh balení	BOX
-------------	-----

Atesty/certifikáty

Atesty pro použití v loďním průmyslu

Logo	Schválení	Doplňkový text schválení	Název certifikátu
	DNV GL Det Norske Veritas, Germanischer Lloyd	-	TAA00001D1
	NK Nippon Kaiji Kyokai	-	TA17255M
	PRS Polski Rejestr Statków	-	TE/2186 /880590/18



Atesty UL

Logo	Schválení	Doplňkový text schválení	Název certifikátu
	UL UL International Netherlands B.V. (ORDINARY LOCATIONS)	UL 508	E175199 Sec.6









Kompatibilní produkty

















General accessories















	Obj. č.: 209-145 Nosič skupinového označení	www.wago.com/209-145
	Obj. č.: 209-184 Ochranný pásek; Transparentní	www.wago.com/209-184
	Obj. č.: 249-105 Nosič skupinového označení	www.wago.com/249-105
Jumper		
	Obj. č.: 788-113 Hřebenový můstek; 2x; Izolováno	www.wago.com/788-113
	Obj. č.: 788-114 Hřebenový můstek; 3x; Izolováno	www.wago.com/788-114















	Obj. č.: 788-115 Hřebenový můstek; 4×; Izolováno	www.wago.com/788-115
	Obj. č.: 788-116 Hřebenový můstek; 6×; Izolováno	www.wago.com/788-116
	Obj. č.: 788-117 Hřebenový můstek; 8×; Izolováno	www.wago.com/788-117
	Obj. č.: 788-118 Hřebenový můstek; 2× (1-3); Izolováno	www.wago.com/788-118
	Obj. č.: 859-402 Hřebenový můstek; 2×; Jmenovitý proud 18 A; Izolováno; Světle šedá	www.wago.com/859-402
	Obj. č.: 859-402/000-005 Hřebenový můstek; 2×; Jmenovitý proud 18 A; Izolováno; Červená	www.wago.com/859-402/000-005
	Obj. č.: 859-402/000-006 Hřebenový můstek; 2×; Jmenovitý proud 18 A; Izolováno; Modrá	www.wago.com/859-402/000-006
	Obj. č.: 859-402/000-029 Hřebenový můstek; 2×; Jmenovitý proud 18 A; Izolováno; Žlutá	www.wago.com/859-402/000-029















Marking accessories

	Obj. č.: 2009-110 Popisovací páska; Na cívce; Neflexibilní; Bez potisku; Možnost naklapnutí; Bílá	www.wago.com/2009-110
	Obj. č.: 2009-115 WMB Inline; Pro Smart Printer; Na cívce; Flexibilní, 5–5,2 mm; Bez potisku; Možnost naklapnutí; Bílá	www.wago.com/2009-115
	Obj. č.: 2009-115/000-002 WMB Inline; Pro Smart Printer; Na cívce; Flexibilní, 5–5,2 mm; Bez potisku; Možnost naklapnutí; Žlutá	www.wago.com/2009-115/000-002
	Obj. č.: 2009-115/000-006 WMB Inline; Pro Smart Printer; Na cívce; Flexibilní, 5–5,2 mm; Bez potisku; Možnost naklapnutí; Modrá	www.wago.com/2009-115/000-006
	Obj. č.: 2009-115/000-007 WMB Inline; Pro Smart Printer; Na cívce; Flexibilní, 5–5,2 mm; Bez potisku; Možnost naklapnutí; Šedá	www.wago.com/2009-115/000-007
	Obj. č.: 2009-115/000-012 WMB Inline; Pro Smart Printer; Na cívce; Flexibilní, 5–5,2 mm; Bez potisku; Možnost naklapnutí; Oranžová	www.wago.com/2009-115/000-012
	Obj. č.: 2009-115/000-017 WMB Inline; Pro Smart Printer; Na cívce; Flexibilní, 5–5,2 mm; Bez potisku; Možnost naklapnutí; Světle zelená	www.wago.com/2009-115/000-017
	Obj. č.: 2009-115/000-023 WMB Inline; Pro Smart Printer; Na cívce; Flexibilní, 5–5,2 mm; Bez potisku; Možnost naklapnutí; Zelená	www.wago.com/2009-115/000-023

	Obj. č.: 209-128 Adaptér	www.wago.com/209-128
	Obj. č.: 209-183 Zásuvný štítek; Bílá	www.wago.com/209-183
	Obj. č.: 210-110 Popisovač	www.wago.com/210-110
	Obj. č.: 793-501 Popisovací karta WMB; Jako karta; Neflexibilní; Bez potisku; Možnost naklapnutí; Bílá	www.wago.com/793-501
	Obj. č.: 793-501/000-002 Popisovací karta WMB; Jako karta; Neflexibilní; Bez potisku; Možnost naklapnutí; Bílá	www.wago.com/793-501/000-002
	Obj. č.: 793-501/000-005 Popisovací karta WMB; Jako karta; Neflexibilní; Bez potisku; Možnost naklapnutí; Červená	www.wago.com/793-501/000-005
	Obj. č.: 793-501/000-006 Popisovací karta WMB; Jako karta; Neflexibilní; Bez potisku; Možnost naklapnutí; Modrá	www.wago.com/793-501/000-006
	Obj. č.: 793-501/000-007 Popisovací karta WMB; Jako karta; Neflexibilní; Bez potisku; Možnost naklapnutí; Šedá	www.wago.com/793-501/000-007
	Obj. č.: 793-501/000-012 Popisovací karta WMB; Jako karta; Neflexibilní; Bez potisku; Možnost naklapnutí; Oranžová	www.wago.com/793-501/000-012
	Obj. č.: 793-501/000-017 Popisovací karta WMB; Jako karta; Neflexibilní; Bez potisku; Možnost naklapnutí; Světle zelená	www.wago.com/793-501/000-017
	Obj. č.: 793-501/000-023 Popisovací karta WMB; Jako karta; Neflexibilní; Bez potisku; Možnost naklapnutí; Zelená	www.wago.com/793-501/000-023
	Obj. č.: 793-501/000-024 Popisovací karta WMB; Jako karta; Neflexibilní; Bez potisku; Možnost naklapnutí; Fialová	www.wago.com/793-501/000-024
	Obj. č.: 793-502 Popisovací karta WMB; Jako karta; S potiskem; 1–10 (10×); Neflexibilní; Potisk vodorovný; Možnost naklapnutí; Bílá	www.wago.com/793-502
	Obj. č.: 793-502/000-002 Popisovací karta WMB; Jako karta; S potiskem; 1–10 (10×); Neflexibilní; Potisk vodorovný; Možnost naklapnutí; Žlutá	www.wago.com/793-502/000-002
	Obj. č.: 793-502/000-005 Popisovací karta WMB; Jako karta; S potiskem; 1–10 (10×); Neflexibilní; Potisk vodorovný; Možnost naklapnutí; Červená	www.wago.com/793-502/000-005
	Obj. č.: 793-502/000-006 Popisovací karta WMB; Jako karta; S potiskem; 1–10 (10×); Neflexibilní; Potisk vodorovný; Možnost naklapnutí; Modrá	www.wago.com/793-502/000-006

	Obj. č.: 793-502/000-007 Popisovací karta WMB; Jako karta; S potiskem; 1–10 (10×); Neflexibilní; Potisk vodorovný; Možnost naklapnutí; Šedá	www.wago.com/793-502/000-007
	Obj. č.: 793-502/000-012 Popisovací karta WMB; Jako karta; S potiskem; 1–10 (10×); Neflexibilní; Potisk vodorovný; Možnost naklapnutí; Oranžová	www.wago.com/793-502/000-012
	Obj. č.: 793-502/000-017 Popisovací karta WMB; Jako karta; S potiskem; 1–10 (10×); Neflexibilní; Potisk vodorovný; Možnost naklapnutí; Světle zelená	www.wago.com/793-502/000-017
	Obj. č.: 793-502/000-023 Popisovací karta WMB; Jako karta; S potiskem; 1–10 (10×); Neflexibilní; Potisk vodorovný; Možnost naklapnutí; Zelená	www.wago.com/793-502/000-023
	Obj. č.: 793-502/000-024 Popisovací karta WMB; Jako karta; S potiskem; 1–10 (10×); Neflexibilní; Potisk vodorovný; Možnost naklapnutí; Fialová	www.wago.com/793-502/000-024
	Obj. č.: 793-503 Popisovací karta WMB; Jako karta; S potiskem; 11–20 (10×); Neflexibilní; Potisk vodorovný; Možnost naklapnutí; Bílá	www.wago.com/793-503
	Obj. č.: 793-503/000-002 Popisovací karta WMB; Jako karta; S potiskem; 11–20 (10×); Neflexibilní; Potisk vodorovný; Možnost naklapnutí; Žlutá	www.wago.com/793-503/000-002
	Obj. č.: 793-503/000-005 Popisovací karta WMB; Jako karta; S potiskem; 11–20 (10×); Neflexibilní; Potisk vodorovný; Možnost naklapnutí; Červená	www.wago.com/793-503/000-005
	Obj. č.: 793-503/000-006 Popisovací karta WMB; Jako karta; S potiskem; 11–20 (10×); Neflexibilní; Potisk vodorovný; Možnost naklapnutí; Modrá	www.wago.com/793-503/000-006
	Obj. č.: 793-503/000-007 Popisovací karta WMB; Jako karta; S potiskem; 11–20 (10×); Neflexibilní; Potisk vodorovný; Možnost naklapnutí; Šedá	www.wago.com/793-503/000-007
	Obj. č.: 793-503/000-012 Popisovací karta WMB; Jako karta; S potiskem; 11–20 (10×); Neflexibilní; Potisk vodorovný; Možnost naklapnutí; Oranžová	www.wago.com/793-503/000-012
	Obj. č.: 793-503/000-017 Popisovací karta WMB; Jako karta; S potiskem; 11–20 (10×); Neflexibilní; Potisk vodorovný; Možnost naklapnutí; Světle zelená	www.wago.com/793-503/000-017
	Obj. č.: 793-503/000-023 Popisovací karta WMB; Jako karta; S potiskem; 11–20 (10×); Neflexibilní; Potisk vodorovný; Možnost naklapnutí; Zelená	www.wago.com/793-503/000-023
	Obj. č.: 793-503/000-024 Popisovací karta WMB; Jako karta; S potiskem; 11–20 (10×); Neflexibilní; Potisk vodorovný; Možnost naklapnutí; Fialová	www.wago.com/793-503/000-024
	Obj. č.: 793-504 Popisovací karta WMB; Jako karta; S potiskem; 21–30 (10×); Neflexibilní; Potisk vodorovný; Možnost naklapnutí; Bílá	www.wago.com/793-504

	Obj. č.: 793-504/000-002 Popisovací karta WMB; Jako karta; S potiskem; 21–30 (10×); Neflexibilní; Potisk vodorovný; Možnost naklapnutí; Žlutá	www.wago.com/793-504/000-002
	Obj. č.: 793-504/000-005 Popisovací karta WMB; Jako karta; S potiskem; 21–30 (10×); Neflexibilní; Potisk vodorovný; Možnost naklapnutí; Červená	www.wago.com/793-504/000-005
	Obj. č.: 793-504/000-006 Popisovací karta WMB; Jako karta; S potiskem; 21–30 (10×); Neflexibilní; Potisk vodorovný; Možnost naklapnutí; Modrá	www.wago.com/793-504/000-006
	Obj. č.: 793-504/000-012 Popisovací karta WMB; Jako karta; S potiskem; 21–30 (10×); Neflexibilní; Potisk vodorovný; Možnost naklapnutí; Oranžová	www.wago.com/793-504/000-012
	Obj. č.: 793-504/000-017 Popisovací karta WMB; Jako karta; S potiskem; 21–30 (10×); Neflexibilní; Potisk vodorovný; Možnost naklapnutí; Světle zelená	www.wago.com/793-504/000-017
	Obj. č.: 793-504/000-023 Popisovací karta WMB; Jako karta; S potiskem; 21–30 (10×); Neflexibilní; Potisk vodorovný; Možnost naklapnutí; Zelená	www.wago.com/793-504/000-023
	Obj. č.: 793-505 Popisovací karta WMB; Jako karta; S potiskem; 31–40 (10×); Neflexibilní; Potisk vodorovný; Možnost naklapnutí; Bílá	www.wago.com/793-505
	Obj. č.: 793-505/000-005 Popisovací karta WMB; Jako karta; S potiskem; 31–40 (10×); Neflexibilní; Potisk vodorovný; Možnost naklapnutí; Červená	www.wago.com/793-505/000-005
	Obj. č.: 793-505/000-006 Popisovací karta WMB; Jako karta; S potiskem; 31–40 (10×); Neflexibilní; Potisk vodorovný; Možnost naklapnutí; Modrá	www.wago.com/793-505/000-006
	Obj. č.: 793-505/000-007 Popisovací karta WMB; Jako karta; S potiskem; 31–40 (10×); Neflexibilní; Potisk vodorovný; Možnost naklapnutí; Šedá	www.wago.com/793-505/000-007
	Obj. č.: 793-505/000-012 Popisovací karta WMB; Jako karta; S potiskem; 31–40 (10×); Neflexibilní; Potisk vodorovný; Možnost naklapnutí; Oranžová	www.wago.com/793-505/000-012
	Obj. č.: 793-506 Popisovací karta WMB; Jako karta; S potiskem; 41–50 (10×); Neflexibilní; Potisk vodorovný; Možnost naklapnutí; Bílá	www.wago.com/793-506
	Obj. č.: 793-506/000-005 Popisovací karta WMB; Jako karta; S potiskem; 41–50 (10×); Neflexibilní; Potisk vodorovný; Možnost naklapnutí; Červená	www.wago.com/793-506/000-005
	Obj. č.: 793-506/000-006 Popisovací karta WMB; Jako karta; S potiskem; 41–50 (10×); Neflexibilní; Potisk vodorovný; Možnost naklapnutí; Modrá	www.wago.com/793-506/000-006
	Obj. č.: 793-506/000-012 Popisovací karta WMB; Jako karta; S potiskem; 41–50 (10×); Neflexibilní; Potisk vodorovný; Možnost naklapnutí; Oranžová	www.wago.com/793-506/000-012

	Obj. č.: 793-506/000-017 Popisovací karta WMB; Jako karta; S potiskem; 41–50 (10×); Neflexibilní; Potisk vodorovný; Možnost naklapnutí; Světle zelená	www.wago.com/793-506/000-017
	Obj. č.: 793-5501 Popisovací karta WMB; Jako karta; Pro svorky o šířce 5–17,5 mm; Flexibilní, 5–5,2 mm; Bez potisku; Možnost naklapnutí; Bílá	www.wago.com/793-5501
	Obj. č.: 793-5501/000-002 Popisovací karta WMB; Jako karta; Pro svorky o šířce 5–17,5 mm; Flexibilní, 5–5,2 mm; Bez potisku; Možnost naklapnutí; Žlutá	www.wago.com/793-5501/000-002
	Obj. č.: 793-5501/000-005 Popisovací karta WMB; Jako karta; Flexibilní, 5–5,2 mm; Bez potisku; Možnost naklapnutí; Červená	www.wago.com/793-5501/000-005
	Obj. č.: 793-5501/000-006 Popisovací karta WMB; Jako karta; Flexibilní, 5–5,2 mm; Bez potisku; Možnost naklapnutí; Modrá	www.wago.com/793-5501/000-006
	Obj. č.: 793-5501/000-007 Popisovací karta WMB; Jako karta; Flexibilní, 5–5,2 mm; Bez potisku; Možnost naklapnutí; Šedá	www.wago.com/793-5501/000-007
	Obj. č.: 793-5501/000-012 Popisovací karta WMB; Jako karta; Flexibilní, 5–5,2 mm; Bez potisku; Možnost naklapnutí; Oranžová	www.wago.com/793-5501/000-012
	Obj. č.: 793-5501/000-014 WMB marking card; as card; stretchable 5 - 5.2 mm; plain; snap-on type; brown	www.wago.com/793-5501/000-014
	Obj. č.: 793-5501/000-017 Popisovací karta WMB; Jako karta; Flexibilní, 5–5,2 mm; Bez potisku; Možnost naklapnutí; Světle zelená	www.wago.com/793-5501/000-017
	Obj. č.: 793-5501/000-023 Popisovací karta WMB; Jako karta; Flexibilní, 5–5,2 mm; Bez potisku; Možnost naklapnutí; Zelená	www.wago.com/793-5501/000-023
	Obj. č.: 793-5501/000-024 Popisovací karta WMB; Jako karta; Flexibilní, 5–5,2 mm; Bez potisku; Možnost naklapnutí; Fialová	www.wago.com/793-5501/000-024
	Obj. č.: 793-566 Popisovací karta WMB; Jako karta; S potiskem; 1–50 (2×); Neflexibilní; Potisk vodorovný; Možnost naklapnutí; Bílá	www.wago.com/793-566
	Obj. č.: 793-566/000-002 Popisovací karta WMB; Jako karta; S potiskem; 1–50 (2×); Neflexibilní; Potisk vodorovný; Možnost naklapnutí; Žlutá	www.wago.com/793-566/000-002
	Obj. č.: 793-566/000-005 Popisovací karta WMB; Jako karta; S potiskem; 1–50 (2×); Neflexibilní; Potisk vodorovný; Možnost naklapnutí; Červená	www.wago.com/793-566/000-005
	Obj. č.: 793-566/000-006 Popisovací karta WMB; Jako karta; S potiskem; 1–50 (2×); Neflexibilní; Potisk vodorovný; Možnost naklapnutí; Modrá	www.wago.com/793-566/000-006



Obj. č.: 793-566/000-007

Popisovací karta WMB; Jako karta; S potiskem; 1–50 (2×); Neflexibilní; Potisk vodorovný; Možnost naklapnutí; Šedá

www.wago.com/793-566/000-007



Obj. č.: 793-566/000-012

Popisovací karta WMB; Jako karta; S potiskem; 1–50 (2×); Neflexibilní; Potisk vodorovný; Možnost naklapnutí; Oranžová

www.wago.com/793-566/000-012



Obj. č.: 793-566/000-017

Popisovací karta WMB; Jako karta; S potiskem; 1–50 (2×); Neflexibilní; Potisk vodorovný; Možnost naklapnutí; Světle zelená

www.wago.com/793-566/000-017



Obj. č.: 793-566/000-023

Popisovací karta WMB; Jako karta; S potiskem; 1–50 (2×); Neflexibilní; Potisk vodorovný; Možnost naklapnutí; Zelená

www.wago.com/793-566/000-023



Obj. č.: 793-566/000-024

Popisovací karta WMB; Jako karta; S potiskem; 1–50 (2×); Neflexibilní; Potisk vodorovný; Možnost naklapnutí; Fialová

www.wago.com/793-566/000-024

ferrule



Obj. č.: 216-241

Ferrule; Sleeve for 0.5 mm² / 20 AWG; insulated; electro-tin plated; electrolytic copper; gastight crimped; acc. to DIN 46228, Part 4/09.90; white

www.wago.com/216-241



Obj. č.: 216-242

Ferrule; Sleeve for 0.75 mm² / 18 AWG; insulated; electro-tin plated; electrolytic copper; gastight crimped; acc. to DIN 46228, Part 4/09.90; gray

www.wago.com/216-242



Obj. č.: 216-243

Dutinka; Objímka na 1 mm² / AWG 18; S plastovým límcem; Galvanicky pocínováno; Elektrolytická měď; Plynotěsně osazena; Dle DIN 46228, část 4/09.90; Červená

www.wago.com/216-243



Obj. č.: 216-244

Dutinka; Objímka na 1,5 mm² / AWG 16; S plastovým límcem; Galvanicky pocínováno; Elektrolytická měď; Plynotěsně osazena; Dle DIN 46228, část 4/09.90; Černá

www.wago.com/216-244



Obj. č.: 216-542

Dvojitá dutinka; Objímka na 2 × 1 mm² / AWG 2 × 18; Červená izolace; Délka 12 mm; Červená

www.wago.com/216-542

tools



Obj. č.: 210-720

Ovládací nástroj; Břit: 3,5 × 0,5 mm; S částečně izolovanou rukojetí

www.wago.com/210-720

Ke stažení

Documentation

Instruction Leaflet

Sockets with Elementary Relay/ SSR

V 1.0.0

pdf
2,4 MB

Stáhnout

Additional Information

Disposal; Electrical and electronic equipment, Packaging

V 1.0.0

pdf
265,8 kB

Stáhnout



CAD/CAE-Data

CAE data

WSCAD Universe 788-304/003-000

[Stáhnout](#)

Handling Instructions

Inserting a conductor

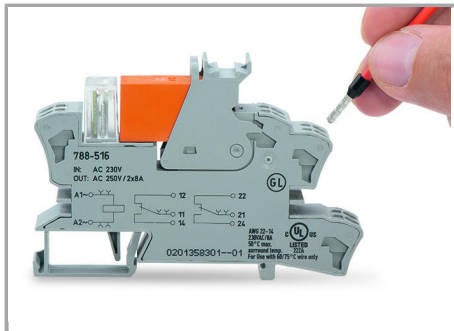

Leiter anschließen

Jumpered

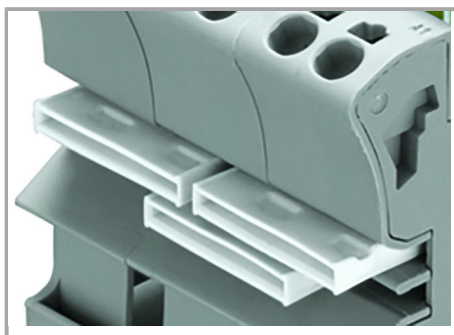

Easy commoning using adjacent jumpers

Marking

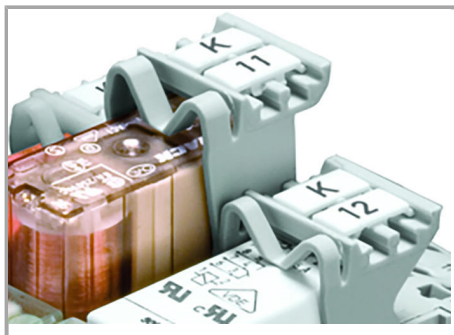

Marking using WMB Multi markers and group marker carriers

Změny vyhrazeny.