

Datový list | Objednací číslo: 787-1664/000-080

Elektronický jistič; 4kanál.; Vstupní napětí 24 V DC; Nastavitelný proud 1–10 A; IO-Link

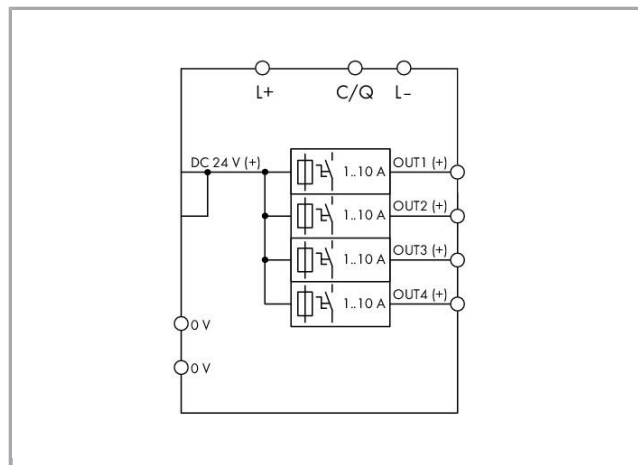

www.wago.com/787-1664/000-080



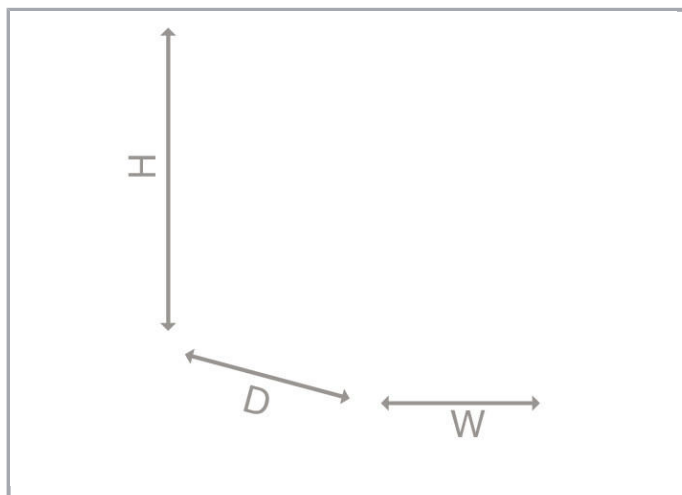

Popis položky

Features:

- Space-saving ECB with four channels
- Nominal current: 1 ... 10 A (adjustable for each channel via sealable selector switch or IO-Link interface)
- Switch-on capacity > 50,000 μ F per channel
- One illuminated, three-colored button per channel simplifies switching (on/off), resetting, and on-site diagnostics
- Time-delayed switching of channels
- Status message and current measurement of each individual channel via IO-Link interface
- Switch on/off each channel separately via IO-Link interface

Data

Technické údaje

Vstup

Nominal input voltage $U_{i \text{ nom}}$	DC 24 V
Input voltage range	DC 18 ... 30 V

Výstup

Celkový počet kanálů (modul)	4
Nominal output voltage $U_{o \text{ nom}}$	4 x DC 24 V
Output voltage range	DC 18 ... 30 V (U_i – voltage drop)
Voltage drop	≤ 200 mV (Input (+))
Nominal output current $I_{o \text{ nom}}$	4 x 1 / 2 / 3 / 4 / 6 / 8 / 10 A (adjustable for each channel seperately via IOlink interface; 1, 2, 4, 6, 10 A adjustable for each channel via selector switch)
Factory preset	DC 10 A; DC 2 A, vypnuto
Trip time	16 ms ... 100 s (Load-dependent)



Zapínací kapacita	> 50000 μ F Na každém kanálu
Spínací reakce	Zpožděné připojování kanálů (v závislosti na zatížení, min. 50 ms / max. 5 s)
Aktivní omezení proudu	ne

Signaling and communication

Signalizace	4× LED dioda (zelená/červená/oranžová) 1 x IOlink interface
Provozní indikace	LED green (channel OK) LED red (tripped channel)
Vzdálený vstup	Switching on/off any number of channels via IOlink interface

Účinnost / ztráta výkonu:

Power loss P_v	$\leq 0,84$ W (no load); ≤ 10 W (4 x 10 A)
Efficiency	99 %

Jištění:

Interní pojistka	15 A pomalé na každém kanálu
------------------	------------------------------

Bezpečnost a ochrana:

Insulation voltage (connectors-housing)	DC 0,5 kV
Třída ochrany	III
Krytí	IP20 (dle EN 60529)
Ochrana proti přepólování	Ne
Feedback voltage	\leq DC 35 V
Transient protection, primary	Suppressor diode, 33 V
Paralelní provoz jednotlivých kanálů	Není povoleno
Možnost sériového řazení	Ne
MTBF	> 500 000 hod. (dle IEC 61709)

Údaje o připojení

Typ připojení (1)	Input (+)
Připojovací technika	Push-in CAGE CLAMP®
WAGO terminal	WAGO 831 Series
Plný vodič	0,5 ... 10 mm ² / 20 ... 8 AWG
Jemně laněný vodič	0,5 ... 10 mm ² / 20 ... 8 AWG
Délka odizolování	13 ... 15 mm / 0.51 ... 0.59 palec
Typ připojení (2)	Input (-), output, signaling
Připojovací technika 2	CAGE CLAMP®



WAGO terminal 2	WAGO 721 Series
Plný vodič (2)	0,08 ... 2,5 mm ² / 28 ... 12 AWG
Jemně laněný vodič (2)	0,08 ... 2,5 mm ² / 28 ... 12 AWG
Délka odizolování (2)	8 ... 9 mm / 0.31 ... 0.35 palec

Geometrické údaje

Šířka	45 mm / 1.772 inch
Výška	90 mm / 3.543 inch
Length from upper-edge of DIN-35 rail	115,5 mm / 4.547 inch

Mechanické parametry

Způsob montáže	DIN-35 rail (EN 60715)
----------------	------------------------

Údaje o materiálu

Hmotnost	170
----------	-----

Okolní podmínky

Okolní teplota (provoz)	-25 ... 70 °C
Okolní teplota (skladování)	-25 ... 85 °C
Relative humidity	5 ... 96 % (no condensation permissible)
Pokles zatížitelnosti	≥ +50 °C: viz návod k použití
Stupeň znečištění	2

Standardy a technické údaje

Označení shody	CE
Normy/ustanovení	EN 60950; EN 61000-6-2; EN 61000-6-3; UL 508; UL 2367; DNV GL

Obchodní údaje















Druh balení	BOX
Country of origin	DE
GTIN	4055143899239
Customs Tariff No.	85363030888















Kompatibilní produkty**Marking accessories**

Obj. č.: 2009-110

Popisovací páska; Na cívice; Neflexibilní; Bez potisku; Možnost naklapnutí; Bílá

www.wago.com/2009-110

	Obj. č.: 2009-115 WMB Inline; Pro Smart Printer; Na cívce; Flexibilní, 5–5,2 mm; Bez potisku; Možnost naklapnutí; Bílá	www.wago.com/2009-115
	Obj. č.: 2009-115/000-002 WMB Inline; Pro Smart Printer; Na cívce; Flexibilní, 5–5,2 mm; Bez potisku; Možnost naklapnutí; Žlutá	www.wago.com/2009-115/000-002
	Obj. č.: 2009-115/000-006 WMB Inline; Pro Smart Printer; Na cívce; Flexibilní, 5–5,2 mm; Bez potisku; Možnost naklapnutí; Modrá	www.wago.com/2009-115/000-006
	Obj. č.: 2009-115/000-007 WMB Inline; Pro Smart Printer; Na cívce; Flexibilní, 5–5,2 mm; Bez potisku; Možnost naklapnutí; Šedá	www.wago.com/2009-115/000-007
	Obj. č.: 2009-115/000-012 WMB Inline; Pro Smart Printer; Na cívce; Flexibilní, 5–5,2 mm; Bez potisku; Možnost naklapnutí; Oranžová	www.wago.com/2009-115/000-012
	Obj. č.: 2009-115/000-017 WMB Inline; Pro Smart Printer; Na cívce; Flexibilní, 5–5,2 mm; Bez potisku; Možnost naklapnutí; Světle zelená	www.wago.com/2009-115/000-017
	Obj. č.: 2009-115/000-023 WMB Inline; Pro Smart Printer; Na cívce; Flexibilní, 5–5,2 mm; Bez potisku; Možnost naklapnutí; Zelená	www.wago.com/2009-115/000-023
	Obj. č.: 2009-115/000-024 WMB Inline; Pro Smart Printer; Na cívce; Flexibilní, 5–5,2 mm; Bez potisku; Možnost naklapnutí; Fialová	www.wago.com/2009-115/000-024
	Obj. č.: 2009-135 WMB-Inline; for Smart Printer; on reel; stretchable 5 - 5.2 mm; plain; snap-on type; white	www.wago.com/2009-135
	Obj. č.: 2009-145 Mini-WSB Inline; Pro Smart Printer; Na cívce; Flexibilní, 5–5,2 mm; Bez potisku; Možnost naklapnutí; Bílá	www.wago.com/2009-145
	Obj. č.: 2009-145/000-002 Mini-WSB Inline; Pro Smart Printer; Na cívce; Flexibilní, 5–5,2 mm; Bez potisku; Možnost naklapnutí; Žlutá	www.wago.com/2009-145/000-002
	Obj. č.: 2009-145/000-005 Mini-WSB Inline; Pro Smart Printer; Na cívce; Flexibilní, 5–5,2 mm; Bez potisku; Možnost naklapnutí; Červená	www.wago.com/2009-145/000-005
	Obj. č.: 2009-145/000-006 Mini-WSB Inline; Pro Smart Printer; Na cívce; Flexibilní, 5–5,2 mm; Bez potisku; Možnost naklapnutí; Modrá	www.wago.com/2009-145/000-006
	Obj. č.: 2009-145/000-007 Mini-WSB Inline; Pro Smart Printer; Na cívce; Flexibilní, 5–5,2 mm; Bez potisku; Možnost naklapnutí; Šedá	www.wago.com/2009-145/000-007
	Obj. č.: 2009-145/000-012 Mini-WSB Inline; Pro Smart Printer; Na cívce; Flexibilní, 5–5,2 mm; Bez potisku; Možnost naklapnutí; Oranžová	www.wago.com/2009-145/000-012
	Obj. č.: 2009-145/000-023	

	Mini-WSB Inline; Pro Smart Printer; Na cívce; Flexibilní, 5–5,2 mm; Bez potisku; Možnost naklapnutí; Zelená	www.wago.com/2009-145/000-023
	Obj. č.: 2009-145/000-024 Mini-WSB Inline; Pro Smart Printer; Na cívce; Flexibilní, 5–5,2 mm; Bez potisku; Možnost naklapnutí; Fialová	www.wago.com/2009-145/000-024
	Obj. č.: 210-831 Popisovací páska; Na cívce; Šířka 2,3 mm; Bez potisku; Samolepicí; Bílá	www.wago.com/210-831
	Obj. č.: 210-832 Popisovací páska; Na cívce; Šířka 3 mm; Bez potisku; Samolepicí; Bílá	www.wago.com/210-832
	Obj. č.: 248-501 Systém rychlého popisování Mini-WSB; Bez potisku; Šířka štítků 5 mm; 10 řad po 10 štítcích na každé kartě	www.wago.com/248-501
	Obj. č.: 248-501/000-002 Popisovací karta Mini-WSB; Jako karta; Neflexibilní; Bez potisku; Možnost naklapnutí; Žlutá	www.wago.com/248-501/000-002
	Obj. č.: 248-501/000-005 Popisovací karta Mini-WSB; Jako karta; Neflexibilní; Bez potisku; Možnost naklapnutí; Červená	www.wago.com/248-501/000-005
	Obj. č.: 248-501/000-006 Popisovací karta Mini-WSB; Jako karta; Neflexibilní; Bez potisku; Možnost naklapnutí; Modrá	www.wago.com/248-501/000-006
	Obj. č.: 248-501/000-007 Popisovací karta Mini-WSB; Jako karta; Neflexibilní; Bez potisku; Možnost naklapnutí; Šedá	www.wago.com/248-501/000-007
	Obj. č.: 248-501/000-012 Popisovací karta Mini-WSB; Jako karta; Neflexibilní; Bez potisku; Možnost naklapnutí; Oranžová	www.wago.com/248-501/000-012
	Obj. č.: 248-501/000-017 Popisovací karta Mini-WSB; Jako karta; Neflexibilní; Bez potisku; Možnost naklapnutí; Světle zelená	www.wago.com/248-501/000-017
	Obj. č.: 248-501/000-023 Popisovací karta Mini-WSB; Jako karta; Neflexibilní; Bez potisku; Možnost naklapnutí; Zelená	www.wago.com/248-501/000-023
	Obj. č.: 793-501 Popisovací karta WMB; Jako karta; Neflexibilní; Bez potisku; Možnost naklapnutí; Bílá	www.wago.com/793-501
	Obj. č.: 793-501/000-002 Popisovací karta WMB; Jako karta; Neflexibilní; Bez potisku; Možnost naklapnutí; Bílá	www.wago.com/793-501/000-002
	Obj. č.: 793-501/000-005 Popisovací karta WMB; Jako karta; Neflexibilní; Bez potisku; Možnost naklapnutí; Červená	www.wago.com/793-501/000-005



Obj. č.: 793-501/000-006

Popisovací karta WMB; Jako karta; Neflexibilní; Bez potisku; Možnost naklapnutí; Modrá

www.wago.com/793-501/000-006



Obj. č.: 793-501/000-007

Popisovací karta WMB; Jako karta; Neflexibilní; Bez potisku; Možnost naklapnutí; Šedá

www.wago.com/793-501/000-007



Obj. č.: 793-501/000-012

Popisovací karta WMB; Jako karta; Neflexibilní; Bez potisku; Možnost naklapnutí; Oranžová

www.wago.com/793-501/000-012



Obj. č.: 793-501/000-017

Popisovací karta WMB; Jako karta; Neflexibilní; Bez potisku; Možnost naklapnutí; Světle zelená

www.wago.com/793-501/000-017



Obj. č.: 793-501/000-023

Popisovací karta WMB; Jako karta; Neflexibilní; Bez potisku; Možnost naklapnutí; Zelená

www.wago.com/793-501/000-023



Obj. č.: 793-501/000-024

Popisovací karta WMB; Jako karta; Neflexibilní; Bez potisku; Možnost naklapnutí; Fialová

www.wago.com/793-501/000-024



Obj. č.: 793-5501

Popisovací karta WMB; Jako karta; Pro svorky o šířce 5–17,5 mm; Flexibilní, 5–5,2 mm; Bez potisku; Možnost naklapnutí; Bílá

www.wago.com/793-5501



Obj. č.: 793-5501/000-002

Popisovací karta WMB; Jako karta; Pro svorky o šířce 5–17,5 mm; Flexibilní, 5–5,2 mm; Bez potisku; Možnost naklapnutí; Žlutá

www.wago.com/793-5501/000-002



Obj. č.: 793-5501/000-005

Popisovací karta WMB; Jako karta; Flexibilní, 5–5,2 mm; Bez potisku; Možnost naklapnutí; Červená

www.wago.com/793-5501/000-005



Obj. č.: 793-5501/000-006

Popisovací karta WMB; Jako karta; Flexibilní, 5–5,2 mm; Bez potisku; Možnost naklapnutí; Modrá

www.wago.com/793-5501/000-006



Obj. č.: 793-5501/000-007

Popisovací karta WMB; Jako karta; Flexibilní, 5–5,2 mm; Bez potisku; Možnost naklapnutí; Šedá

www.wago.com/793-5501/000-007



Obj. č.: 793-5501/000-012

Popisovací karta WMB; Jako karta; Flexibilní, 5–5,2 mm; Bez potisku; Možnost naklapnutí; Oranžová

www.wago.com/793-5501/000-012



Obj. č.: 793-5501/000-014

WMB marking card; as card; stretchable 5 - 5.2 mm; plain; snap-on type; brown

www.wago.com/793-5501/000-014



Obj. č.: 793-5501/000-017

Popisovací karta WMB; Jako karta; Flexibilní, 5–5,2 mm; Bez potisku; Možnost naklapnutí; Světle zelená

www.wago.com/793-5501/000-017



Obj. č.: 793-5501/000-023















Popisovací karta WMB; Jako karta; Flexibilní, 5–5,2 mm; Bez potisku; Možnost naklapnutí; Zelená

www.wago.com/793-5501/000-023

**Obj. č.: 793-5501/000-024**

Popisovací karta WMB; Jako karta; Flexibilní, 5–5,2 mm; Bez potisku; Možnost naklapnutí; Fialová

www.wago.com/793-5501[/000-024](http://www.wago.com/793-5501/000-024)**ferrule****Obj. č.: 216-201**Ferrule; Sleeve for 0.5 mm² / 20 AWG; insulated; electro-tin plated; whitewww.wago.com/216-201**Obj. č.: 216-202**Ferrule; Sleeve for 0.75 mm² / 18 AWG; insulated; electro-tin plated; graywww.wago.com/216-202**Obj. č.: 216-203**Dutinka; Objímka na 1 mm² / AWG 18; S plastovým límcem; Galvanicky pocínováno; Červenáwww.wago.com/216-203**Obj. č.: 216-204**Dutinka; Objímka na 1,5 mm² / AWG 16; S plastovým límcem; Galvanicky pocínováno; Černáwww.wago.com/216-204**Obj. č.: 216-205**Dutinka; Objímka na 2,08 mm² / AWG 14; S plastovým límcem; Galvanicky pocínováno; Žlutáwww.wago.com/216-205**Obj. č.: 216-206**Dutinka; Objímka na 2,5 mm² / AWG 14; S plastovým límcem; Galvanicky pocínováno; Modráwww.wago.com/216-206**Obj. č.: 216-207**Dutinka; Objímka na 4 mm² / AWG 12; S plastovým límcem; Galvanicky pocínováno; Šedáwww.wago.com/216-207**Obj. č.: 216-208**Dutinka; Objímka na 6 mm² / AWG 10; S plastovým límcem; Galvanicky pocínováno; Elektrolytická měď; Plynotěsně osazena; Dle DIN 46228, část 4/09.90; Žlutáwww.wago.com/216-208**Obj. č.: 216-221**Ferrule; Sleeve for 0.5 mm² / 20 AWG; insulated; electro-tin plated; whitewww.wago.com/216-221**Obj. č.: 216-222**Ferrule; Sleeve for 0.75 mm² / 18 AWG; insulated; electro-tin plated; graywww.wago.com/216-222**Obj. č.: 216-223**Dutinka; Objímka na 1 mm² / AWG 18; S plastovým límcem; Galvanicky pocínováno; Červenáwww.wago.com/216-223**Obj. č.: 216-224**Dutinka; Objímka na 1,5 mm² / AWG 16; S plastovým límcem; Galvanicky pocínováno; Černáwww.wago.com/216-224**Obj. č.: 216-241**Ferrule; Sleeve for 0.5 mm² / 20 AWG; insulated; electro-tin plated; electrolytic copper; gastight crimped; acc. to DIN 46228, Part 4/09.90; whitewww.wago.com/216-241**Obj. č.: 216-242**Ferrule; Sleeve for 0.75 mm² / 18 AWG; insulated; electro-tin plated; electrolytic copper; gastight crimped; acc. to DIN 46228, Part 4/09.90; graywww.wago.com/216-242**Obj. č.: 216-243**Dutinka; Objímka na 1 mm² / AWG 18; S plastovým límcem; Galvanicky pocínováno; Elektrolytická měď; Plynotěsně osazena; Dle DIN 46228, část 4/09.90; Červenáwww.wago.com/216-243**Obj. č.: 216-244**Dutinka; Objímka na 1,5 mm² / AWG 16; S plastovým límcem; Galvanicky pocínováno; Elektrolytická měď; Plynotěsně osazena; Dle DIN 46228, část 4/09.90; Černáwww.wago.com/216-244**Obj. č.: 216-246**Dutinka; Objímka na 2,5 mm² / AWG 14; S plastovým límcem; Galvanicky pocínováno; Elektrolytická měď; Plynotěsně osazena; Dle DIN 46228, část 4/09.90; Modráwww.wago.com/216-246

	Obj. č.: 216-262 Ferrule; Sleeve for 0.75 mm ² / 18 AWG; insulated; electro-tin plated; electrolytic copper; gastight crimped; acc. to DIN 46228, Part 4/09.90; gray	www.wago.com/216-262
	Obj. č.: 216-263 Dutinka; Objímka na 1 mm ² / AWG 18; S plastovým límcem; Galvanicky pocínováno; Elektrolytická měď; Plynotěsně osazena; Dle DIN 46228, část 4/09.90; Červená	www.wago.com/216-263
	Obj. č.: 216-264 Dutinka; Objímka na 1,5 mm ² / AWG 16; S plastovým límcem; Galvanicky pocínováno; Elektrolytická měď; Plynotěsně osazena; Dle DIN 46228, část 4/09.90; Černá	www.wago.com/216-264
	Obj. č.: 216-266 Dutinka; Objímka na 2,5 mm ² / AWG 14; S plastovým límcem; Galvanicky pocínováno; Elektrolytická měď; Plynotěsně osazena; Dle DIN 46228, část 4/09.90; Modrá	www.wago.com/216-266
	Obj. č.: 216-267 Dutinka; Objímka na 4 mm ² / AWG 12; S plastovým límcem; Galvanicky pocínováno; Elektrolytická měď; Plynotěsně osazena; Dle DIN 46228, část 4/09.90; Šedá	www.wago.com/216-267
	Obj. č.: 216-284 Dutinka; Objímka na 1,5 mm ² / AWG 16; S plastovým límcem; Galvanicky pocínováno; Elektrolytická měď; Plynotěsně osazena; Dle DIN 46228, část 4/09.90; Černá	www.wago.com/216-284
	Obj. č.: 216-286 Dutinka; Objímka na 2,5 mm ² / AWG 14; S plastovým límcem; Galvanicky pocínováno; Elektrolytická měď; Plynotěsně osazena; Dle DIN 46228, část 4/09.90; Modrá	www.wago.com/216-286
	Obj. č.: 216-287 Dutinka; Objímka na 4 mm ² / AWG 12; S plastovým límcem; Galvanicky pocínováno; Elektrolytická měď; Plynotěsně osazena; Dle DIN 46228, část 4/09.90; Šedá	www.wago.com/216-287
	Obj. č.: 216-288 Dutinka; Objímka na 6 mm ² / AWG 10; S plastovým límcem; Galvanicky pocínováno; Elektrolytická měď; Plynotěsně osazena; Dle DIN 46228, část 4/09.90; Žlutá	www.wago.com/216-288
	Obj. č.: 216-301 Dutinka; Objímka na 0,25 mm ² / AWG 24; S plastovým límcem; Galvanicky pocínováno; Žlutá	www.wago.com/216-301
	Obj. č.: 216-302 Ferrule; Sleeve for 0.34 mm ² / 22 AWG; insulated; electro-tin plated; green	www.wago.com/216-302
	Obj. č.: 216-321 Dutinka; Objímka na 0,25 mm ² / AWG 24; S plastovým límcem; Galvanicky pocínováno; Žlutá	www.wago.com/216-321
	Obj. č.: 216-322 Ferrule; Sleeve for 0.34 mm ² / 22 AWG; insulated; electro-tin plated; green	www.wago.com/216-322
tools		
	Obj. č.: 210-720 Ovládací nástroj; Břit: 3,5 × 0,5 mm; S částečně izolovanou rukojetí	www.wago.com/210-720
	Obj. č.: 210-721 Ovládací nástroj; Břit: 5,5 × 0,8 mm; S částečně izolovanou rukojetí	www.wago.com/210-721
	Obj. č.: 210-769 Šroubovák; Zelená	www.wago.com/210-769

Ke stažení

Documentation

Manual



Electronic Circuit Breaker 24 VDC / 4 × 1... 0 A	V 1.1.1 10-Oct-2019	pdf 5,3 MB	Stáhnout
---	------------------------	---------------	----------

Additional Information

Disposal; Electrical and electronic equipment, Packaging	V 1.0.0	pdf 265,8 kB	Stáhnout
--	---------	-----------------	----------

Application Notes**Application note SIEMENS**

Application note Electronic fuse 787-166x/0000-0080 with I/O-Link Interface (a2019004)	2019-06-06 06-Jun-2019	zip 7,4 MB	Stáhnout
--	---------------------------	---------------	----------

This application note describes how the WAGO electronic fuses (787-1668 / 0000-0080 or 787-1664 / 0000-0080) with I/O-Link interface are integrated in the TIA Portal V15. The fuse is operated either on a Wago I/O-Link master or on a Siemens I/O-Link master.

Application note Electronic fuse 787-166x/0000-0080 with I/O-Link Interface (a2019005)	2019-06-06 06-Jun-2019	zip 11,0 MB	Stáhnout
--	---------------------------	----------------	----------

This Application Note explains how the WAGO electronic fuses (787-1668/0000-0080 and 787-1664/0000-0080) with I/O link interface are integrated into the SIMATIC Manager V5.5.

Application Note e!COCKPIT

e!COCKPIT application note WagoAppFuse (a2019001)	2019-09-17 17-Sep-2019	pdf 863,9 kB	Stáhnout
---	---------------------------	-----------------	----------

In this Application Note, an example project for the library "WagoAppFuse" is delivered. The electronic circuit breaker (ECB) is connected to an IO-Link master module 750-657.

Device Files**Device Description File**

Device description files 787-1664/000-080 for firmware until version 2.38	1.1 19-Mar-2018	zip 166,1 kB	Stáhnout
---	--------------------	-----------------	----------

Device description files 787-1664/000-080 for firmware version 2.39 and higher	1.4.1 10-Sep-2019	zip 166,3 kB	Stáhnout
--	----------------------	-----------------	----------

Handling Instructions



Změny vyhrazeny.

WAGO Elektro spol. sr. o.
Rozvodova 1116/36
143 00 Praha 12 - Modřany
Tel.: +420 261 090 143
Email: info.cz@wago.com, wago-cz@wago.com

Máte otázky ohledně našich produktů?
Kdykoli nám zavolejte na číslo +420 261 090 143.