

## Datový list | Objednací číslo: 769-611/006-000

1 vodičový konektor s pájecími piny; Zajišťovací příruba; 4 mm<sup>2</sup>; Rozteč 5 mm; 11pól.; 4,00 mm<sup>2</sup>; Šedá

[www.wago.com/769-611/006-000](http://www.wago.com/769-611/006-000)

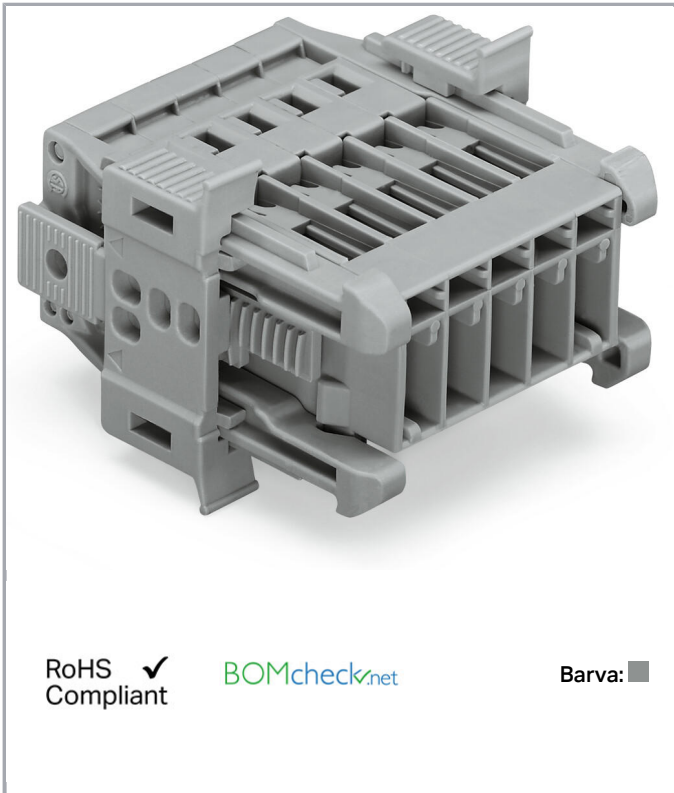

RoHS  Compliant

BOMcheck.net

Barva: ■

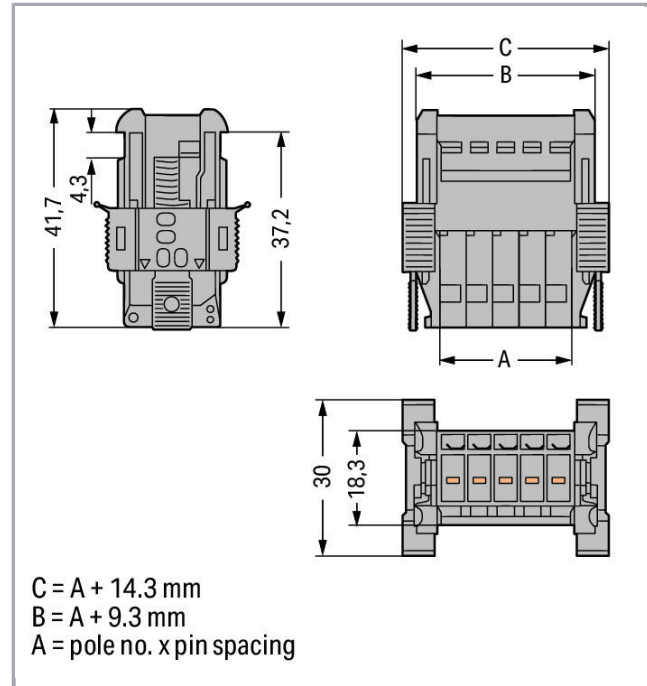

### Data

#### Elektrické parametry

#### Ratings per IEC/EN 60664-1

Návrhové napětí (III / 3)	500 V
Návrhové rázové napětí (III / 3)	6 kV
Jmenovitý proud	32 A
Legenda (návrhové hodnoty)	(III / 3) ≙ kategorie přepětí III / stupeň znečištění 3

#### Údaje o připojení

Připojovací technika	CAGE CLAMP®
Způsob ovládání	Ovládací nástroj
Materiály připojitelných vodičů	Měď
Jmenovitý průřez	4 mm <sup>2</sup>
Plný vodič	0,08 ... 4 mm <sup>2</sup> / 28 ... 12 AWG
Jemně laněný vodič	0,08 ... 4 mm <sup>2</sup> / 28 ... 12 AWG



Délka odizolování	8 ... 9 mm / 0.31 ... 0.35 palec
Počet pólů	11
Celkový počet kontaktních míst	11
Celkový počet potenciálů	11
Způsob zapojení	boční připojení

### Geometrické údaje

Rozteč	5 mm / 0.197 inch
Šířka	69,3 mm / 2.728 inch
Výška	30 mm / 1.181 inch
Hloubka	41,7 mm / 1.642 inch

### Mechanické parametry

Způsob upevnění	Snap-in
-----------------	---------

### Plug connection

Typ kontaktu (konektor)	Konektor (vidlice) / zástrčka
Typ připojení konektoru	pro vodiče

### Údaje o materiálu

barva	Šedá
Izolační materiál	Polyamid 66 (PA 66)
Požární zatížení	0.777 MJ
Hmotnost	36.882 g

### Obchodní údaje

Product Group	18 (X-COM-System)
Druh balení	BOX
Country of origin	PL
GTIN	4045454917098
Customs Tariff No.	85366990990

### Atesty/certifikáty

#### Specifické atesty jednotlivých států

Logo	Schválení	Doplňkový text schválení	Název certifikátu
	<b>CCA</b> DEKRA Certification B.V.	IEC 61984	NL-47799
	<b>CCA</b> DEKRA Certification B.V.	EN 61984	2190419.02





CSA  
DEKRA Certification B.V.

C22.2 No. 158





1101144















#### Atesty UL















Logo	Schválení	Doplňkový text schválení	Název certifikátu
	UR Underwriters Laboratories Inc.	UL 1059	31.07.2019- E45172
	UR Underwriters Laboratories Inc.	UL 1977	E45171- 20010720















#### Kompatibilní produkty

##### Female plug

	<b>Obj. č.: 769-101</b> 1 vodičová pružinová svorkovnice; 4 mm <sup>2</sup> ; 1pól.; 4,00 mm <sup>2</sup> ; Šedá	<a href="http://www.wago.com/769-101">www.wago.com/769-101</a>
	<b>Obj. č.: 769-101/000-016</b> 1 vodičová pružinová svorkovnice; 4 mm <sup>2</sup> ; 1pól.; 4,00 mm <sup>2</sup> ; Zeleno-žlutá	<a href="http://www.wago.com/769-101/000-016">www.wago.com/769-101/000-016</a>
	<b>Obj. č.: 769-102</b> 1 vodičová pružinová svorkovnice; 4 mm <sup>2</sup> ; 2pól.; 4,00 mm <sup>2</sup> ; Šedá	<a href="http://www.wago.com/769-102">www.wago.com/769-102</a>
	<b>Obj. č.: 769-102/000-036</b> 1 vodičová pružinová svorkovnice; 4 mm <sup>2</sup> ; 2pól.; 4,00 mm <sup>2</sup> ; Šedá / zelená – žlutá	<a href="http://www.wago.com/769-102/000-036">www.wago.com/769-102/000-036</a>
	<b>Obj. č.: 769-102/000-037</b> 1 vodičová pružinová svorkovnice; 4 mm <sup>2</sup> ; 2pól.; 4,00 mm <sup>2</sup> ; Zelená – žlutá / šedá	<a href="http://www.wago.com/769-102/000-037">www.wago.com/769-102/000-037</a>
	<b>Obj. č.: 769-103</b> 1 vodičová pružinová svorkovnice; 4 mm <sup>2</sup> ; 3pól.; 4,00 mm <sup>2</sup> ; Šedá	<a href="http://www.wago.com/769-103">www.wago.com/769-103</a>

	<b>Obj. č.: 769-103/000-036</b> 1 vodičová pružinová svorkovnice; 4 mm <sup>2</sup> ; 3pól.; 4,00 mm <sup>2</sup> ; Šedá / zelená – žlutá	<a href="http://www.wago.com/769-103/000-036">www.wago.com/769-103/000-036</a>
	<b>Obj. č.: 769-103/000-037</b> 1 vodičová pružinová svorkovnice; 4 mm <sup>2</sup> ; 3pól.; 4,00 mm <sup>2</sup> ; Zelená – žlutá / šedá	<a href="http://www.wago.com/769-103/000-037">www.wago.com/769-103/000-037</a>
	<b>Obj. č.: 769-103/000-038</b> 1 vodičová pružinová svorkovnice; 4 mm <sup>2</sup> ; 3pól.; 4,00 mm <sup>2</sup> ; Šedá / modrá / zelená – žlutá	<a href="http://www.wago.com/769-103/000-038">www.wago.com/769-103/000-038</a>
	<b>Obj. č.: 769-103/000-039</b> 1 vodičová pružinová svorkovnice; 4 mm <sup>2</sup> ; 3pól.; 4,00 mm <sup>2</sup> ; Zelená – žlutá, modrá, šedá	<a href="http://www.wago.com/769-103/000-039">www.wago.com/769-103/000-039</a>
	<b>Obj. č.: 769-104</b> 1 vodičová pružinová svorkovnice; 4 mm <sup>2</sup> ; 4pól.; 4,00 mm <sup>2</sup> ; Šedá	<a href="http://www.wago.com/769-104">www.wago.com/769-104</a>
	<b>Obj. č.: 769-104/000-036</b> 1 vodičová pružinová svorkovnice; 4 mm <sup>2</sup> ; 4pól.; 4,00 mm <sup>2</sup> ; Šedá / zelená – žlutá	<a href="http://www.wago.com/769-104/000-036">www.wago.com/769-104/000-036</a>
	<b>Obj. č.: 769-104/000-037</b> 1 vodičová pružinová svorkovnice; 4 mm <sup>2</sup> ; 4pól.; 4,00 mm <sup>2</sup> ; Zelená – žlutá / šedá	<a href="http://www.wago.com/769-104/000-037">www.wago.com/769-104/000-037</a>
	<b>Obj. č.: 769-104/000-038</b> 1 vodičová pružinová svorkovnice; 4 mm <sup>2</sup> ; 4pól.; 4,00 mm <sup>2</sup> ; Šedá / modrá / zelená – žlutá	<a href="http://www.wago.com/769-104/000-038">www.wago.com/769-104/000-038</a>
	<b>Obj. č.: 769-104/000-039</b> 1 vodičová pružinová svorkovnice; 4 mm <sup>2</sup> ; 4pól.; 4,00 mm <sup>2</sup> ; Zelená – žlutá, modrá, šedá	<a href="http://www.wago.com/769-104/000-039">www.wago.com/769-104/000-039</a>
	<b>Obj. č.: 769-105</b> 1 vodičová pružinová svorkovnice; 4 mm <sup>2</sup> ; 5pól.; 4,00 mm <sup>2</sup> ; Šedá	<a href="http://www.wago.com/769-105">www.wago.com/769-105</a>
	<b>Obj. č.: 769-105/000-036</b> 1 vodičová pružinová svorkovnice; 4 mm <sup>2</sup> ; 5pól.; 4,00 mm <sup>2</sup> ; Šedá / zelená – žlutá	<a href="http://www.wago.com/769-105/000-036">www.wago.com/769-105/000-036</a>
	<b>Obj. č.: 769-105/000-037</b> 1 vodičová pružinová svorkovnice; 4 mm <sup>2</sup> ; 5pól.; 4,00 mm <sup>2</sup> ; Zelená – žlutá / šedá	<a href="http://www.wago.com/769-105/000-037">www.wago.com/769-105/000-037</a>
	<b>Obj. č.: 769-105/000-038</b> 1 vodičová pružinová svorkovnice; 4 mm <sup>2</sup> ; 5pól.; 4,00 mm <sup>2</sup> ; Šedá / modrá / zelená – žlutá	<a href="http://www.wago.com/769-105/000-038">www.wago.com/769-105/000-038</a>
	<b>Obj. č.: 769-105/000-039</b> 1 vodičová pružinová svorkovnice; 4 mm <sup>2</sup> ; 5pól.; 4,00 mm <sup>2</sup> ; Zelená – žlutá, modrá, šedá	<a href="http://www.wago.com/769-105/000-039">www.wago.com/769-105/000-039</a>
	<b>Obj. č.: 769-106</b> 1 vodičová pružinová svorkovnice; 4 mm <sup>2</sup> ; 6pól.; 4,00 mm <sup>2</sup> ; Šedá	<a href="http://www.wago.com/769-106">www.wago.com/769-106</a>

	<b>Obj. č.: 769-106/000-006</b> 1 vodičová pružinová svorkovnice; 4 mm <sup>2</sup> ; 6pól.; 4,00 mm <sup>2</sup> ; Modrá	<a href="http://www.wago.com/769-106/000-006">www.wago.com/769-106/000-006</a>
	<b>Obj. č.: 769-106/000-036</b> 1 vodičová pružinová svorkovnice; 4 mm <sup>2</sup> ; 6pól.; 4,00 mm <sup>2</sup> ; Šedá / zelená – žlutá	<a href="http://www.wago.com/769-106/000-036">www.wago.com/769-106/000-036</a>
	<b>Obj. č.: 769-106/000-037</b> 1 vodičová pružinová svorkovnice; 4 mm <sup>2</sup> ; 6pól.; 4,00 mm <sup>2</sup> ; Zelená – žlutá / šedá	<a href="http://www.wago.com/769-106/000-037">www.wago.com/769-106/000-037</a>
	<b>Obj. č.: 769-106/000-038</b> 1 vodičová pružinová svorkovnice; 4 mm <sup>2</sup> ; 6pól.; 4,00 mm <sup>2</sup> ; Šedá / modrá / zelená – žlutá	<a href="http://www.wago.com/769-106/000-038">www.wago.com/769-106/000-038</a>
	<b>Obj. č.: 769-106/000-039</b> 1 vodičová pružinová svorkovnice; 4 mm <sup>2</sup> ; 6pól.; 4,00 mm <sup>2</sup> ; Zelená – žlutá, modrá, šedá	<a href="http://www.wago.com/769-106/000-039">www.wago.com/769-106/000-039</a>
	<b>Obj. č.: 769-107</b> 1 vodičová pružinová svorkovnice; 4 mm <sup>2</sup> ; 7pól.; 4,00 mm <sup>2</sup> ; Šedá	<a href="http://www.wago.com/769-107">www.wago.com/769-107</a>
	<b>Obj. č.: 769-107/000-036</b> 1 vodičová pružinová svorkovnice; 4 mm <sup>2</sup> ; 7pól.; 4,00 mm <sup>2</sup> ; Šedá / zelená – žlutá	<a href="http://www.wago.com/769-107/000-036">www.wago.com/769-107/000-036</a>
	<b>Obj. č.: 769-107/000-037</b> 1 vodičová pružinová svorkovnice; 4 mm <sup>2</sup> ; 7pól.; 4,00 mm <sup>2</sup> ; Zelená – žlutá / šedá	<a href="http://www.wago.com/769-107/000-037">www.wago.com/769-107/000-037</a>
	<b>Obj. č.: 769-107/000-038</b> 1 vodičová pružinová svorkovnice; 4 mm <sup>2</sup> ; 7pól.; 4,00 mm <sup>2</sup> ; Šedá / modrá / zelená – žlutá	<a href="http://www.wago.com/769-107/000-038">www.wago.com/769-107/000-038</a>
	<b>Obj. č.: 769-107/000-039</b> 1 vodičová pružinová svorkovnice; 4 mm <sup>2</sup> ; 7pól.; 4,00 mm <sup>2</sup> ; Zelená – žlutá, modrá, šedá	<a href="http://www.wago.com/769-107/000-039">www.wago.com/769-107/000-039</a>
	<b>Obj. č.: 769-108</b> 1 vodičová pružinová svorkovnice; 4 mm <sup>2</sup> ; 8pól.; 4,00 mm <sup>2</sup> ; Šedá	<a href="http://www.wago.com/769-108">www.wago.com/769-108</a>
	<b>Obj. č.: 769-108/000-036</b> 1 vodičová pružinová svorkovnice; 4 mm <sup>2</sup> ; 8pól.; 4,00 mm <sup>2</sup> ; Šedá / zelená – žlutá	<a href="http://www.wago.com/769-108/000-036">www.wago.com/769-108/000-036</a>
	<b>Obj. č.: 769-108/000-037</b> 1 vodičová pružinová svorkovnice; 4 mm <sup>2</sup> ; 8pól.; 4,00 mm <sup>2</sup> ; Zelená – žlutá / šedá	<a href="http://www.wago.com/769-108/000-037">www.wago.com/769-108/000-037</a>
	<b>Obj. č.: 769-108/000-038</b> 1 vodičová pružinová svorkovnice; 4 mm <sup>2</sup> ; 8pól.; 4,00 mm <sup>2</sup> ; Šedá / modrá / zelená – žlutá	<a href="http://www.wago.com/769-108/000-038">www.wago.com/769-108/000-038</a>
	<b>Obj. č.: 769-108/000-039</b> 1 vodičová pružinová svorkovnice; 4 mm <sup>2</sup> ; 8pól.; 4,00 mm <sup>2</sup> ; Zelená – žlutá, modrá, šedá	<a href="http://www.wago.com/769-108/000-039">www.wago.com/769-108/000-039</a>

	<b>Obj. č.: 769-109</b> 1 vodičová pružinová svorkovnice; 4 mm <sup>2</sup> ; 9pól.; 4,00 mm <sup>2</sup> ; Šedá	<a href="http://www.wago.com/769-109">www.wago.com/769-109</a>
	<b>Obj. č.: 769-109/000-036</b> 1 vodičová pružinová svorkovnice; 4 mm <sup>2</sup> ; 9pól.; 4,00 mm <sup>2</sup> ; Šedá / zelená – žlutá	<a href="http://www.wago.com/769-109/000-036">www.wago.com/769-109/000-036</a>
	<b>Obj. č.: 769-109/000-037</b> 1 vodičová pružinová svorkovnice; 4 mm <sup>2</sup> ; 9pól.; 4,00 mm <sup>2</sup> ; Zelená – žlutá / šedá	<a href="http://www.wago.com/769-109/000-037">www.wago.com/769-109/000-037</a>
	<b>Obj. č.: 769-109/000-038</b> 1 vodičová pružinová svorkovnice; 4 mm <sup>2</sup> ; 9pól.; 4,00 mm <sup>2</sup> ; Šedá / modrá / zelená – žlutá	<a href="http://www.wago.com/769-109/000-038">www.wago.com/769-109/000-038</a>
	<b>Obj. č.: 769-109/000-039</b> 1 vodičová pružinová svorkovnice; 4 mm <sup>2</sup> ; 9pól.; 4,00 mm <sup>2</sup> ; Zelená – žlutá, modrá, šedá	<a href="http://www.wago.com/769-109/000-039">www.wago.com/769-109/000-039</a>
	<b>Obj. č.: 769-110</b> 1 vodičová pružinová svorkovnice; 4 mm <sup>2</sup> ; 10pól.; 4,00 mm <sup>2</sup> ; Šedá	<a href="http://www.wago.com/769-110">www.wago.com/769-110</a>
	<b>Obj. č.: 769-110/000-036</b> 1 vodičová pružinová svorkovnice; 4 mm <sup>2</sup> ; 10pól.; 4,00 mm <sup>2</sup> ; Šedá / zelená – žlutá	<a href="http://www.wago.com/769-110/000-036">www.wago.com/769-110/000-036</a>
	<b>Obj. č.: 769-110/000-037</b> 1 vodičová pružinová svorkovnice; 4 mm <sup>2</sup> ; 10pól.; 4,00 mm <sup>2</sup> ; Zelená – žlutá / šedá	<a href="http://www.wago.com/769-110/000-037">www.wago.com/769-110/000-037</a>
	<b>Obj. č.: 769-110/000-038</b> 1 vodičová pružinová svorkovnice; 4 mm <sup>2</sup> ; 10pól.; 4,00 mm <sup>2</sup> ; Šedá / modrá / zelená – žlutá	<a href="http://www.wago.com/769-110/000-038">www.wago.com/769-110/000-038</a>
	<b>Obj. č.: 769-110/000-039</b> 1 vodičová pružinová svorkovnice; 4 mm <sup>2</sup> ; 10pól.; 4,00 mm <sup>2</sup> ; Zelená – žlutá, modrá, šedá	<a href="http://www.wago.com/769-110/000-039">www.wago.com/769-110/000-039</a>
	<b>Obj. č.: 769-111/000-036</b> 1 vodičová pružinová svorkovnice; 4 mm <sup>2</sup> ; 11pól.; 4,00 mm <sup>2</sup> ; Šedá / zelená – žlutá	<a href="http://www.wago.com/769-111/000-036">www.wago.com/769-111/000-036</a>
	<b>Obj. č.: 769-111/000-037</b> 1 vodičová pružinová svorkovnice; 4 mm <sup>2</sup> ; 11pól.; 4,00 mm <sup>2</sup> ; Zelená – žlutá / šedá	<a href="http://www.wago.com/769-111/000-037">www.wago.com/769-111/000-037</a>
	<b>Obj. č.: 769-111/000-038</b> 1 vodičová pružinová svorkovnice; 4 mm <sup>2</sup> ; 11pól.; 4,00 mm <sup>2</sup> ; Šedá / modrá / zelená – žlutá	<a href="http://www.wago.com/769-111/000-038">www.wago.com/769-111/000-038</a>
	<b>Obj. č.: 769-111/000-039</b> 1 vodičová pružinová svorkovnice; 4 mm <sup>2</sup> ; 11pól.; 4,00 mm <sup>2</sup> ; Zelená – žlutá, modrá, šedá	<a href="http://www.wago.com/769-111/000-039">www.wago.com/769-111/000-039</a>
	<b>Obj. č.: 769-121</b> 2 vodičová pružinová svorkovnice; 4 mm <sup>2</sup> ; 1pól.; 4,00 mm <sup>2</sup> ; Šedá	<a href="http://www.wago.com/769-121">www.wago.com/769-121</a>



**Obj. č.: 769-121/000-016**  
2vodičová pružinová svorkovnice; 4 mm<sup>2</sup>; 1pól.; 4,00 mm<sup>2</sup>; Zeleno-žlutá

[www.wago.com/769-121/000-016](http://www.wago.com/769-121/000-016)



**Obj. č.: 769-122**  
2vodičová pružinová svorkovnice; 4 mm<sup>2</sup>; 2pól.; 4,00 mm<sup>2</sup>; Šedá

[www.wago.com/769-122](http://www.wago.com/769-122)



**Obj. č.: 769-123**  
2vodičová pružinová svorkovnice; 4 mm<sup>2</sup>; 3pól.; 4,00 mm<sup>2</sup>; Šedá

[www.wago.com/769-123](http://www.wago.com/769-123)



**Obj. č.: 769-124**  
2vodičová pružinová svorkovnice; 4 mm<sup>2</sup>; 4pól.; 4,00 mm<sup>2</sup>; Šedá

[www.wago.com/769-124](http://www.wago.com/769-124)



**Obj. č.: 769-125**  
2vodičová pružinová svorkovnice; 4 mm<sup>2</sup>; 5pól.; 4,00 mm<sup>2</sup>; Šedá

[www.wago.com/769-125](http://www.wago.com/769-125)



**Obj. č.: 769-126**  
2vodičová pružinová svorkovnice; 4 mm<sup>2</sup>; 6pól.; 4,00 mm<sup>2</sup>; Šedá

[www.wago.com/769-126](http://www.wago.com/769-126)



**Obj. č.: 769-127**  
2vodičová pružinová svorkovnice; 4 mm<sup>2</sup>; 7pól.; 4,00 mm<sup>2</sup>; Šedá

[www.wago.com/769-127](http://www.wago.com/769-127)



**Obj. č.: 769-128**  
2vodičová pružinová svorkovnice; 4 mm<sup>2</sup>; 8pól.; 4,00 mm<sup>2</sup>; Šedá

[www.wago.com/769-128](http://www.wago.com/769-128)



**Obj. č.: 769-129**  
2vodičová pružinová svorkovnice; 4 mm<sup>2</sup>; 9pól.; 4,00 mm<sup>2</sup>; Šedá

[www.wago.com/769-129](http://www.wago.com/769-129)



**Obj. č.: 769-130**  
2vodičová pružinová svorkovnice; 4 mm<sup>2</sup>; 10pól.; 4,00 mm<sup>2</sup>; Šedá

[www.wago.com/769-130](http://www.wago.com/769-130)

#### Strain relief plate



**Obj. č.: 769-410**  
Podložka pro odlehčení tahu; Šedá

[www.wago.com/769-410](http://www.wago.com/769-410)



**Obj. č.: 769-414**  
Podložka pro odlehčení tahu; Šedá

[www.wago.com/769-414](http://www.wago.com/769-414)

#### Insulation stop



**Obj. č.: 769-470**  
Izolační zarážka; 0,08–0,2 mm<sup>2</sup> „e“ (0,14 mm<sup>2</sup> „f“); 5 ks/pás; Bílá

[www.wago.com/769-470](http://www.wago.com/769-470)



**Obj. č.: 769-471**  
Izolační zarážka; 0,25–0,5 mm<sup>2</sup>; 5 ks/pás; Světle šedá

[www.wago.com/769-471](http://www.wago.com/769-471)



**Obj. č.: 769-472**  
Izolační zarážka; 0,75–1 mm<sup>2</sup>; 5 ks/pás; Tmavě šedá

[www.wago.com/769-472](http://www.wago.com/769-472)

#### Coding



**Obj. č.: 769-435**  
Kódovací kolík; Ke kódování pružinových svorkovnic; Pro základní svorky / konektory s pájecími piny; Oranžová















[www.wago.com/769-435](http://www.wago.com/769-435)

#### Marking accessories



**Obj. č.: 2009-145**  
Mini-WSB Inline; Pro Smart Printer; Na cívce; Flexibilní, 5–5,2 mm; Bez potisku; Možnost naklapnutí; Bílá

[www.wago.com/2009-145](http://www.wago.com/2009-145)

	<b>Obj. č.: 2009-145/000-002</b> Mini-WSB Inline; Pro Smart Printer; Na cívce; Flexibilní, 5–5,2 mm; Bez potisku; Možnost naklapnutí; Žlutá	<a href="http://www.wago.com/2009-145/000-002">www.wago.com/2009-145/000-002</a>
	<b>Obj. č.: 2009-145/000-005</b> Mini-WSB Inline; Pro Smart Printer; Na cívce; Flexibilní, 5–5,2 mm; Bez potisku; Možnost naklapnutí; Červená	<a href="http://www.wago.com/2009-145/000-005">www.wago.com/2009-145/000-005</a>
	<b>Obj. č.: 2009-145/000-006</b> Mini-WSB Inline; Pro Smart Printer; Na cívce; Flexibilní, 5–5,2 mm; Bez potisku; Možnost naklapnutí; Modrá	<a href="http://www.wago.com/2009-145/000-006">www.wago.com/2009-145/000-006</a>
	<b>Obj. č.: 2009-145/000-007</b> Mini-WSB Inline; Pro Smart Printer; Na cívce; Flexibilní, 5–5,2 mm; Bez potisku; Možnost naklapnutí; Šedá	<a href="http://www.wago.com/2009-145/000-007">www.wago.com/2009-145/000-007</a>
	<b>Obj. č.: 2009-145/000-012</b> Mini-WSB Inline; Pro Smart Printer; Na cívce; Flexibilní, 5–5,2 mm; Bez potisku; Možnost naklapnutí; Oranžová	<a href="http://www.wago.com/2009-145/000-012">www.wago.com/2009-145/000-012</a>
	<b>Obj. č.: 2009-145/000-023</b> Mini-WSB Inline; Pro Smart Printer; Na cívce; Flexibilní, 5–5,2 mm; Bez potisku; Možnost naklapnutí; Zelená	<a href="http://www.wago.com/2009-145/000-023">www.wago.com/2009-145/000-023</a>
	<b>Obj. č.: 2009-145/000-024</b> Mini-WSB Inline; Pro Smart Printer; Na cívce; Flexibilní, 5–5,2 mm; Bez potisku; Možnost naklapnutí; Fialová	<a href="http://www.wago.com/2009-145/000-024">www.wago.com/2009-145/000-024</a>
	<b>Obj. č.: 210-831</b> Popisovací páska; Na cívce; Šířka 2,3 mm; Bez potisku; Samolepicí; Bílá	<a href="http://www.wago.com/210-831">www.wago.com/210-831</a>
	<b>Obj. č.: 210-832</b> Popisovací páska; Na cívce; Šířka 3 mm; Bez potisku; Samolepicí; Bílá	<a href="http://www.wago.com/210-832">www.wago.com/210-832</a>
	<b>Obj. č.: 210-833</b> Popisovací páska; Na cívce; Šířka 6 mm; Bez potisku; Samolepicí; Bílá	<a href="http://www.wago.com/210-833">www.wago.com/210-833</a>
	<b>Obj. č.: 210-834</b> Popisovací páska; Na cívce; Šířka 5 mm; Bez potisku; Samolepicí; Bílá	<a href="http://www.wago.com/210-834">www.wago.com/210-834</a>
	<b>Obj. č.: 248-501</b> Systém rychlého popisování Mini-WSB; Bez potisku; Šířka štítků 5 mm; 10 řad po 10 štítcích na každé kartě	<a href="http://www.wago.com/248-501">www.wago.com/248-501</a>
	<b>Obj. č.: 248-501/000-002</b> Popisovací karta Mini-WSB; Jako karta; Neflexibilní; Bez potisku; Možnost naklapnutí; Žlutá	<a href="http://www.wago.com/248-501/000-002">www.wago.com/248-501/000-002</a>
	<b>Obj. č.: 248-501/000-005</b> Popisovací karta Mini-WSB; Jako karta; Neflexibilní; Bez potisku; Možnost naklapnutí; Červená	<a href="http://www.wago.com/248-501/000-005">www.wago.com/248-501/000-005</a>
	<b>Obj. č.: 248-501/000-006</b> Popisovací karta Mini-WSB; Jako karta; Neflexibilní; Bez potisku; Možnost naklapnutí; Modrá	<a href="http://www.wago.com/248-501/000-006">www.wago.com/248-501/000-006</a>
	<b>Obj. č.: 248-501/000-007</b> Popisovací karta Mini-WSB; Jako karta; Neflexibilní; Bez potisku; Možnost naklapnutí; Šedá	<a href="http://www.wago.com/248-501/000-007">www.wago.com/248-501/000-007</a>





**Obj. č.: 248-501/000-012**  
Popisovací karta Mini-WSB; Jako karta; Neflexibilní; Bez potisku; Možnost naklapnutí; Oranžová

[www.wago.com/248-501/000-012](http://www.wago.com/248-501/000-012)



**Obj. č.: 248-501/000-017**  
Popisovací karta Mini-WSB; Jako karta; Neflexibilní; Bez potisku; Možnost naklapnutí; Světle zelená

[www.wago.com/248-501/000-017](http://www.wago.com/248-501/000-017)



**Obj. č.: 248-501/000-023**  
Popisovací karta Mini-WSB; Jako karta; Neflexibilní; Bez potisku; Možnost naklapnutí; Zelená

[www.wago.com/248-501/000-023](http://www.wago.com/248-501/000-023)



**Obj. č.: 248-501/000-024**  
Popisovací karta Mini-WSB; Jako karta; Neflexibilní; Bez potisku; Možnost naklapnutí; Fialová

[www.wago.com/248-501/000-024](http://www.wago.com/248-501/000-024)

#### Protective Warning Marker



**Obj. č.: 280-415**  
Výstražný kryt; S černým symbolem blesku; Pro 5 svorek; Žlutá

[www.wago.com/280-415](http://www.wago.com/280-415)

#### ferrule



**Obj. č.: 216-101**  
Dutinka; Objímka na 0,5 mm<sup>2</sup> / AWG 22; Bez plastového límce; Galvanicky pocínováno

[www.wago.com/216-101](http://www.wago.com/216-101)



**Obj. č.: 216-102**  
Dutinka; Objímka na 0,75 mm<sup>2</sup> / AWG 20; Bez plastového límce; Galvanicky pocínováno

[www.wago.com/216-102](http://www.wago.com/216-102)



**Obj. č.: 216-103**  
Dutinka; Objímka na 1 mm<sup>2</sup> / AWG 18; Bez plastového límce; Galvanicky pocínováno

[www.wago.com/216-103](http://www.wago.com/216-103)



**Obj. č.: 216-104**  
Dutinka; Objímka na 1,5 mm<sup>2</sup> / AWG 16; Bez plastového límce; Galvanicky pocínováno

[www.wago.com/216-104](http://www.wago.com/216-104)



**Obj. č.: 216-201**  
Ferrule; Sleeve for 0.5 mm<sup>2</sup> / 20 AWG; insulated; electro-tin plated; white

[www.wago.com/216-201](http://www.wago.com/216-201)



**Obj. č.: 216-202**  
Ferrule; Sleeve for 0.75 mm<sup>2</sup> / 18 AWG; insulated; electro-tin plated; gray

[www.wago.com/216-202](http://www.wago.com/216-202)



**Obj. č.: 216-203**  
Dutinka; Objímka na 1 mm<sup>2</sup> / AWG 18; S plastovým límcem; Galvanicky pocínováno; Červená

[www.wago.com/216-203](http://www.wago.com/216-203)



**Obj. č.: 216-204**  
Dutinka; Objímka na 1,5 mm<sup>2</sup> / AWG 16; S plastovým límcem; Galvanicky pocínováno; Černá

[www.wago.com/216-204](http://www.wago.com/216-204)



**Obj. č.: 216-206**  
Dutinka; Objímka na 2,5 mm<sup>2</sup> / AWG 14; S plastovým límcem; Galvanicky pocínováno; Modrá

[www.wago.com/216-206](http://www.wago.com/216-206)

#### tools



**Obj. č.: 210-490**  
Ovládací nástroj

[www.wago.com/210-490](http://www.wago.com/210-490)



**Obj. č.: 769-434**  
Ovládací tlačítko; Volný

[www.wago.com/769-434](http://www.wago.com/769-434)

## Ke stažení Documentation

### Additional Information

Technical explanations	03-Apr-2019	pdf 2,1 MB	Stáhnout
------------------------	-------------	---------------	----------

## CAD/CAE-Data

### CAD data

2D/3D Models 769-611/006-000	URL	Stáhnout
------------------------------	-----	----------

### CAE data

EPLAN Data Portal 769-611/006-000	Stáhnout
-----------------------------------	----------

WSCAD Universe 769-611/006-000	Stáhnout
--------------------------------	----------

## Handling Instructions

### Assembly

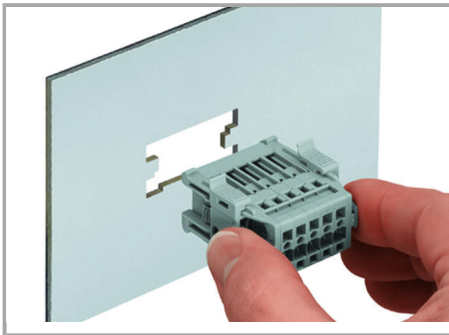

Insert male connector with snap-in flanges (769-605/006-000) into the cutout.

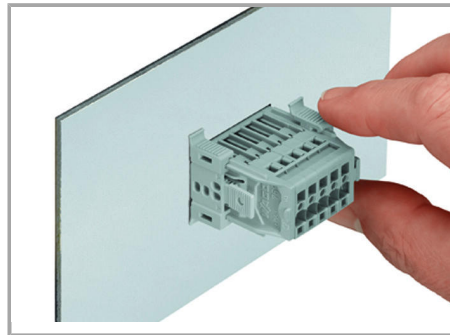

Secure the snap-in flange.

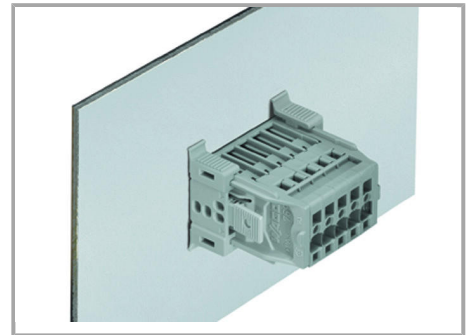

Stilleiste mit Snap-In-Flanschen (769-605 /006-000) im Blechausschnitt

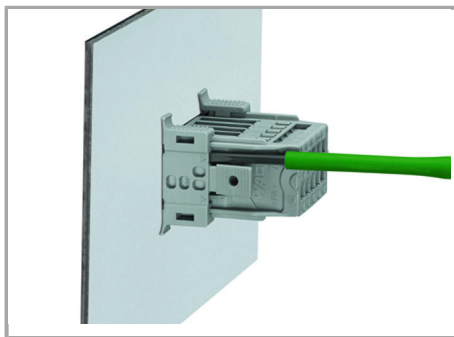

For removal, insert operating tool (2.5 mm blade) into release slot.

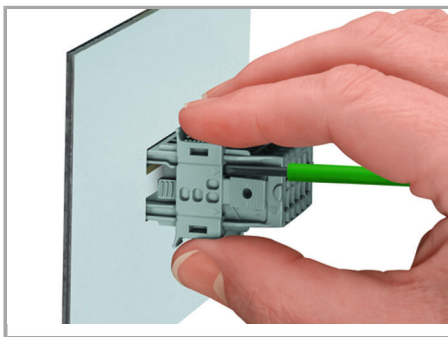

Press center part on both the top and bottom of the connector. Then remove snap-in flange.

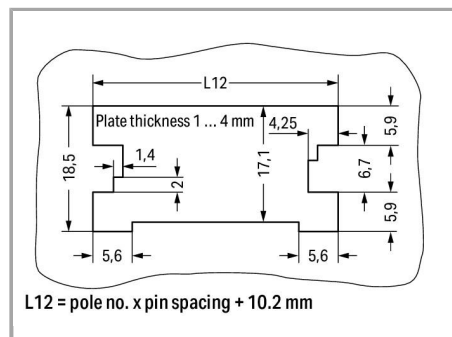

Sheet metal cutout (for female plugs without locking levers)

Male connectors with CAGE CLAMP® connection (769-6xx/006-000) and snap-in flanges

#### Inserting a conductor

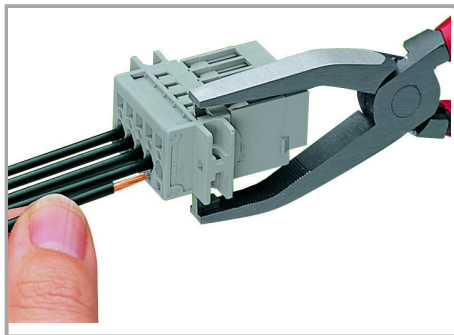

Operating tool

Inserting a conductor via operating tool (example shows a male connector).

#### Marking

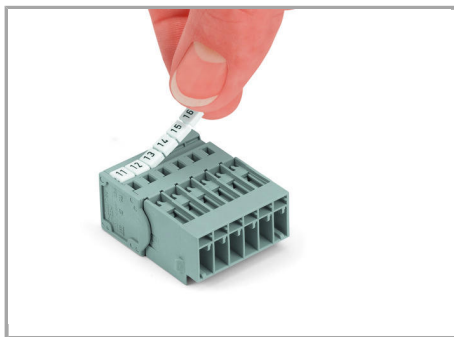

Labeling a male connector with  
CAGE CLAMP® connection via Mini-WSB  
quick markers.

## Produktová rodina

**X-COM**

[Zobrazit všechny produkty z rodiny](#)

Změny vyhrazeny.

---

WAGO Elektro spol. sr. o.  
Rozvodova 1116/36  
143 00 Praha 12 - Modřany  
Tel.: +420 261 090 143  
Email: [info.cz@wago.com](mailto:info.cz@wago.com), [wago-cz@wago.com](mailto:wago-cz@wago.com)

Máte otázky ohledně našich produktů?  
Kdykoli nám zavolejte na číslo +420 261 090 143.