

Datový list | Objednací číslo: 769-609/006-000

1 vodičový konektor s pájecími piny; Zajišťovací příruba; 4 mm²; Rozteč 5 mm; 9pól.; 4,00 mm²; Šedá

www.wago.com/769-609/006-000

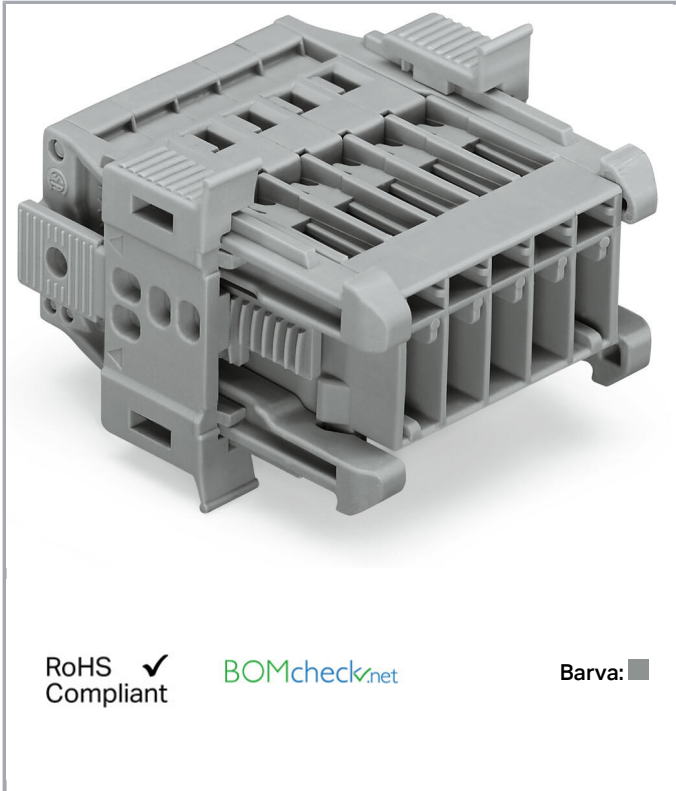

RoHS Compliant

BOMcheck.net

Barva: ■

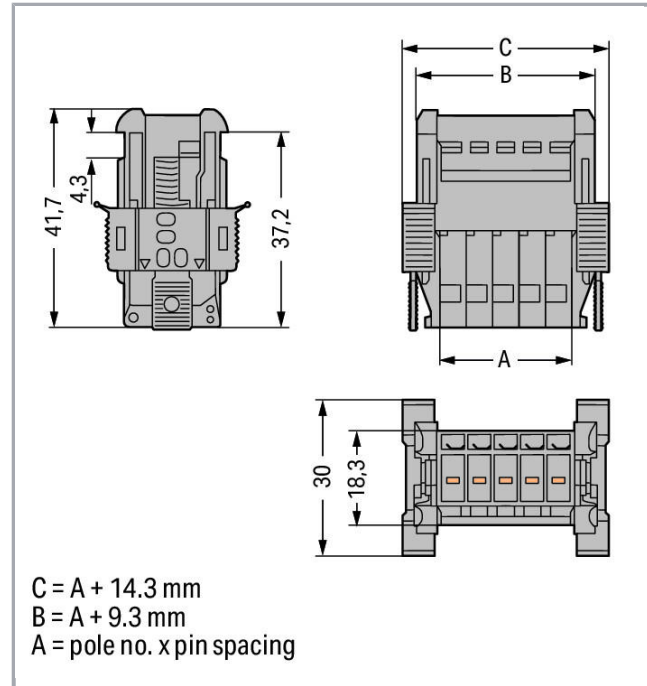

Data

Elektrické parametry

Ratings per IEC/EN 60664-1

| | |
|----------------------------------|---|
| Návrhové napětí (III / 3) | 500 V |
| Návrhové rázové napětí (III / 3) | 6 kV |
| Jmenovitý proud | 32 A |
| Legenda (návrhové hodnoty) | (III / 3) ≙ kategorie přepětí III / stupeň znečištění 3 |

Údaje o připojení

| | |
|---------------------------------|--|
| Připojovací technika | CAGE CLAMP® |
| Způsob ovládání | Ovládací nástroj |
| Materiály připojitelných vodičů | Měď |
| Jmenovitý průřez | 4 mm ² |
| Plný vodič | 0,08 ... 4 mm ² / 28 ... 12 AWG |
| Jemně laněný vodič | 0,08 ... 4 mm ² / 28 ... 12 AWG |



| | |
|--------------------------------|----------------------------------|
| Délka odizolování | 8 ... 9 mm / 0.31 ... 0.35 palec |
| Počet pólů | 9 |
| Celkový počet kontaktních míst | 9 |
| Celkový počet potenciálů | 9 |
| Způsob zapojení | boční připojení |

Geometrické údaje

| | |
|---------|----------------------|
| Rozteč | 5 mm / 0.197 inch |
| Šířka | 59,3 mm / 2.335 inch |
| Výška | 30 mm / 1.181 inch |
| Hloubka | 41,7 mm / 1.642 inch |

Mechanické parametry

| | |
|-----------------|---------|
| Způsob upevnění | Snap-in |
|-----------------|---------|

Plug connection

| | |
|-------------------------|-------------------------------|
| Typ kontaktu (konektor) | Konektor (vidlice) / zástrčka |
| Typ připojení konektoru | pro vodiče |

Údaje o materiálu

| | |
|-------------------|---------------------|
| barva | Šedá |
| Izolační materiál | Polyamid 66 (PA 66) |
| Požární zatížení | 0.667 MJ |
| Hmotnost | 31.208 g |

Obchodní údaje



| | |
|--------------------|-------------------|
| Product Group | 18 (X-COM-System) |
| Druh balení | BOX |
| Country of origin | PL |
| GTIN | 4045454917067 |
| Customs Tariff No. | 85366990990 |

Atesty/certifikáty**Specifické atesty jednotlivých států**

| Logo | Schválení | Doplňkový text schválení | Název certifikátu |
|--|---------------------------------|--------------------------|-------------------|
|  | CCA DEKRA Certification B.V. | EN 61984 | 2190419.02 |







| | | | |
|--|---------------------------------|---------------|----------|
| | CCA DEKRA Certification B.V. | IEC 61984 | NL-47799 |
|  | CSA DEKRA Certification B.V. | C22.2 No. 158 | 1101144 |















Atesty UL

| Logo | Schválení | Doplňkový text schválení | Název certifikátu |
|--|--------------------------------------|--------------------------|-------------------|
|  | UR Underwriters Laboratories Inc. | UL 1977 | E45171-20010720 |
|  | UR Underwriters Laboratories Inc. | UL 1059 | 31.07.2019-E45172 |

Kompatibilní produkty

Marking accessories

| | | |
|--|---|--|
|  | Obj. č.: 2009-145 Mini-WSB Inline; Pro Smart Printer; Na cívce; Flexibilní, 5–5,2 mm; Bez potisku; Možnost naklapnutí; Bílá | www.wago.com/2009-145 |
|  | Obj. č.: 2009-145/000-002 Mini-WSB Inline; Pro Smart Printer; Na cívce; Flexibilní, 5–5,2 mm; Bez potisku; Možnost naklapnutí; Žlutá | www.wago.com/2009-145/000-002 |
|  | Obj. č.: 2009-145/000-005 Mini-WSB Inline; Pro Smart Printer; Na cívce; Flexibilní, 5–5,2 mm; Bez potisku; Možnost naklapnutí; Červená | www.wago.com/2009-145/000-005 |
|  | Obj. č.: 2009-145/000-006 Mini-WSB Inline; Pro Smart Printer; Na cívce; Flexibilní, 5–5,2 mm; Bez potisku; Možnost naklapnutí; Modrá | www.wago.com/2009-145/000-006 |
|  | Obj. č.: 2009-145/000-007 Mini-WSB Inline; Pro Smart Printer; Na cívce; Flexibilní, 5–5,2 mm; Bez potisku; Možnost naklapnutí; Šedá | www.wago.com/2009-145/000-007 |
|  | Obj. č.: 2009-145/000-012 Mini-WSB Inline; Pro Smart Printer; Na cívce; Flexibilní, 5–5,2 mm; Bez potisku; Možnost naklapnutí; Oranžová | www.wago.com/2009-145/000-012 |

| | | |
|--|--|--|
|  | Obj. č.: 2009-145/000-023 Mini-WSB Inline; Pro Smart Printer; Na cívce; Flexibilní, 5–5,2 mm; Bez potisku; Možnost naklapnutí; Zelená | www.wago.com/2009-145/000-023 |
|  | Obj. č.: 2009-145/000-024 Mini-WSB Inline; Pro Smart Printer; Na cívce; Flexibilní, 5–5,2 mm; Bez potisku; Možnost naklapnutí; Fialová | www.wago.com/2009-145/000-024 |
|  | Obj. č.: 210-831 Popisovací páska; Na cívce; Šířka 2,3 mm; Bez potisku; Samolepicí; Bílá | www.wago.com/210-831 |
|  | Obj. č.: 210-832 Popisovací páska; Na cívce; Šířka 3 mm; Bez potisku; Samolepicí; Bílá | www.wago.com/210-832 |
|  | Obj. č.: 210-833 Popisovací páska; Na cívce; Šířka 6 mm; Bez potisku; Samolepicí; Bílá | www.wago.com/210-833 |
|  | Obj. č.: 210-834 Popisovací páska; Na cívce; Šířka 5 mm; Bez potisku; Samolepicí; Bílá | www.wago.com/210-834 |
|  | Obj. č.: 248-501 Systém rychlého popisování Mini-WSB; Bez potisku; Šířka štítků 5 mm; 10 řad po 10 štítcích na každé kartě | www.wago.com/248-501 |
|  | Obj. č.: 248-501/000-002 Popisovací karta Mini-WSB; Jako karta; Neflexibilní; Bez potisku; Možnost naklapnutí; Žlutá | www.wago.com/248-501/000-002 |
|  | Obj. č.: 248-501/000-005 Popisovací karta Mini-WSB; Jako karta; Neflexibilní; Bez potisku; Možnost naklapnutí; Červená | www.wago.com/248-501/000-005 |
|  | Obj. č.: 248-501/000-006 Popisovací karta Mini-WSB; Jako karta; Neflexibilní; Bez potisku; Možnost naklapnutí; Modrá | www.wago.com/248-501/000-006 |
|  | Obj. č.: 248-501/000-007 Popisovací karta Mini-WSB; Jako karta; Neflexibilní; Bez potisku; Možnost naklapnutí; Šedá | www.wago.com/248-501/000-007 |
|  | Obj. č.: 248-501/000-012 Popisovací karta Mini-WSB; Jako karta; Neflexibilní; Bez potisku; Možnost naklapnutí; Oranžová | www.wago.com/248-501/000-012 |
|  | Obj. č.: 248-501/000-017 Popisovací karta Mini-WSB; Jako karta; Neflexibilní; Bez potisku; Možnost naklapnutí; Světle zelená | www.wago.com/248-501/000-017 |
|  | Obj. č.: 248-501/000-023 Popisovací karta Mini-WSB; Jako karta; Neflexibilní; Bez potisku; Možnost naklapnutí; Zelená | www.wago.com/248-501/000-023 |
|  | Obj. č.: 248-501/000-024 Popisovací karta Mini-WSB; Jako karta; Neflexibilní; Bez potisku; Možnost naklapnutí; Fialová | www.wago.com/248-501/000-024 |

Strain relief plate

| | | |
|--|--|--|
|  | Obj. č.: 769-410 Podložka pro odlehčení tahu; Šedá | www.wago.com/769-410 |
|--|--|--|



Obj. č.: 769-413
Podložka pro odlehčení tahu; Šedá

www.wago.com/769-413

Coding



Obj. č.: 769-435
Kódovací kolík; Ke kódování pružinových svorkovnic; Pro základní svorky / konektory s pájecími piny; Oranžová

www.wago.com/769-435

Female plug



Obj. č.: 769-101
1 vodičová pružinová svorkovnice; 4 mm²; 1pól.; 4,00 mm²; Šedá

www.wago.com/769-101



Obj. č.: 769-101/000-016
1 vodičová pružinová svorkovnice; 4 mm²; 1pól.; 4,00 mm²; Zeleno-žlutá

www.wago.com/769-101/000-016



Obj. č.: 769-102
1 vodičová pružinová svorkovnice; 4 mm²; 2pól.; 4,00 mm²; Šedá

www.wago.com/769-102



Obj. č.: 769-102/000-036
1 vodičová pružinová svorkovnice; 4 mm²; 2pól.; 4,00 mm²; Šedá / zelená – žlutá

www.wago.com/769-102/000-036



Obj. č.: 769-102/000-037
1 vodičová pružinová svorkovnice; 4 mm²; 2pól.; 4,00 mm²; Zelená – žlutá / šedá

www.wago.com/769-102/000-037



Obj. č.: 769-103
1 vodičová pružinová svorkovnice; 4 mm²; 3pól.; 4,00 mm²; Šedá

www.wago.com/769-103



Obj. č.: 769-103/000-036
1 vodičová pružinová svorkovnice; 4 mm²; 3pól.; 4,00 mm²; Šedá / zelená – žlutá

www.wago.com/769-103/000-036



Obj. č.: 769-103/000-037
1 vodičová pružinová svorkovnice; 4 mm²; 3pól.; 4,00 mm²; Zelená – žlutá / šedá

www.wago.com/769-103/000-037



Obj. č.: 769-103/000-038
1 vodičová pružinová svorkovnice; 4 mm²; 3pól.; 4,00 mm²; Šedá / modrá / zelená – žlutá

www.wago.com/769-103/000-038



Obj. č.: 769-103/000-039
1 vodičová pružinová svorkovnice; 4 mm²; 3pól.; 4,00 mm²; Zelená – žlutá, modrá, šedá

www.wago.com/769-103/000-039



Obj. č.: 769-104
1 vodičová pružinová svorkovnice; 4 mm²; 4pól.; 4,00 mm²; Šedá

www.wago.com/769-104

















Obj. č.: 769-104/000-036
1 vodičová pružinová svorkovnice; 4 mm²; 4pól.; 4,00 mm²; Šedá / zelená – žlutá

www.wago.com/769-104/000-036



Obj. č.: 769-104/000-037
1 vodičová pružinová svorkovnice; 4 mm²; 4pól.; 4,00 mm²; Zelená – žlutá / šedá

www.wago.com/769-104/000-037

| | | |
|--|--|--|
|  | Obj. č.: 769-104/000-038 1 vodičová pružinová svorkovnice; 4 mm ² ; 4pól.; 4,00 mm ² ; Šedá / modrá / zelená – žlutá | www.wago.com/769-104/000-038 |
|  | Obj. č.: 769-104/000-039 1 vodičová pružinová svorkovnice; 4 mm ² ; 4pól.; 4,00 mm ² ; Zelená – žlutá, modrá, šedá | www.wago.com/769-104/000-039 |
|  | Obj. č.: 769-105 1 vodičová pružinová svorkovnice; 4 mm ² ; 5pól.; 4,00 mm ² ; Šedá | www.wago.com/769-105 |
|  | Obj. č.: 769-105/000-036 1 vodičová pružinová svorkovnice; 4 mm ² ; 5pól.; 4,00 mm ² ; Šedá / zelená – žlutá | www.wago.com/769-105/000-036 |
|  | Obj. č.: 769-105/000-037 1 vodičová pružinová svorkovnice; 4 mm ² ; 5pól.; 4,00 mm ² ; Zelená – žlutá / šedá | www.wago.com/769-105/000-037 |
|  | Obj. č.: 769-105/000-038 1 vodičová pružinová svorkovnice; 4 mm ² ; 5pól.; 4,00 mm ² ; Šedá / modrá / zelená – žlutá | www.wago.com/769-105/000-038 |
|  | Obj. č.: 769-105/000-039 1 vodičová pružinová svorkovnice; 4 mm ² ; 5pól.; 4,00 mm ² ; Zelená – žlutá, modrá, šedá | www.wago.com/769-105/000-039 |
|  | Obj. č.: 769-106 1 vodičová pružinová svorkovnice; 4 mm ² ; 6pól.; 4,00 mm ² ; Šedá | www.wago.com/769-106 |
|  | Obj. č.: 769-106/000-006 1 vodičová pružinová svorkovnice; 4 mm ² ; 6pól.; 4,00 mm ² ; Modrá | www.wago.com/769-106/000-006 |
|  | Obj. č.: 769-106/000-036 1 vodičová pružinová svorkovnice; 4 mm ² ; 6pól.; 4,00 mm ² ; Šedá / zelená – žlutá | www.wago.com/769-106/000-036 |
|  | Obj. č.: 769-106/000-037 1 vodičová pružinová svorkovnice; 4 mm ² ; 6pól.; 4,00 mm ² ; Zelená – žlutá / šedá | www.wago.com/769-106/000-037 |
|  | Obj. č.: 769-106/000-038 1 vodičová pružinová svorkovnice; 4 mm ² ; 6pól.; 4,00 mm ² ; Šedá / modrá / zelená – žlutá | www.wago.com/769-106/000-038 |
|  | Obj. č.: 769-106/000-039 1 vodičová pružinová svorkovnice; 4 mm ² ; 6pól.; 4,00 mm ² ; Zelená – žlutá, modrá, šedá | www.wago.com/769-106/000-039 |
|  | Obj. č.: 769-107 1 vodičová pružinová svorkovnice; 4 mm ² ; 7pól.; 4,00 mm ² ; Šedá | www.wago.com/769-107 |
|  | Obj. č.: 769-107/000-036 1 vodičová pružinová svorkovnice; 4 mm ² ; 7pól.; 4,00 mm ² ; Šedá / zelená – žlutá | www.wago.com/769-107/000-036 |



Obj. č.: 769-107/000-037

1 vodičová pružinová svorkovnice; 4 mm²; 7pól.; 4,00 mm²; Zelená – žlutá / šedá

www.wago.com/769-107/000-037



Obj. č.: 769-107/000-038

1 vodičová pružinová svorkovnice; 4 mm²; 7pól.; 4,00 mm²; Šedá / modrá / zelená – žlutá

www.wago.com/769-107/000-038



Obj. č.: 769-107/000-039

1 vodičová pružinová svorkovnice; 4 mm²; 7pól.; 4,00 mm²; Zelená – žlutá, modrá, šedá

www.wago.com/769-107/000-039



Obj. č.: 769-108

1 vodičová pružinová svorkovnice; 4 mm²; 8pól.; 4,00 mm²; Šedá

www.wago.com/769-108



Obj. č.: 769-108/000-036

1 vodičová pružinová svorkovnice; 4 mm²; 8pól.; 4,00 mm²; Šedá / zelená – žlutá

www.wago.com/769-108/000-036



Obj. č.: 769-108/000-037

1 vodičová pružinová svorkovnice; 4 mm²; 8pól.; 4,00 mm²; Zelená – žlutá / šedá

www.wago.com/769-108/000-037



Obj. č.: 769-108/000-038

1 vodičová pružinová svorkovnice; 4 mm²; 8pól.; 4,00 mm²; Šedá / modrá / zelená – žlutá

www.wago.com/769-108/000-038



Obj. č.: 769-108/000-039

1 vodičová pružinová svorkovnice; 4 mm²; 8pól.; 4,00 mm²; Zelená – žlutá, modrá, šedá

www.wago.com/769-108/000-039



Obj. č.: 769-109/000-036

1 vodičová pružinová svorkovnice; 4 mm²; 9pól.; 4,00 mm²; Šedá / zelená – žlutá

www.wago.com/769-109/000-036



Obj. č.: 769-109/000-037

1 vodičová pružinová svorkovnice; 4 mm²; 9pól.; 4,00 mm²; Zelená – žlutá / šedá

www.wago.com/769-109/000-037



Obj. č.: 769-109/000-038

1 vodičová pružinová svorkovnice; 4 mm²; 9pól.; 4,00 mm²; Šedá / modrá / zelená – žlutá

www.wago.com/769-109/000-038



Obj. č.: 769-109/000-039

1 vodičová pružinová svorkovnice; 4 mm²; 9pól.; 4,00 mm²; Zelená – žlutá, modrá, šedá

www.wago.com/769-109/000-039



Obj. č.: 769-121

2 vodičová pružinová svorkovnice; 4 mm²; 1pól.; 4,00 mm²; Šedá

www.wago.com/769-121



Obj. č.: 769-121/000-016

2 vodičová pružinová svorkovnice; 4 mm²; 1pól.; 4,00 mm²; Zeleno-žlutá



















www.wago.com/769-121/000-016



Obj. č.: 769-122

2 vodičová pružinová svorkovnice; 4 mm²; 2pól.; 4,00 mm²; Šedá

www.wago.com/769-122

| | | |
|--|---|--|
|  | Obj. č.: 769-123 2vodičová pružinová svorkovnice; 4 mm ² ; 3pól.; 4,00 mm ² ; Šedá | www.wago.com/769-123 |
|  | Obj. č.: 769-124 2vodičová pružinová svorkovnice; 4 mm ² ; 4pól.; 4,00 mm ² ; Šedá | www.wago.com/769-124 |
|  | Obj. č.: 769-125 2vodičová pružinová svorkovnice; 4 mm ² ; 5pól.; 4,00 mm ² ; Šedá | www.wago.com/769-125 |
|  | Obj. č.: 769-126 2vodičová pružinová svorkovnice; 4 mm ² ; 6pól.; 4,00 mm ² ; Šedá | www.wago.com/769-126 |
|  | Obj. č.: 769-127 2vodičová pružinová svorkovnice; 4 mm ² ; 7pól.; 4,00 mm ² ; Šedá | www.wago.com/769-127 |
|  | Obj. č.: 769-128 2vodičová pružinová svorkovnice; 4 mm ² ; 8pól.; 4,00 mm ² ; Šedá | www.wago.com/769-128 |
| tools | | |
|  | Obj. č.: 210-490 Ovládací nástroj | www.wago.com/210-490 |
|  | Obj. č.: 769-434 Ovládací tlačítko; Volný | www.wago.com/769-434 |
| Protective Warning Marker | | |
|  | Obj. č.: 280-415 Výstražný kryt; S černým symbolem blesku; Pro 5 svorek; Žlutá | www.wago.com/280-415 |
| Insulation stop | | |
|  | Obj. č.: 769-470 Izolační zarážka; 0,08–0,2 mm ² „e“ (0,14 mm ² „f“); 5 ks/pás; Bílá | www.wago.com/769-470 |
|  | Obj. č.: 769-471 Izolační zarážka; 0,25–0,5 mm ² ; 5 ks/pás; Světle šedá | www.wago.com/769-471 |
|  | Obj. č.: 769-472 Izolační zarážka; 0,75–1 mm ² ; 5 ks/pás; Tmavě šedá | www.wago.com/769-472 |
| ferrule | | |
|  | Obj. č.: 216-101 Dutinka; Objímka na 0,5 mm ² / AWG 22; Bez plastového límce; Galvanicky pocínováno | www.wago.com/216-101 |
|  | Obj. č.: 216-102 Dutinka; Objímka na 0,75 mm ² / AWG 20; Bez plastového límce; Galvanicky pocínováno | www.wago.com/216-102 |
|  | Obj. č.: 216-103 Dutinka; Objímka na 1 mm ² / AWG 18; Bez plastového límce; Galvanicky pocínováno | www.wago.com/216-103 |
|  | Obj. č.: 216-104 Dutinka; Objímka na 1,5 mm ² / AWG 16; Bez plastového límce; Galvanicky pocínováno | www.wago.com/216-104 |
|  | Obj. č.: 216-201 Ferrule; Sleeve for 0.5 mm ² / 20 AWG; insulated; electro-tin plated; white | www.wago.com/216-201 |
|  | Obj. č.: 216-202 Ferrule; Sleeve for 0.75 mm ² / 18 AWG; insulated; electro-tin plated; gray | www.wago.com/216-202 |



Obj. č.: 216-203

Dutinka; Objímka na 1 mm² / AWG 18; S plastovým límcem; Galvanicky pocínováno; Červená

www.wago.com/216-203



Obj. č.: 216-204

Dutinka; Objímka na 1,5 mm² / AWG 16; S plastovým límcem; Galvanicky pocínováno; Černá

www.wago.com/216-204



Obj. č.: 216-206

Dutinka; Objímka na 2,5 mm² / AWG 14; S plastovým límcem; Galvanicky pocínováno; Modrá

www.wago.com/216-206

Ke stažení

Documentation

Additional Information

| | | | |
|------------------------|-------------|---------------|----------|
| Technical explanations | 03-Apr-2019 | pdf 2,1 MB | Stáhnout |
|------------------------|-------------|---------------|----------|

CAD/CAE-Data

CAD data

| | | |
|------------------------------|-----|----------|
| 2D/3D Models 769-609/006-000 | URL | Stáhnout |
|------------------------------|-----|----------|

CAE data

| | |
|-----------------------------------|----------|
| EPLAN Data Portal 769-609/006-000 | Stáhnout |
|-----------------------------------|----------|

| | |
|--------------------------------|----------|
| WSCAD Universe 769-609/006-000 | Stáhnout |
|--------------------------------|----------|

Handling Instructions

Assembly

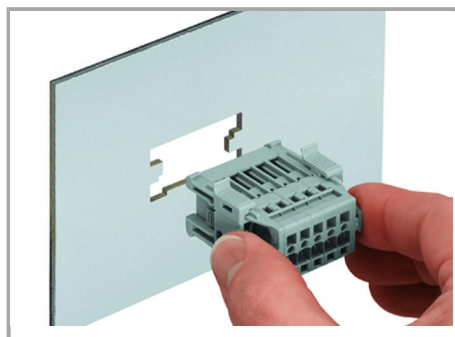

Insert male connector with snap-in flanges (769-605/006-000) into the cutout.

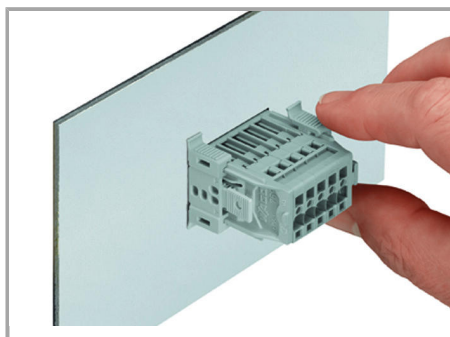

Secure the snap-in flange.

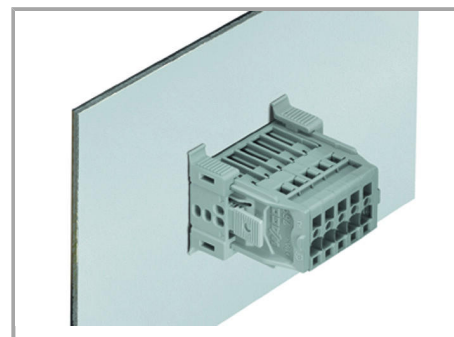

Stitleiste mit Snap-In-Flanschen (769-605 /006-000) im Blechausschnitt

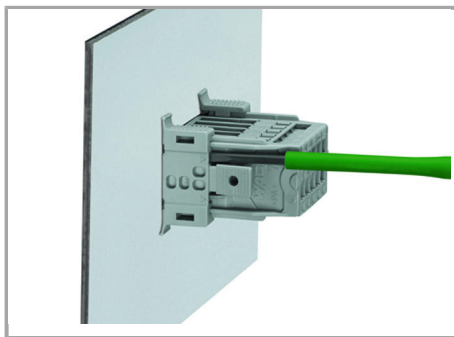

For removal, insert operating tool (2.5 mm blade) into release slot.

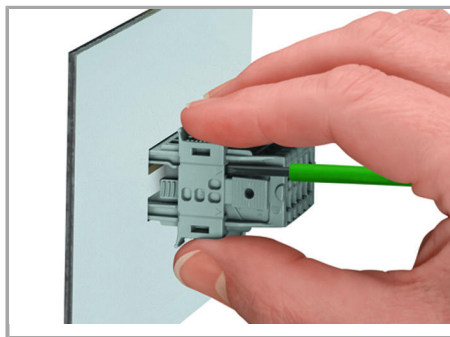

Press center part on both the top and bottom of the connector. Then remove snap-in flange.

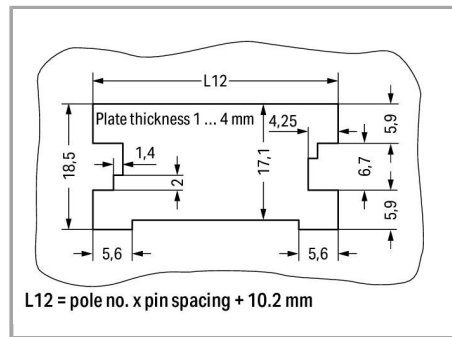

Sheet metal cutout (for female plugs without locking levers)

Male connectors with CAGE CLAMP® connection (769-6xx/006-000) and snap-in flanges

Inserting a conductor

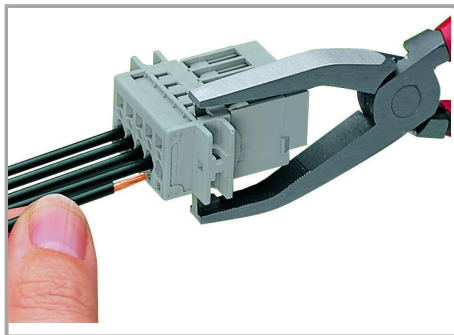

Operating tool

Inserting a conductor via operating tool (example shows a male connector).

Marking

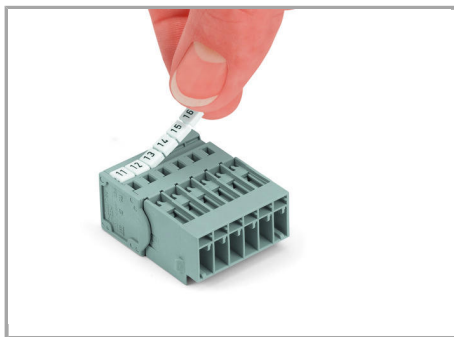

Labeling a male connector with
CAGE CLAMP® connection via Mini-WSB
quick markers.

Produktová rodina

X-COM

[Zobrazit všechny produkty z rodiny](#)

Změny vyhrazeny.

WAGO Elektro spol. sr. o.
Rozvodova 1116/36
143 00 Praha 12 - Modřany
Tel.: +420 261 090 143
Email: info.cz@wago.com, wago-cz@wago.com

Máte otázky ohledně našich produktů?
Kdykoli nám zavolejte na číslo +420 261 090 143.