

## Datový list | Objednáací číslo: 261-260/332-000

4vodičová svorkovnice; 10pól.; S tlačítky na jedné straně; Se západkami; Pro plech o tloušťce 0,6–1,2 mm; Upevňovací otvor Ø 3,5 mm; 2,5 mm<sup>2</sup>; CAGE CLAMP®; 2,50 mm<sup>2</sup>; Šedá

[www.wago.com/261-260/332-000](http://www.wago.com/261-260/332-000)

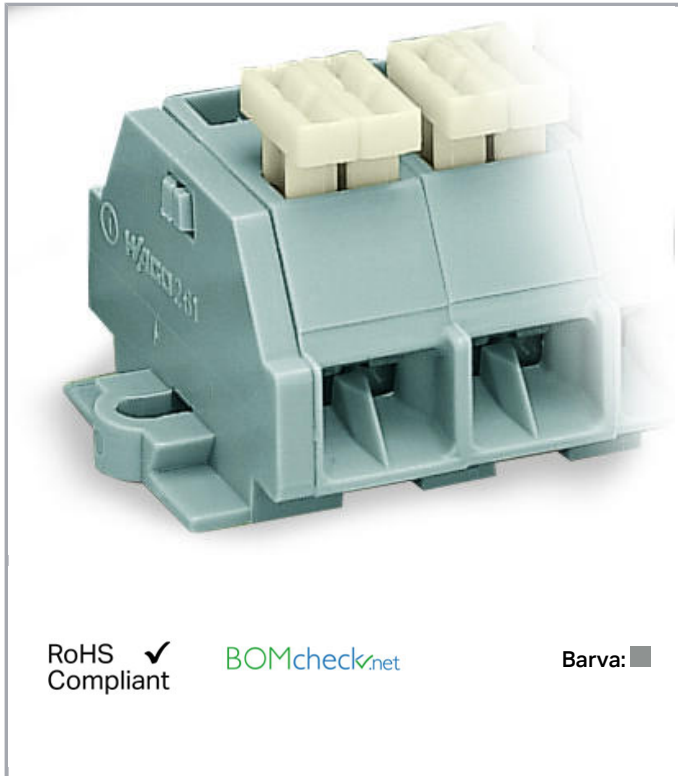

RoHS  Compliant

BOMcheck.net

Barva: ■

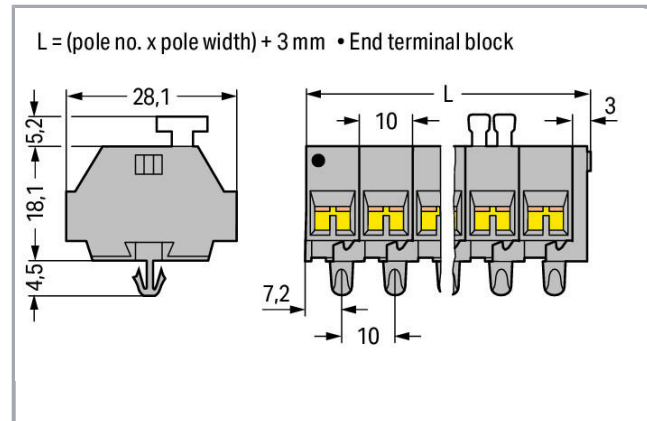

### Data

#### Elektrické parametry

#### Ratings per IEC/EN 60664-1

Návrhové napětí (III / 3)	500 V
Návrhové rázové napětí (III / 3)	6 kV
Jmenovitý proud	24 A
Legenda (návrhové hodnoty)	(III / 3) ≙ kategorie přepětí III / stupeň znečištění 3

#### Údaje o připojení

Připojovací technika	CAGE CLAMP®
Způsob ovládání	Ovládací nástroj Ovládací páčka
Materiály připojitelných vodičů	Měď
Plný vodič	0,08 ... 2,5 mm <sup>2</sup> / 28 ... 14 AWG
Jemně laněný vodič	0,08 ... 2,5 mm <sup>2</sup> / 28 ... 14 AWG
Délka odizolování	8 ... 9 mm / 0.31 ... 0.35 palec



Počet pólů	10
Celkový počet kontaktních míst	40
Celkový počet potenciálů	10
Počet úrovní	1
Způsob zapojení	boční připojení

**Geometrické údaje**

Šířka	104,4 mm / 4.11 inch
Výška od povrchu	23,2 mm / 0.913 inch
Hloubka	28 mm / 1.102 inch
Šířka modulu	10 mm / 0.394 inch

**Mechanické parametry**

Provedení	Horizontální provedení
Způsob upevnění	Západka
Úroveň popisování	Boční popis

**Údaje o materiálu**



barva	Šedá
Hmotnost	42.87 g

**Obchodní údaje**

Druh balení	BOX
Country of origin	DE
GTIN	4044918628273
Customs Tariff No.	85369010000

**Atesty/certifikáty**

## Specifické atesty jednotlivých států

Logo	Schválení	Doplňkový text schválení	Název certifikátu
	CCA DEKRA Certification B.V.	EN 60998	NTR-NL 6509
	CCA DEKRA Certification B.V.	EN 60998	2110272.02

## Atesty pro použití v lodním průmyslu

Název

Logo	Schválení	Doplňkový text schválení	certifikátu
	<b>ABS</b> American Bureau of Shipping	-	19- HG1869868- PDA

## Kompatibilní produkty

### Carrier rail

	<b>Obj. č.: 210-154</b> Hliníková nosná lišta; Délka 1000 mm; Šířka 18 mm; Výška 7 mm; Stříbrná	<a href="http://www.wago.com/210-154">www.wago.com/210-154</a>
--	--	--

### Jumper

	<b>Obj. č.: 261-402</b> Vkládací můstek; Izolováno; 2x; Zmenšuje připojitelný průřez na 1,5 mm; Šedá	<a href="http://www.wago.com/261-402">www.wago.com/261-402</a>
--	---	--

### tools

	<b>Obj. č.: 209-132</b> Ovládací nástroj; K připojení vkládacího můstku; 2x; Z izolačního materiálu	<a href="http://www.wago.com/209-132">www.wago.com/209-132</a>
--	--	--

	<b>Obj. č.: 210-657</b> Ovládací nástroj; Břit: 3,5 × 0,5 mm; S částečně izolovanou rukojetí; Krátké	<a href="http://www.wago.com/210-657">www.wago.com/210-657</a>
--	---	--

	<b>Obj. č.: 210-658</b> Ovládací nástroj; Břit: 3,5 × 0,5 mm; S částečně izolovanou rukojetí; Úhlové provedení; Krátké	<a href="http://www.wago.com/210-658">www.wago.com/210-658</a>
--	---	--

	<b>Obj. č.: 210-720</b> Ovládací nástroj; Břit: 3,5 × 0,5 mm; S částečně izolovanou rukojetí	<a href="http://www.wago.com/210-720">www.wago.com/210-720</a>
--	---	--

### assembling

	<b>Obj. č.: 209-120</b> Montážní patka; Možnost naklápnutí na svorky se západkou; K našroubování na reléové moduly; Šířka 6,4 mm; Šedá	<a href="http://www.wago.com/209-120">www.wago.com/209-120</a>
--	---	--

	<b>Obj. č.: 209-137</b> Montážní adaptér; Lze použít jako koncovou svěrku; Šířka 6,5 mm; Šedá	<a href="http://www.wago.com/209-137">www.wago.com/209-137</a>
--	--	--

### ferrule

	<b>Obj. č.: 216-101</b> Dutinka; Objímka na 0,5 mm <sup>2</sup> / AWG 22; Bez plastového límce; Galvanicky pocínováno	<a href="http://www.wago.com/216-101">www.wago.com/216-101</a>
--	--	--

	<b>Obj. č.: 216-102</b> Dutinka; Objímka na 0,75 mm <sup>2</sup> / AWG 20; Bez plastového límce; Galvanicky pocínováno	<a href="http://www.wago.com/216-102">www.wago.com/216-102</a>
--	---	--

	<b>Obj. č.: 216-103</b> Dutinka; Objímka na 1 mm <sup>2</sup> / AWG 18; Bez plastového límce; Galvanicky pocínováno	<a href="http://www.wago.com/216-103">www.wago.com/216-103</a>
--	--	--

	<b>Obj. č.: 216-104</b> Dutinka; Objímka na 1,5 mm <sup>2</sup> / AWG 16; Bez plastového límce; Galvanicky pocínováno	<a href="http://www.wago.com/216-104">www.wago.com/216-104</a>
--	--	--

	<b>Obj. č.: 216-106</b> Dutinka; Objímka na 2,5 mm <sup>2</sup> / AWG 14; Bez plastového límce; Galvanicky pocínováno	<a href="http://www.wago.com/216-106">www.wago.com/216-106</a>
	<b>Obj. č.: 216-121</b> Dutinka; Objímka na 0,5 mm <sup>2</sup> / AWG 22; Bez plastového límce; Galvanicky pocínováno	<a href="http://www.wago.com/216-121">www.wago.com/216-121</a>
	<b>Obj. č.: 216-122</b> Dutinka; Objímka na 0,75 mm <sup>2</sup> / AWG 20; Bez plastového límce; Galvanicky pocínováno	<a href="http://www.wago.com/216-122">www.wago.com/216-122</a>
	<b>Obj. č.: 216-123</b> Dutinka; Objímka na 1 mm <sup>2</sup> / AWG 18; Bez plastového límce; Galvanicky pocínováno	<a href="http://www.wago.com/216-123">www.wago.com/216-123</a>
	<b>Obj. č.: 216-124</b> Dutinka; Objímka na 1,5 mm <sup>2</sup> / AWG 16; Bez plastového límce; Galvanicky pocínováno	<a href="http://www.wago.com/216-124">www.wago.com/216-124</a>
	<b>Obj. č.: 216-131</b> Dutinka; Objímka na 0,25 mm <sup>2</sup> / AWG 24; Bez plastového límce; Galvanicky pocínováno	<a href="http://www.wago.com/216-131">www.wago.com/216-131</a>
	<b>Obj. č.: 216-132</b> Dutinka; Objímka na 0,34 mm <sup>2</sup> / AWG 24; Bez plastového límce; Galvanicky pocínováno	<a href="http://www.wago.com/216-132">www.wago.com/216-132</a>
	<b>Obj. č.: 216-151</b> Dutinka; Objímka na 0,25 mm <sup>2</sup> / AWG 24; Bez plastového límce; Galvanicky pocínováno	<a href="http://www.wago.com/216-151">www.wago.com/216-151</a>
	<b>Obj. č.: 216-152</b> Dutinka; Objímka na 0,34 mm <sup>2</sup> / AWG 24; Bez plastového límce; Galvanicky pocínováno	<a href="http://www.wago.com/216-152">www.wago.com/216-152</a>
	<b>Obj. č.: 216-201</b> Ferrule; Sleeve for 0.5 mm <sup>2</sup> / 20 AWG; insulated; electro-tin plated; white	<a href="http://www.wago.com/216-201">www.wago.com/216-201</a>
	<b>Obj. č.: 216-202</b> Ferrule; Sleeve for 0.75 mm <sup>2</sup> / 18 AWG; insulated; electro-tin plated; gray	<a href="http://www.wago.com/216-202">www.wago.com/216-202</a>
	<b>Obj. č.: 216-203</b> Dutinka; Objímka na 1 mm <sup>2</sup> / AWG 18; S plastovým límcem; Galvanicky pocínováno; Červená	<a href="http://www.wago.com/216-203">www.wago.com/216-203</a>
	<b>Obj. č.: 216-204</b> Dutinka; Objímka na 1,5 mm <sup>2</sup> / AWG 16; S plastovým límcem; Galvanicky pocínováno; Černá	<a href="http://www.wago.com/216-204">www.wago.com/216-204</a>
	<b>Obj. č.: 216-205</b> Dutinka; Objímka na 2,08 mm <sup>2</sup> / AWG 14; S plastovým límcem; Galvanicky pocínováno; Žlutá	<a href="http://www.wago.com/216-205">www.wago.com/216-205</a>
	<b>Obj. č.: 216-206</b> Dutinka; Objímka na 2,5 mm <sup>2</sup> / AWG 14; S plastovým límcem; Galvanicky pocínováno; Modrá	<a href="http://www.wago.com/216-206">www.wago.com/216-206</a>
	<b>Obj. č.: 216-221</b> Ferrule; Sleeve for 0.5 mm <sup>2</sup> / 20 AWG; insulated; electro-tin plated; white	<a href="http://www.wago.com/216-221">www.wago.com/216-221</a>
	<b>Obj. č.: 216-222</b> Ferrule; Sleeve for 0.75 mm <sup>2</sup> / 18 AWG; insulated; electro-tin plated; gray	<a href="http://www.wago.com/216-222">www.wago.com/216-222</a>
	<b>Obj. č.: 216-223</b> Dutinka; Objímka na 1 mm <sup>2</sup> / AWG 18; S plastovým límcem; Galvanicky pocínováno; Červená	<a href="http://www.wago.com/216-223">www.wago.com/216-223</a>
	<b>Obj. č.: 216-224</b> Dutinka; Objímka na 1,5 mm <sup>2</sup> / AWG 16; S plastovým límcem; Galvanicky pocínováno; Černá	<a href="http://www.wago.com/216-224">www.wago.com/216-224</a>
	<b>Obj. č.: 216-301</b> Dutinka; Objímka na 0,25 mm <sup>2</sup> / AWG 24; S plastovým límcem; Galvanicky pocínováno; Žlutá	<a href="http://www.wago.com/216-301">www.wago.com/216-301</a>



Obj. č.: 216-302  
Ferrule; Sleeve for 0.34 mm<sup>2</sup> / 22 AWG; insulated; electro-tin plated; green

[www.wago.com/216-302](http://www.wago.com/216-302)

Obj. č.: 216-321  
Dutinka; Objímka na 0,25 mm<sup>2</sup> / AWG 24; S plastovým límcem; Galvanicky pocínováno; Žlutá

[www.wago.com/216-321](http://www.wago.com/216-321)



Obj. č.: 216-322  
Ferrule; Sleeve for 0.34 mm<sup>2</sup> / 22 AWG; insulated; electro-tin plated; green

[www.wago.com/216-322](http://www.wago.com/216-322)

#### General accessories



Obj. č.: 209-122  
Plastová koncová svěrka; Možnost popisování systémem WSB; Na hliníkovou lištu 210-154; Šedá

[www.wago.com/209-122](http://www.wago.com/209-122)

#### Ke stažení

##### Documentation

##### Additional Information

Technical explanations	03-Apr-2019	pdf 2,1 MB	Stáhnout
------------------------	-------------	---------------	----------

##### CAD/CAE-Data

###### CAD data

2D/3D Models 261-260/332-000	URL	Stáhnout
------------------------------	-----	----------

###### CAE data

EPLAN Data Portal 261-260/332-000	Stáhnout
-----------------------------------	----------

WSCAD Universe 261-260/332-000	Stáhnout
--------------------------------	----------

#### Handling Instructions

Změny vyhrazeny.

WAGO Elektro spol. sr. o.  
Rozvodova 1116/36  
143 00 Praha 12 - Modřany  
Tel.: +420 261 090 143  
Email: [info.cz@wago.com](mailto:info.cz@wago.com), [wago-cz@wago.com](mailto:wago-cz@wago.com)

Máte otázky ohledně našich produktů?  
Kdykoli nám zavolejte na číslo +420 261 090 143.