

Datový list | Objednací číslo: 261-211/342-000

4-conductor terminal strip; 11-pole; on both sides with push-buttons; with fixing flanges; for screw or similar mounting types; Fixing hole 3.2 mm Ø; 2.5 mm²; CAGE CLAMP®; 2,50 mm²; gray

www.wago.com/261-211/342-000

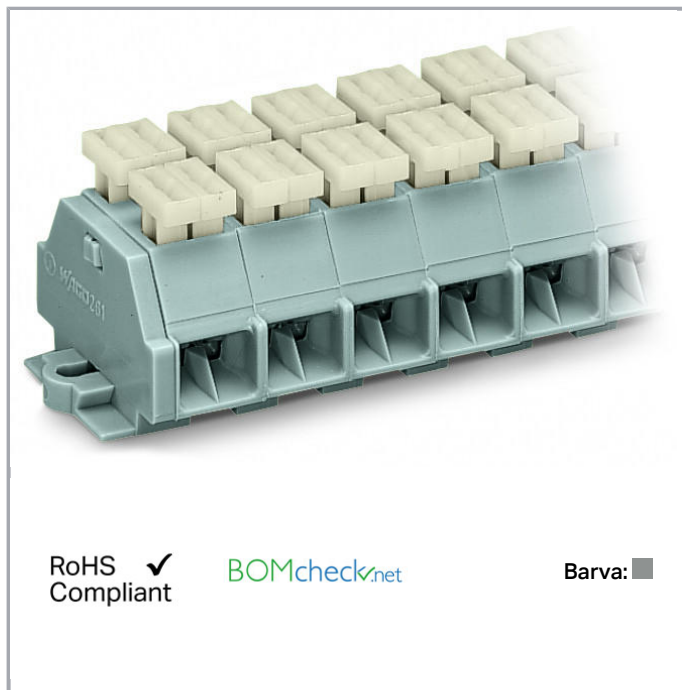

RoHS
Compliant

BOMcheck.net

Barva: ■

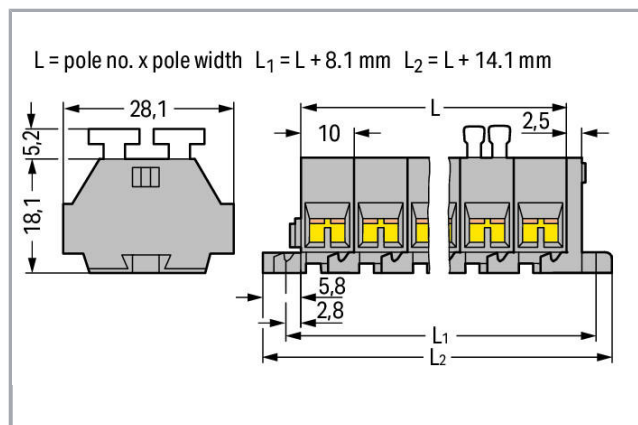

Data

Elektrické parametry

Ratings per IEC/EN 60664-1

Návrhové napětí (III / 3)	500 V
Návrhové rázové napětí (III / 3)	6 kV
Jmenovitý proud	24 A
Legenda (návrhové hodnoty)	(III / 3) ≙ kategorie přepětí III / stupeň znečištění 3

Údaje o připojení

Způsob ovládání	Push-button
-----------------	-------------

Geometrické údaje

Šířka modulu	10 mm / 0.394 inch
--------------	--------------------

Údaje o materiálu



barva	Šedá
-------	------

Obchodní údaje

Druh balení BOX

Atesty/certifikáty

Specifické atesty jednotlivých států

Logo	Schválení	Doplňkový text schválení	Název certifikátu
	CCA DEKRA Certification B.V.	EN 60998	NTR-NL 6509
	CCA DEKRA Certification B.V.	EN 60998	2110272.02

Atesty pro použití v lodním průmyslu

Logo	Schválení	Doplňkový text schválení	Název certifikátu
	ABS American Bureau of Shipping	-	19- HG1869868- PDA

Kompatibilní produkty

Jumper

	Obj. č.: 261-402 Vkládací můstek; Izolováno; 2x; Zmenšuje pripojiteľný prierez na 1,5 mm; Šedá	www.wago.com/261-402
--	--	--

tools









	Obj. č.: 209-132 Ovládací nástroj; K připojení vkládacího můstku; 2x; Z izolačního materiálu	www.wago.com/209-132
--	--	--







	Obj. č.: 210-657 Ovládací nástroj; Břit: 3,5 × 0,5 mm; S částečně izolovanou rukojetí; Krátké	www.wago.com/210-657
--	---	--

	Obj. č.: 210-658 Ovládací nástroj; Břit: 3,5 × 0,5 mm; S částečně izolovanou rukojetí; Úhlové provedení; Krátké	www.wago.com/210-658
--	---	--

	Obj. č.: 210-720 Ovládací nástroj; Břit: 3,5 × 0,5 mm; S částečně izolovanou rukojetí	www.wago.com/210-720
--	---	--

ferrule

	Obj. č.: 216-101 Dutinka; Objímka na 0,5 mm ² / AWG 22; Bez plastového límce; Galvanicky pocínováno	www.wago.com/216-101
	Obj. č.: 216-102 Dutinka; Objímka na 0,75 mm ² / AWG 20; Bez plastového límce; Galvanicky pocínováno	www.wago.com/216-102
	Obj. č.: 216-103 Dutinka; Objímka na 1 mm ² / AWG 18; Bez plastového límce; Galvanicky pocínováno	www.wago.com/216-103
	Obj. č.: 216-104 Dutinka; Objímka na 1,5 mm ² / AWG 16; Bez plastového límce; Galvanicky pocínováno	www.wago.com/216-104
	Obj. č.: 216-106 Dutinka; Objímka na 2,5 mm ² / AWG 14; Bez plastového límce; Galvanicky pocínováno	www.wago.com/216-106
	Obj. č.: 216-121 Dutinka; Objímka na 0,5 mm ² / AWG 22; Bez plastového límce; Galvanicky pocínováno	www.wago.com/216-121
	Obj. č.: 216-122 Dutinka; Objímka na 0,75 mm ² / AWG 20; Bez plastového límce; Galvanicky pocínováno	www.wago.com/216-122
	Obj. č.: 216-123 Dutinka; Objímka na 1 mm ² / AWG 18; Bez plastového límce; Galvanicky pocínováno	www.wago.com/216-123
	Obj. č.: 216-124 Dutinka; Objímka na 1,5 mm ² / AWG 16; Bez plastového límce; Galvanicky pocínováno	www.wago.com/216-124
	Obj. č.: 216-131 Dutinka; Objímka na 0,25 mm ² / AWG 24; Bez plastového límce; Galvanicky pocínováno	www.wago.com/216-131
	Obj. č.: 216-132 Dutinka; Objímka na 0,34 mm ² / AWG 24; Bez plastového límce; Galvanicky pocínováno	www.wago.com/216-132
	Obj. č.: 216-151 Dutinka; Objímka na 0,25 mm ² / AWG 24; Bez plastového límce; Galvanicky pocínováno	www.wago.com/216-151
	Obj. č.: 216-152 Dutinka; Objímka na 0,34 mm ² / AWG 24; Bez plastového límce; Galvanicky pocínováno	www.wago.com/216-152
	Obj. č.: 216-201 Ferrule; Sleeve for 0.5 mm ² / 20 AWG; insulated; electro-tin plated; white	www.wago.com/216-201
	Obj. č.: 216-202 Ferrule; Sleeve for 0.75 mm ² / 18 AWG; insulated; electro-tin plated; gray	www.wago.com/216-202
	Obj. č.: 216-203 Dutinka; Objímka na 1 mm ² / AWG 18; S plastovým límcem; Galvanicky pocínováno; Červená	www.wago.com/216-203
	Obj. č.: 216-204 Dutinka; Objímka na 1,5 mm ² / AWG 16; S plastovým límcem; Galvanicky pocínováno; Černá	www.wago.com/216-204
	Obj. č.: 216-205 Dutinka; Objímka na 2,08 mm ² / AWG 14; S plastovým límcem; Galvanicky pocínováno; Žlutá	www.wago.com/216-205
	Obj. č.: 216-206 Dutinka; Objímka na 2,5 mm ² / AWG 14; S plastovým límcem; Galvanicky pocínováno; Modrá	www.wago.com/216-206
	Obj. č.: 216-221 Ferrule; Sleeve for 0.5 mm ² / 20 AWG; insulated; electro-tin plated; white	www.wago.com/216-221

	Obj. č.: 216-222 Ferrule; Sleeve for 0.75 mm ² / 18 AWG; insulated; electro-tin plated; gray	www.wago.com/216-222
	Obj. č.: 216-223 Dutinka; Objímka na 1 mm ² / AWG 18; S plastovým límcem; Galvanicky pocínováno; Červená	www.wago.com/216-223
	Obj. č.: 216-224 Dutinka; Objímka na 1,5 mm ² / AWG 16; S plastovým límcem; Galvanicky pocínováno; Černá	www.wago.com/216-224
	Obj. č.: 216-301 Dutinka; Objímka na 0,25 mm ² / AWG 24; S plastovým límcem; Galvanicky pocínováno; Žlutá	www.wago.com/216-301
	Obj. č.: 216-302 Ferrule; Sleeve for 0.34 mm ² / 22 AWG; insulated; electro-tin plated; green	www.wago.com/216-302
	Obj. č.: 216-321 Dutinka; Objímka na 0,25 mm ² / AWG 24; S plastovým límcem; Galvanicky pocínováno; Žlutá	www.wago.com/216-321
	Obj. č.: 216-322 Ferrule; Sleeve for 0.34 mm ² / 22 AWG; insulated; electro-tin plated; green	www.wago.com/216-322
General accessories		
	Obj. č.: 209-123 Montážní patka se šroubem; Možnost přišroubování ke svorkám s upevňovací přírubou; Šířka 6,4 mm; Šedá	www.wago.com/209-123
assembling		
	Obj. č.: 209-137 Montážní adaptér; Lze použít jako koncovou svěrku; Šířka 6,5 mm; Šedá	www.wago.com/209-137

Ke stažení

Documentation

Additional Information

Technical explanations	03-Apr-2019	pdf 2,1 MB	Stáhnout
------------------------	-------------	---------------	----------

CAD/CAE-Data

CAD data

2D/3D Models 261-211/342-000	URL	Stáhnout
------------------------------	-----	----------

CAE data

EPLAN Data Portal 261-211/342-000	Stáhnout
-----------------------------------	----------

WSCAD Universe 261-211/342-000	Stáhnout
--------------------------------	----------



Handling Instructions

Změny vyhrazeny.

WAGO Elektro spol. sr. o.
Rozvodova 1116/36
143 00 Praha 12 - Modřany
Tel.: +420 261 090 143
Email: info.cz@wago.com, wago-cz@wago.com

Máte otázky ohledně našich produktů?
Kdykoli nám zavolejte na číslo +420 261 090 143.