

Datový list | Objednací číslo: 280-944/281-593

Svorka pro moduly; Dvoupatrová; S koncovou bočnicí; S diodou 1.5KE39CA TVS; AC 24 V; Na DIN lištu 35 × 15 a 35 × 7,5; 2,5 mm²; CAGE CLAMP®; 2,50 mm²; Šedá

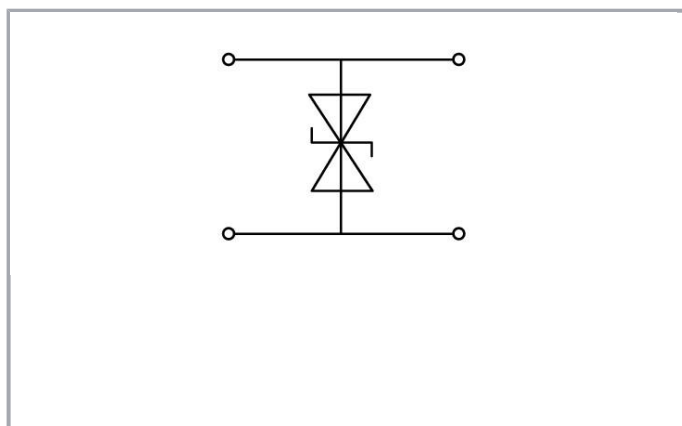

www.wago.com/280-944/281-593

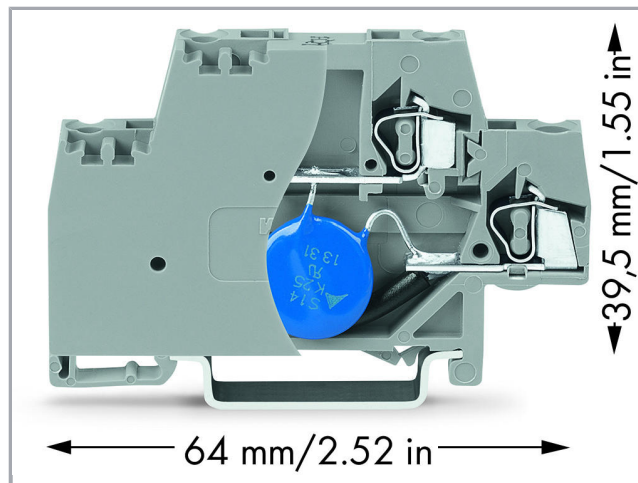
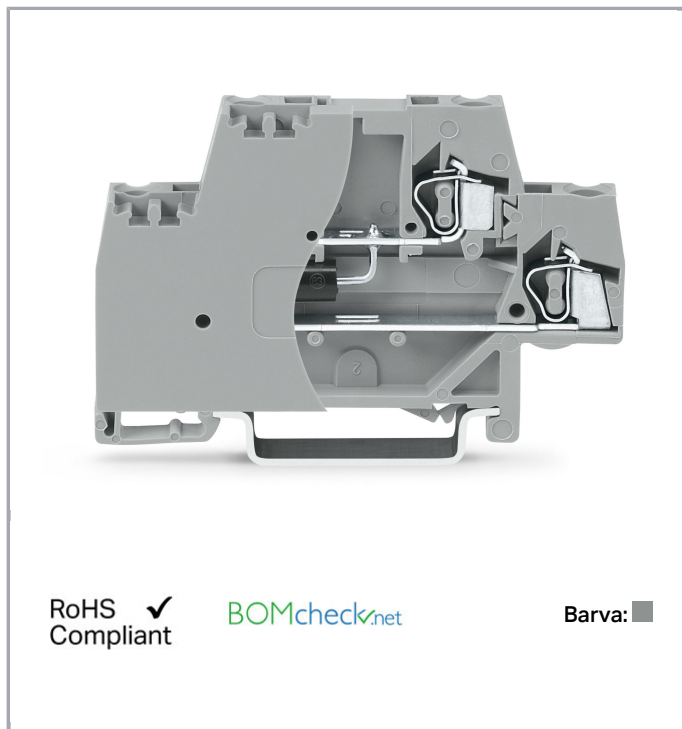

Popis položky

Short description:

Terminal blocks with surge suppression device and direct connection to the DIN-35 rail; these single-stage surge suppression devices are equipped either with 280 Series gas-filled surge arrester (coarse), varistor (medium) or suppressor diode (fine).

Features:

- Protect your system against overvoltage

—



- Slim, space-saving design
- Control operational costs by preventing expensive, unplanned downtime
- High operational reliability and system uptime

Data

Elektrické parametry

Nominal operating voltage	AC 24 V
Maximální nepřetržitě provozní napětí	AC 26 V
Jmenovitý proud (max.)	20 A
Nominal discharge current (8/20 µs) per line	143 A
Voltage protection level (8/20 µs)	≤ AC 70 V
Kapacita	≤ 2,4 nF

Údaje o připojení

Connections (number)	4
Připojovací technika	CAGE CLAMP®
Plný vodič	0,08 ... 2,5 mm ² / 28 ... 14 AWG
Jemně laněný vodič	0,08 ... 2,5 mm ² / 28 ... 14 AWG
Délka odizolování	8 ... 9 mm / 0.31 ... 0.35 palec

Geometrické údaje

Šířka	10 mm / 0.394 inch
Výška od horní hrany lišty DIN 35	39,5 mm / 1.555 inch
Hloubka	64 mm / 2.52 inch

Mechanické parametry

Provedení	With end plate
Způsob montáže	Lišta DIN 35

Údaje o materiálu



barva	Šedá
Hmotnost	14.182

Obchodní údaje

Product Group	1 (Rail Mounted Terminal Blocks)
Druh balení	BOX
Country of origin	DE
GTIN	4050821515036
Customs Tariff No.	85369010000

Kompatibilní produkty









Insulation stop

	Obj. č.: 280-470 Izolační zarážka; 0,08–0,2 mm ² „e“ (0,14 mm ² „f“); 5 ks/pás; Bílá	www.wago.com/280-470
	Obj. č.: 280-471 Izolační zarážka; 0,25–0,5 mm ² ; 5 ks/pás; Světle šedá	www.wago.com/280-471
	Obj. č.: 280-472 Izolační zarážka; 0,75–1 mm ² ; 5 ks/pás	www.wago.com/280-472

tools

	Obj. č.: 210-720 Ovládací nástroj; Břit: 3,5 × 0,5 mm; S částečně izolovanou rukojetí	www.wago.com/210-720
----------------------------------------------------------------------------------	-------------------------------------------------------------------------------------------------	----------------------------------------------------------------

Marking accessories

	Obj. č.: 2009-145 Mini-WSB Inline; Pro Smart Printer; Na cívce; Flexibilní, 5–5,2 mm; Bez potisku; Možnost naklapnutí; Bílá	www.wago.com/2009-145
	Obj. č.: 2009-145/000-002 Mini-WSB Inline; Pro Smart Printer; Na cívce; Flexibilní, 5–5,2 mm; Bez potisku; Možnost naklapnutí; Žlutá /000-002	www.wago.com/2009-145/000-002
	Obj. č.: 2009-145/000-005 Mini-WSB Inline; Pro Smart Printer; Na cívce; Flexibilní, 5–5,2 mm; Bez potisku; Možnost naklapnutí; Červená	www.wago.com/2009-145/000-005
	Obj. č.: 2009-145/000-006 Mini-WSB Inline; Pro Smart Printer; Na cívce; Flexibilní, 5–5,2 mm; Bez potisku; Možnost naklapnutí; Modrá	www.wago.com/2009-145/000-006
	Obj. č.: 2009-145/000-007 Mini-WSB Inline; Pro Smart Printer; Na cívce; Flexibilní, 5–5,2 mm; Bez potisku; Možnost naklapnutí; Šedá /000-007	www.wago.com/2009-145/000-007
	Obj. č.: 2009-145/000-012 Mini-WSB Inline; Pro Smart Printer; Na cívce; Flexibilní, 5–5,2 mm; Bez potisku; Možnost naklapnutí; Oranžová	www.wago.com/2009-145/000-012
	Obj. č.: 2009-145/000-023 Mini-WSB Inline; Pro Smart Printer; Na cívce; Flexibilní, 5–5,2 mm; Bez potisku; Možnost naklapnutí; Zelená	www.wago.com/2009-145/000-023
	Obj. č.: 2009-145/000-024 Mini-WSB Inline; Pro Smart Printer; Na cívce; Flexibilní, 5–5,2 mm; Bez potisku; Možnost naklapnutí; Fialová	www.wago.com/2009-145/000-024
	Obj. č.: 248-501 Systém rychlého popisování Mini-WSB; Bez potisku; Šířka štítků 5 mm; 10 řad po 10 štítcích na každé kartě	www.wago.com/248-501



Obj. č.: 248-501/000-002

Popisovací karta Mini-WSB; Jako karta; Neflexibilní; Bez potisku; Možnost naklapnutí; Žlutá

www.wago.com/248-501/000-002



Obj. č.: 248-501/000-005

Popisovací karta Mini-WSB; Jako karta; Neflexibilní; Bez potisku; Možnost naklapnutí; Červená

www.wago.com/248-501/000-005



Obj. č.: 248-501/000-006

Popisovací karta Mini-WSB; Jako karta; Neflexibilní; Bez potisku; Možnost naklapnutí; Modrá

www.wago.com/248-501/000-006



Obj. č.: 248-501/000-007

Popisovací karta Mini-WSB; Jako karta; Neflexibilní; Bez potisku; Možnost naklapnutí; Šedá

www.wago.com/248-501/000-007



Obj. č.: 248-501/000-012

Popisovací karta Mini-WSB; Jako karta; Neflexibilní; Bez potisku; Možnost naklapnutí; Oranžová

www.wago.com/248-501/000-012



Obj. č.: 248-501/000-017

Popisovací karta Mini-WSB; Jako karta; Neflexibilní; Bez potisku; Možnost naklapnutí; Světle zelená

www.wago.com/248-501/000-017



Obj. č.: 248-501/000-023

Popisovací karta Mini-WSB; Jako karta; Neflexibilní; Bez potisku; Možnost naklapnutí; Zelená

www.wago.com/248-501/000-023



Obj. č.: 248-501/000-024

Popisovací karta Mini-WSB; Jako karta; Neflexibilní; Bez potisku; Možnost naklapnutí; Fialová

www.wago.com/248-501/000-024

Jumper



Obj. č.: 280-482

Hřebenový můstek; Izolováno; 2x; IN = IN svorky; Šedá

www.wago.com/280-482



Obj. č.: 280-483

Hřebenový můstek; Izolováno; 3x; IN = IN svorky; Šedá

www.wago.com/280-483



Obj. č.: 280-484

Hřebenový můstek; Izolováno; 4x; IN = IN svorky; Šedá

www.wago.com/280-484



Obj. č.: 280-485

Hřebenový můstek; Izolováno; 5x; IN = IN svorky; Šedá

www.wago.com/280-485



Obj. č.: 280-490

Hřebenový můstek; Izolováno; 10x; IN = IN svorky; Šedá

www.wago.com/280-490



Obj. č.: 280-492

Hřebenový můstek ob svorku; Izolováno; 2x; IN = IN svorky; Šedá

www.wago.com/280-492

Ke stažení

Documentation

Additional Information

Disposal; Electrical and electronic equipment, Packaging



V 1.0.0

pdf
265,8 kB

Stáhnout

CAD/CAE-Data

CAE data

EPLAN Data Portal 280-944/281-593

Stáhnout

WSCAD Universe 280-944/281-593

Stáhnout

Handling Instructions

Změny vyhrazeny.

WAGO Elektro spol. sr. o.
Rozvodova 1116/36
143 00 Praha 12 - Modřany
Tel.: +420 261 090 143
Email: info.cz@wago.com, wago-cz@wago.com

Máte otázky ohledně našich produktů?
Kdykoli nám zavolejte na číslo +420 261 090 143.