

Datový list | Objednací číslo: 280-504/281-586

Svorka pro moduly; Dvoupatrová; S koncovou bočnicí; S varistorem; Na DIN lištu 35 × 15 a 35 × 7,5; 2,5 mm<sup>2</sup>; CAGE CLAMP®; 2,50 mm<sup>2</sup>; Šedá

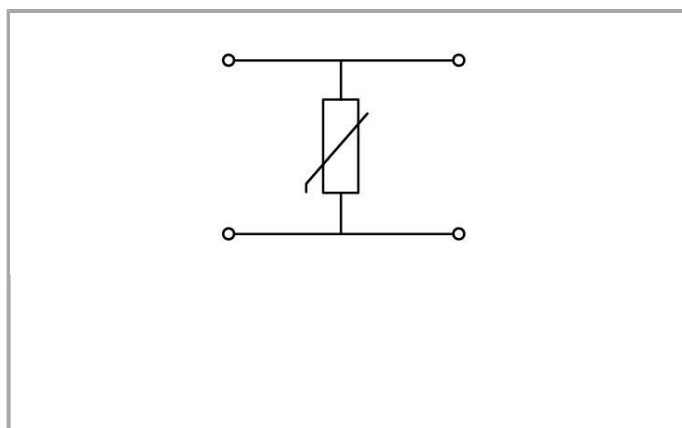

[www.wago.com/280-504/281-586](http://www.wago.com/280-504/281-586)

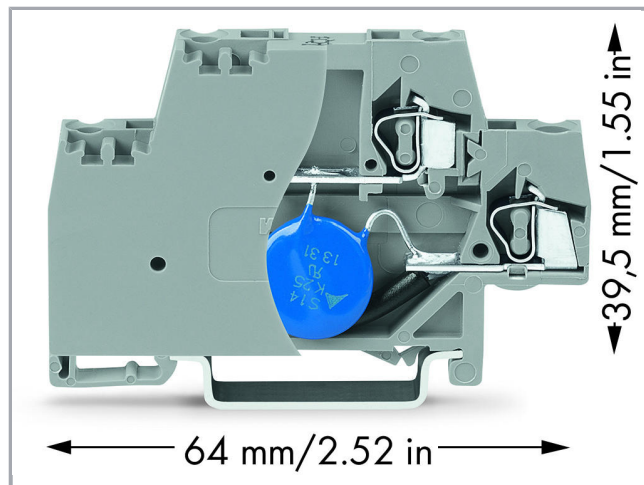
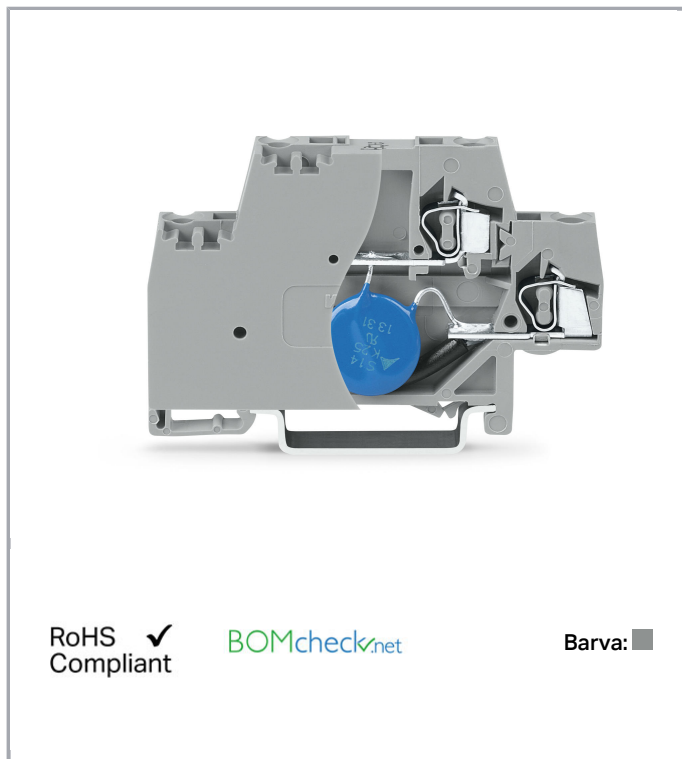

### Popis položky

#### Short description:

Terminal blocks with surge suppression device and direct connection to the DIN-35 rail; these single-stage surge suppression devices are equipped either with 280 Series gas-filled surge arrester (coarse), varistor (medium) or suppressor diode (fine).

#### Features:

—



- Protect your system against overvoltage
- Slim, space-saving design
- Control operational costs by preventing expensive, unplanned downtime
- High operational reliability and system uptime

## Data

### Elektrické parametry

Nominal operating voltage	AC 24 V
Maximální nepřetržitě provozní napětí	AC 30 V
Jmenovitý proud (max.)	20 A
Nominal discharge current (8/20 $\mu$ s) per line	300 A
Max. svodový rázový proud (8/20 $\mu$ s) $I_{max}$	1 kA
Voltage protection level (8/20 $\mu$ s)	$\leq$ AC 93 V
Response time line/line	$\leq$
Kapacita	$\leq$ 3,5 nF

### Údaje o připojení

Connections (number)	4
Připojovací technika	CAGE CLAMP®
Plný vodič	0,08 ... 2,5 mm <sup>2</sup> / 28 ... 14 AWG
Jemně laněný vodič	0,08 ... 2,5 mm <sup>2</sup> / 28 ... 14 AWG
Délka odizolování	8 ... 9 mm / 0.31 ... 0.35 palec

### Geometrické údaje

Šířka	10 mm / 0.394 inch
Výška od horní hrany lišty DIN 35	39,5 mm / 1.555 inch
Hloubka	64 mm / 2.52 inch

### Mechanické parametry

Provedení	With end plate
Způsob montáže	Lišta DIN 35

### Údaje o materiálu

barva	Šedá
Hmotnost	15.489

### Obchodní údaje

Product Group	1 (Rail Mounted Terminal Blocks)
Druh balení	BOX

Country of origin	DE
GTIN	4045454921972
Customs Tariff No.	85369010000

## Kompatibilní produkty







### Jumper















	<b>Obj. č.: 280-482</b> Hřebenový můstek; Izolováno; 2×; IN = IN svorky; Šedá	<a href="http://www.wago.com/280-482">www.wago.com/280-482</a>
	<b>Obj. č.: 280-483</b> Hřebenový můstek; Izolováno; 3×; IN = IN svorky; Šedá	<a href="http://www.wago.com/280-483">www.wago.com/280-483</a>
	<b>Obj. č.: 280-484</b> Hřebenový můstek; Izolováno; 4×; IN = IN svorky; Šedá	<a href="http://www.wago.com/280-484">www.wago.com/280-484</a>
	<b>Obj. č.: 280-485</b> Hřebenový můstek; Izolováno; 5×; IN = IN svorky; Šedá	<a href="http://www.wago.com/280-485">www.wago.com/280-485</a>
	<b>Obj. č.: 280-490</b> Hřebenový můstek; Izolováno; 10×; IN = IN svorky; Šedá	<a href="http://www.wago.com/280-490">www.wago.com/280-490</a>
	<b>Obj. č.: 280-492</b> Hřebenový můstek ob svorku; Izolováno; 2×; IN = IN svorky; Šedá	<a href="http://www.wago.com/280-492">www.wago.com/280-492</a>

### tools

	<b>Obj. č.: 210-720</b> Ovládací nástroj; Břit: 3,5 × 0,5 mm; S částečně izolovanou rukojetí	<a href="http://www.wago.com/210-720">www.wago.com/210-720</a>
--	---	--

### Marking accessories

	<b>Obj. č.: 2009-145</b> Mini-WSB Inline; Pro Smart Printer; Na cívce; Flexibilní, 5–5,2 mm; Bez potisku; Možnost naklapnutí; Bílá	<a href="http://www.wago.com/2009-145">www.wago.com/2009-145</a>
	<b>Obj. č.: 2009-145/000-002</b> Mini-WSB Inline; Pro Smart Printer; Na cívce; Flexibilní, 5–5,2 mm; Bez potisku; Možnost naklapnutí; Žlutá /000-002	<a href="http://www.wago.com/2009-145">www.wago.com/2009-145</a>
	<b>Obj. č.: 2009-145/000-005</b> Mini-WSB Inline; Pro Smart Printer; Na cívce; Flexibilní, 5–5,2 mm; Bez potisku; Možnost naklapnutí; Červená	<a href="http://www.wago.com/2009-145">www.wago.com/2009-145</a> /000-005
	<b>Obj. č.: 2009-145/000-006</b> Mini-WSB Inline; Pro Smart Printer; Na cívce; Flexibilní, 5–5,2 mm; Bez potisku; Možnost naklapnutí; Modrá	<a href="http://www.wago.com/2009-145">www.wago.com/2009-145</a> /000-006
	<b>Obj. č.: 2009-145/000-007</b> Mini-WSB Inline; Pro Smart Printer; Na cívce; Flexibilní, 5–5,2 mm; Bez potisku; Možnost naklapnutí; Šedá /000-007	<a href="http://www.wago.com/2009-145">www.wago.com/2009-145</a>
	<b>Obj. č.: 2009-145/000-012</b> Mini-WSB Inline; Pro Smart Printer; Na cívce; Flexibilní, 5–5,2 mm; Bez potisku; Možnost naklapnutí; Oranžová	<a href="http://www.wago.com/2009-145">www.wago.com/2009-145</a> /000-012

	<b>Obj. č.: 2009-145/000-023</b> Mini-WSB Inline; Pro Smart Printer; Na cívce; Flexibilní, 5–5,2 mm; Bez potisku; Možnost naklapnutí; Zelená	<a href="http://www.wago.com/2009-145/000-023">www.wago.com/2009-145/000-023</a>
	<b>Obj. č.: 2009-145/000-024</b> Mini-WSB Inline; Pro Smart Printer; Na cívce; Flexibilní, 5–5,2 mm; Bez potisku; Možnost naklapnutí; Fialová	<a href="http://www.wago.com/2009-145/000-024">www.wago.com/2009-145/000-024</a>
	<b>Obj. č.: 248-501</b> Systém rychlého popisování Mini-WSB; Bez potisku; Šířka štítků 5 mm; 10 řad po 10 štítcích na každé kartě	<a href="http://www.wago.com/248-501">www.wago.com/248-501</a>
	<b>Obj. č.: 248-501/000-002</b> Popisovací karta Mini-WSB; Jako karta; Neflexibilní; Bez potisku; Možnost naklapnutí; Žlutá	<a href="http://www.wago.com/248-501/000-002">www.wago.com/248-501/000-002</a>
	<b>Obj. č.: 248-501/000-005</b> Popisovací karta Mini-WSB; Jako karta; Neflexibilní; Bez potisku; Možnost naklapnutí; Červená	<a href="http://www.wago.com/248-501/000-005">www.wago.com/248-501/000-005</a>
	<b>Obj. č.: 248-501/000-006</b> Popisovací karta Mini-WSB; Jako karta; Neflexibilní; Bez potisku; Možnost naklapnutí; Modrá	<a href="http://www.wago.com/248-501/000-006">www.wago.com/248-501/000-006</a>
	<b>Obj. č.: 248-501/000-007</b> Popisovací karta Mini-WSB; Jako karta; Neflexibilní; Bez potisku; Možnost naklapnutí; Šedá	<a href="http://www.wago.com/248-501/000-007">www.wago.com/248-501/000-007</a>
	<b>Obj. č.: 248-501/000-012</b> Popisovací karta Mini-WSB; Jako karta; Neflexibilní; Bez potisku; Možnost naklapnutí; Oranžová	<a href="http://www.wago.com/248-501/000-012">www.wago.com/248-501/000-012</a>
	<b>Obj. č.: 248-501/000-017</b> Popisovací karta Mini-WSB; Jako karta; Neflexibilní; Bez potisku; Možnost naklapnutí; Světle zelená	<a href="http://www.wago.com/248-501/000-017">www.wago.com/248-501/000-017</a>
	<b>Obj. č.: 248-501/000-023</b> Popisovací karta Mini-WSB; Jako karta; Neflexibilní; Bez potisku; Možnost naklapnutí; Zelená	<a href="http://www.wago.com/248-501/000-023">www.wago.com/248-501/000-023</a>
	<b>Obj. č.: 248-501/000-024</b> Popisovací karta Mini-WSB; Jako karta; Neflexibilní; Bez potisku; Možnost naklapnutí; Fialová	<a href="http://www.wago.com/248-501/000-024">www.wago.com/248-501/000-024</a>
<b>Insulation stop</b>		
	<b>Obj. č.: 280-470</b> Izolační zarážka; 0,08–0,2 mm <sup>2</sup> „e“ (0,14 mm <sup>2</sup> „f“); 5 ks/pás; Bílá	<a href="http://www.wago.com/280-470">www.wago.com/280-470</a>
	<b>Obj. č.: 280-471</b> Izolační zarážka; 0,25–0,5 mm <sup>2</sup> ; 5 ks/pás; Světle šedá	<a href="http://www.wago.com/280-471">www.wago.com/280-471</a>
	<b>Obj. č.: 280-472</b> Izolační zarážka; 0,75–1 mm <sup>2</sup> ; 5 ks/pás	<a href="http://www.wago.com/280-472">www.wago.com/280-472</a>

## Ke stažení

### Documentation

#### Additional Information

Disposal; Electrical and electronic equipment, Packaging	V 1.0.0	pdf 265,8 kB	Stáhnout
--	---------	-----------------	----------

---

### CAD/CAE-Data

#### CAD data

2D/3D Models 280-504/281-586	URL	Stáhnout
------------------------------	-----	----------

---

#### CAE data

EPLAN Data Portal 280-504/281-586	Stáhnout
-----------------------------------	----------

---

WSCAD Universe 280-504/281-586	Stáhnout
--------------------------------	----------

---

## Handling Instructions

Změny vyhrazeny.

---

WAGO Elektro spol. sr. o.  
Rozvodova 1116/36  
143 00 Praha 12 - Modřany  
Tel.: +420 261 090 143  
Email: [info.cz@wago.com](mailto:info.cz@wago.com), [wago-cz@wago.com](mailto:wago-cz@wago.com)

Máte otázky ohledně našich produktů?  
Kdykoli nám zavolejte na číslo +420 261 090 143.