

Datenblatt | Artikelnummer: 2006-8671

2-Leiter-Trenn- und Messklemme; mit schwenkbarem Trennmesser; mit Prüfmöglichkeit; Trennmesserhalter orange; für Tragschiene 35 x 15 und 35 x 7,5; 6 mm²; Push-in CAGE CLAMP®; 6,00 mm²; grau

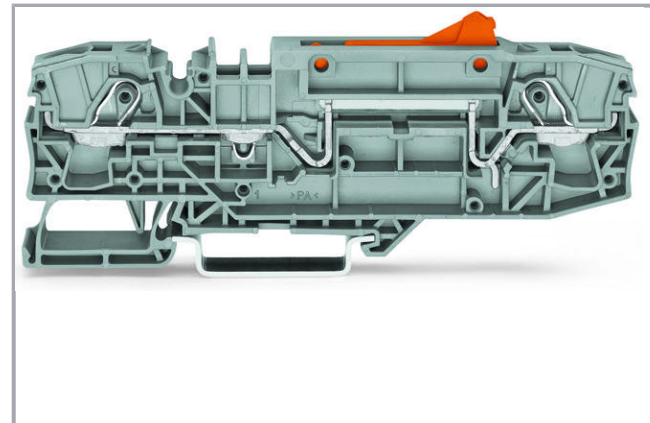

www.wago.com/2006-8671

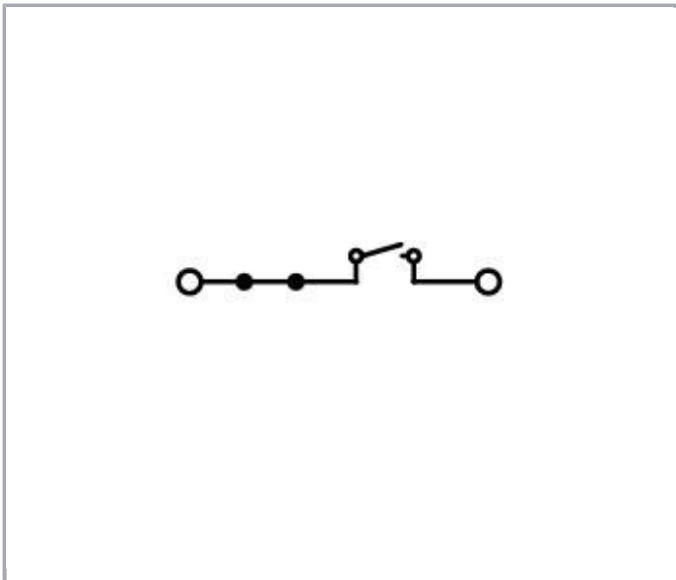
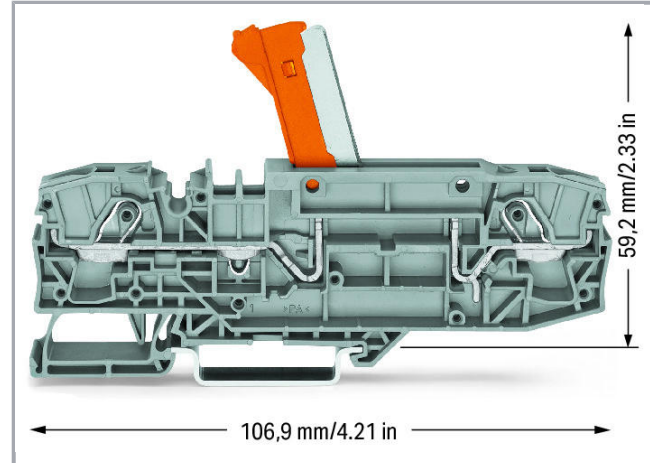
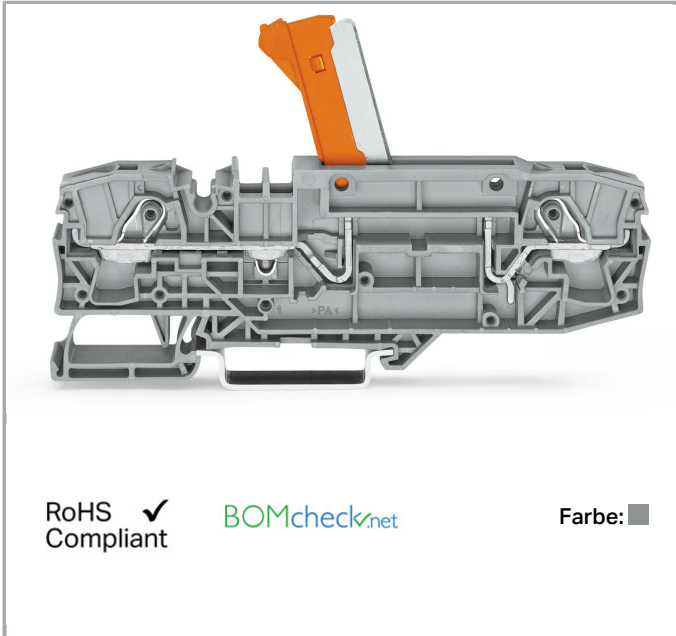

Daten

Elektrische Daten

Art der Spannung 1	AC/DC
Art der Spannung 2	DC

Bemessungsdaten gemäß IEC/EN 60664-1

Bemessungsspannung (III / 3)	1000 V
Bemessungsstoßspannung (III / 3)	12 kV
Bemessungsstrom	30 A
Bemessungsspannung (III / 3) 2	1500 V
Bemessungsstoßspannung (III / 3) 2	12 kV
Legende Bemessungsdaten	(III / 3) \triangleq Überspannungskategorie III / Verschmutzungsgrad 3

Bemessungsdaten gemäß UL 1059

Bemessungsspannung UL (Use Group B)	600 V
Bemessungsstrom UL (Use Group B)	30 A
Bemessungsspannung UL (Use Group C)	600 V
Bemessungsstrom UL (Use Group C)	30 A

Bemessungsdaten gemäß CSA

Bemessungsspannung CSA (Use Group B)	600 V
Bemessungsstrom CSA (Use Group B)	30 A
Bemessungsspannung CSA (Use Group C)	1000 V
Bemessungsstrom CSA (Use Group C)	30 A

Anschlussdaten

Anschluss technik	Push-in CAGE CLAMP®
Betätigungsart	Push-in Betätigungswerkzeug
Anschließbare Leiterwerkstoffe	Kupfer
Nennquerschnitt	6 mm ²
Eindrätiger Leiter	0,5 ... 10 mm ² / 20 ... 8 AWG
Eindrätiger Leiter; direkt steckbar	2,5 ... 10 mm ² / 14 ... 8 AWG
Feindrätiger Leiter	0,5 ... 10 mm ² / 20 ... 8 AWG
Feindrätiger Leiter; mit Aderendhülse, direkt steckbar ab	2,5 mm ² / 16 AWG
Abisolierlänge	13 ... 15 mm / 0.51 ... 0.59 inch
Gesamte Anzahl der Klemmstellen	2
Gesamte Anzahl der Potentiale	1
Anzahl der Ebenen	1
Verdrahtungsart	Frontverdrahtung
Hinweis (Leiterquerschnitt)	Je nach Beschaffenheit des Leiters kann auch ein Leiter geringeren Querschnitts direkt steckbar sein.
Anzahl Brückeraufnahmen	2

Geometrische Daten

Breite	15 mm / 0.591 inch
Höhe ab Oberkante Tragschiene	33 mm / 1.299 inch
Tiefe	106,9 mm / 4.209 inch

Mechanische Daten

Bauform	horizontale Bauform
Montageart	Tragschiene 35
Beschriftungsebene	Mitten-/Seitliche Beschriftung

Werkstoffdaten



Farbe	grau
Isolierwerkstoff	Polyamid 66 (PA 66)
Brandlast	0.673 MJ
Gewicht	31.425 g

Kaufmännische Daten



Produktgruppe	22 (TOPJOB S Reihenklemmen)
eCl@ss 10.0	27-14-11-26
eCl@ss 9.0	27-14-11-26
ETIM 7.0	EC000902
ETIM 6.0	EC000902
Verpackungsart	Karton
Ursprungsland	DE
GTIN	4050821372509
Zolltarifnummer	85365080900

Zulassungen / Zertifikate

Länderspezifische Zulassungen

Logo	Zulassung	Norm	Zertifikatsname
	CCA DEKRA Certification B.V.	IEC 60947	NTR NL 7311
	CCA DEKRA Certification B.V.	IEC 60947	71-101179
	CSA DEKRA Certification B.V.	C22.2 No. 158	1543858

Schiff Zulassungen



Logo	Zulassung	Norm	Zertifikatsname
	ABS American Bureau of Shipping	EN 60947	14- HG1293677- PDA
	DNV GL Det Norske Veritas, Germanischer Lloyd	-	TAE00001V2

UL-Zulassungen



Logo	Zulassung	Norm	Zertifikatsname
	UL Underwriters Laboratories Inc.	UL 1059	E45172

Passende Produkte

Abschlussplatte

	Art-Nr.: 2006-8691 Abschluss- und Zwischenplatte; 1 mm dick; grau	www.wago.com/2006-8691
	Art-Nr.: 2006-8692 Abschluss- und Zwischenplatte; 1 mm dick; orange	www.wago.com/2006-8692











Prüfen und Messen

	Art-Nr.: 2009-174 Prüfadapter; für Prüfstecker Ø 4 mm; zur Prüfung von TOPJOB®S-Reihenklammern; grau	www.wago.com/2009-174
	Art-Nr.: 2009-182 Prüfabgriff; für max. 2,5 mm ² ; für den werkzeuglosen Anschluss individueller Prüfleitungen von 0,08 mm - 2,5 mm; grau	www.wago.com/2009-182
	Art-Nr.: 210-136 Prüfstecker; Ø 2 mm; mit 500mm-Leitung; rot	www.wago.com/210-136

Werkzeug

	Art-Nr.: 210-721 Betätigungswerkzeug; Klinge 5,5 x 0,8 mm; mit teilisoliertem Schaft	www.wago.com/210-721
--	--	--





Tragschiene

	Art-Nr.: 210-112 Stahltragschiene; 35 x 7,5 mm; 1 mm dick; 2 m lang; gelocht; entsprechend EN 60715; Lochbreite 25 mm; Lochabstand 36 mm	www.wago.com/210-112
	Art-Nr.: 210-113 Stahltragschiene; 35 x 7,5 mm; 1 mm dick; 2 m lang; ungelocht; entsprechend EN 60715	www.wago.com/210-113
	Art-Nr.: 210-114 Stahltragschiene; 35 x 15 mm; 1,5 mm dick; 2 m lang; ungelocht; ähnlich EN 60715	www.wago.com/210-114
	Art-Nr.: 210-115 Stahltragschiene; 35 x 7,5 mm; 1 mm dick; 2 m lang; gelocht; entsprechend EN 60715; Lochbreite 18 mm; Lochabstand 25 mm	www.wago.com/210-115
	Art-Nr.: 210-118 Stahltragschiene; 35 x 15 mm; 2,3 mm dick; 2 m lang; ungelocht; entsprechend EN 60715	www.wago.com/210-118
	Art-Nr.: 210-196 Aluminiumtragschiene; 35 x 8,2 mm; 1,6 mm dick; 2 m lang; ungelocht; ähnlich EN 60715; silberfarben	www.wago.com/210-196
	Art-Nr.: 210-197 Stahltragschiene; 35 x 15 mm; 1,5 mm dick; 2 m lang; gelocht; ähnlich EN 60715	www.wago.com/210-197
	Art-Nr.: 210-198 Kupfertragschiene; 35 x 15 mm; 2,3 mm dick; 2 m lang; ungelocht; entsprechend EN 60715; kupferfarben	www.wago.com/210-198
	Art-Nr.: 210-504 Stahltragschiene; 35 x 7,5 mm; 1 mm dick; 2 m lang; gelocht; bandverzinkt; entsprechend EN 60715	www.wago.com/210-504
	Art-Nr.: 210-505 Stahltragschiene; 35 x 7,5 mm; 1 mm dick; 2 m lang; ungelocht; bandverzinkt; entsprechend EN 60715	www.wago.com/210-505
	Art-Nr.: 210-506 Stahltragschiene; 35 x 15 mm; 1,5 mm dick; 2 m lang; ungelocht; bandverzinkt; ähnlich EN 60715	www.wago.com/210-506
	Art-Nr.: 210-508 Stahltragschiene; 35 x 15 mm; 1,5 mm dick; 2 m lang; gelocht; bandverzinkt; ähnlich EN 60715	www.wago.com/210-508

Warnabdeckung

	Art-Nr.: 2006-115 Warnabdeckung; mit schwarzem Blitzpfeil; für 5 Klemmen; gelb	www.wago.com/2006-115
--	--	--

Aderendhülse

	Art-Nr.: 216-208 Aderendhülse; Hülse für 6 mm ² / AWG 10; mit Kunststoffkragen; galvanisch verzinkt; Elektrolytkupfer; gasdicht aufgecrimpt; gemäß DIN 46228, Teil 4/09.90; gelb	www.wago.com/216-208
	Art-Nr.: 216-262 Aderendhülse; Hülse für 0,75 mm ² / AWG 18; mit Kunststoffkragen; galvanisch verzinkt; Elektrolytkupfer; gasdicht aufgecrimpt; gemäß DIN 46228, Teil 4/09.90; grau	www.wago.com/216-262
	Art-Nr.: 216-263 Aderendhülse; Hülse für 1 mm ² / AWG 18; mit Kunststoffkragen; galvanisch verzinkt; Elektrolytkupfer; gasdicht aufgecrimpt; gemäß DIN 46228, Teil 4/09.90; rot	www.wago.com/216-263
	Art-Nr.: 216-264 Aderendhülse; Hülse für 1,5 mm ² / AWG 16; mit Kunststoffkragen; galvanisch verzinkt; Elektrolytkupfer; gasdicht aufgecrimpt; gemäß DIN 46228, Teil 4/09.90; schwarz	www.wago.com/216-264
	Art-Nr.: 216-266	

	Aderendhülse; Hülse für 2,5 mm ² / AWG 14; mit Kunststoffkragen; galvanisch verzinkt; Elektrolytkupfer; gasdicht aufgedrimpt; gemäß DIN 46228, Teil 4/09.90; blau	www.wago.com/216-266
--	--	--

	Art-Nr.: 216-267 Aderendhülse; Hülse für 4 mm ² / AWG 12; mit Kunststoffkragen; galvanisch verzinkt; Elektrolytkupfer; gasdicht aufgedrimpt; gemäß DIN 46228, Teil 4/09.90; grau	www.wago.com/216-267
--	---	--

Allgemeines Zubehör

	Art-Nr.: 2002-121 Adapter	www.wago.com/2002-121
--	-------------------------------------	--

	Art-Nr.: 2006-191 Verschlusskappe; Signalverteiler; grau	www.wago.com/2006-191
--	--	--

Beschriftungsmaterial

	Art-Nr.: 2009-110 Beschriftungsstreifen; auf Rolle; nicht dehnbar; unbedruckt; aufrastbar; weiß	www.wago.com/2009-110
--	---	--

	Art-Nr.: 2009-115 WMB-Inline; für Smart Printer; auf Rolle; dehnbar 5 - 5,2 mm; unbedruckt; aufrastbar; weiß	www.wago.com/2009-115
--	--	--

	Art-Nr.: 2009-115/000-002 WMB-Inline; für Smart Printer; auf Rolle; dehnbar 5 - 5,2 mm; unbedruckt; aufrastbar; gelb	www.wago.com/2009-115/000-002
--	--	--

	Art-Nr.: 2009-115/000-006 WMB-Inline; für Smart Printer; auf Rolle; dehnbar 5 - 5,2 mm; unbedruckt; aufrastbar; blau	www.wago.com/2009-115/000-006
---	--	--

	Art-Nr.: 2009-115/000-007 WMB-Inline; für Smart Printer; auf Rolle; dehnbar 5 - 5,2 mm; unbedruckt; aufrastbar; grau	www.wago.com/2009-115/000-007
--	--	--

	Art-Nr.: 2009-115/000-012 WMB-Inline; für Smart Printer; auf Rolle; dehnbar 5 - 5,2 mm; unbedruckt; aufrastbar; orange	www.wago.com/2009-115/000-012
--	--	--

	Art-Nr.: 2009-115/000-017 WMB-Inline; für Smart Printer; auf Rolle; dehnbar 5 - 5,2 mm; unbedruckt; aufrastbar; hellgrün	www.wago.com/2009-115/000-017
--	--	--

















	Art-Nr.: 2009-115/000-023 WMB-Inline; für Smart Printer; auf Rolle; dehnbar 5 - 5,2 mm; unbedruckt; aufrastbar; grün	www.wago.com/2009-115/000-023
--	--	--















	Art-Nr.: 2009-115/000-024 WMB-Inline; für Smart Printer; auf Rolle; dehnbar 5 - 5,2 mm; unbedruckt; aufrastbar; violett	www.wago.com/2009-115/000-024
--	---	--

	Art-Nr.: 2009-145 Mini-WSB Inline; für Smart Printer; auf Rolle; dehnbar 5 - 5,2 mm; unbedruckt; aufrastbar; weiß	www.wago.com/2009-145
--	---	--

	Art-Nr.: 2009-145/000-002 Mini-WSB Inline; für Smart Printer; auf Rolle; dehnbar 5 - 5,2 mm; unbedruckt; aufrastbar; gelb	www.wago.com/2009-145/000-002
--	---	--

	Art-Nr.: 2009-145/000-005 Mini-WSB Inline; für Smart Printer; auf Rolle; dehnbar 5 - 5,2 mm; unbedruckt; aufrastbar; rot	www.wago.com/2009-145/000-005
--	--	--

	Art-Nr.: 2009-145/000-006 Mini-WSB Inline; für Smart Printer; auf Rolle; dehnbar 5 - 5,2 mm; unbedruckt; aufrastbar; blau	www.wago.com/2009-145/000-006
	Art-Nr.: 2009-145/000-007 Mini-WSB Inline; für Smart Printer; auf Rolle; dehnbar 5 - 5,2 mm; unbedruckt; aufrastbar; grau	www.wago.com/2009-145/000-007
	Art-Nr.: 2009-145/000-012 Mini-WSB Inline; für Smart Printer; auf Rolle; dehnbar 5 - 5,2 mm; unbedruckt; aufrastbar; orange	www.wago.com/2009-145/000-012
	Art-Nr.: 2009-145/000-023 Mini-WSB Inline; für Smart Printer; auf Rolle; dehnbar 5 - 5,2 mm; unbedruckt; aufrastbar; grün	www.wago.com/2009-145/000-023
	Art-Nr.: 2009-145/000-024 Mini-WSB Inline; für Smart Printer; auf Rolle; dehnbar 5 - 5,2 mm; unbedruckt; aufrastbar; violett	www.wago.com/2009-145/000-024
	Art-Nr.: 2009-191 Gruppenschildträger	www.wago.com/2009-191
	Art-Nr.: 2009-192 Gruppenschildträger	www.wago.com/2009-192
	Art-Nr.: 2009-193 Gruppenschildträger	www.wago.com/2009-193
	Art-Nr.: 2009-198 Adapter	www.wago.com/2009-198
	Art-Nr.: 248-501 Mini-WSB-Schnellbeschriftungssystem; unbedruckt; Schildchenbreite 5 mm; 10 Streifen à 10 Schilder pro Karte	www.wago.com/248-501
	Art-Nr.: 248-501/000-002 Mini-WSB-Beschriftungskarte; als Karte; nicht dehnbar; unbedruckt; aufrastbar; gelb	www.wago.com/248-501/000-002
	Art-Nr.: 248-501/000-005 Mini-WSB-Beschriftungskarte; als Karte; nicht dehnbar; unbedruckt; aufrastbar; rot	www.wago.com/248-501/000-005
	Art-Nr.: 248-501/000-006 Mini-WSB-Beschriftungskarte; als Karte; nicht dehnbar; unbedruckt; aufrastbar; blau	www.wago.com/248-501/000-006
	Art-Nr.: 248-501/000-007 Mini-WSB-Beschriftungskarte; als Karte; nicht dehnbar; unbedruckt; aufrastbar; grau	www.wago.com/248-501/000-007
	Art-Nr.: 248-501/000-012 Mini-WSB-Beschriftungskarte; als Karte; nicht dehnbar; unbedruckt; aufrastbar; orange	www.wago.com/248-501/000-012
	Art-Nr.: 248-501/000-017 Mini-WSB-Beschriftungskarte; als Karte; nicht dehnbar; unbedruckt; aufrastbar; hellgrün	www.wago.com/248-501/000-017

	Art-Nr.: 248-501/000-023 Mini-WSB-Beschriftungskarte; als Karte; nicht dehnbar; unbedruckt; aufrastbar; grün	www.wago.com/248-501/000-023
	Art-Nr.: 248-501/000-024 Mini-WSB-Beschriftungskarte; als Karte; nicht dehnbar; unbedruckt; aufrastbar; violett	www.wago.com/248-501/000-024
	Art-Nr.: 793-501 WMB-Beschriftungskarte; als Karte; nicht dehnbar; unbedruckt; aufrastbar; weiß	www.wago.com/793-501
	Art-Nr.: 793-501/000-002 WMB-Beschriftungskarte; als Karte; nicht dehnbar; unbedruckt; aufrastbar; weiß	www.wago.com/793-501/000-002
	Art-Nr.: 793-501/000-005 WMB-Beschriftungskarte; als Karte; nicht dehnbar; unbedruckt; aufrastbar; rot	www.wago.com/793-501/000-005
	Art-Nr.: 793-501/000-006 WMB-Beschriftungskarte; als Karte; nicht dehnbar; unbedruckt; aufrastbar; blau	www.wago.com/793-501/000-006
	Art-Nr.: 793-501/000-007 WMB-Beschriftungskarte; als Karte; nicht dehnbar; unbedruckt; aufrastbar; grau	www.wago.com/793-501/000-007
	Art-Nr.: 793-501/000-012 WMB-Beschriftungskarte; als Karte; nicht dehnbar; unbedruckt; aufrastbar; orange	www.wago.com/793-501/000-012
	Art-Nr.: 793-501/000-017 WMB-Beschriftungskarte; als Karte; nicht dehnbar; unbedruckt; aufrastbar; hellgrün	www.wago.com/793-501/000-017
	Art-Nr.: 793-501/000-023 WMB-Beschriftungskarte; als Karte; nicht dehnbar; unbedruckt; aufrastbar; grün	www.wago.com/793-501/000-023
	Art-Nr.: 793-501/000-024 WMB-Beschriftungskarte; als Karte; nicht dehnbar; unbedruckt; aufrastbar; violett	www.wago.com/793-501/000-024
	Art-Nr.: 793-5501 WMB-Beschriftungskarte; als Karte; für Klemmenbreite 5 - 17,5 mm; dehnbar 5 - 5,2 mm; unbedruckt; aufrastbar; weiß	www.wago.com/793-5501
	Art-Nr.: 793-5501/000-002 WMB-Beschriftungskarte; als Karte; für Klemmenbreite 5 - 17,5 mm; dehnbar 5 - 5,2 mm; unbedruckt; aufrastbar; gelb	www.wago.com/793-5501/000-002
	Art-Nr.: 793-5501/000-005 WMB-Beschriftungskarte; als Karte; dehnbar 5 - 5,2 mm; unbedruckt; aufrastbar; rot	www.wago.com/793-5501/000-005
	Art-Nr.: 793-5501/000-006 WMB-Beschriftungskarte; als Karte; dehnbar 5 - 5,2 mm; unbedruckt; aufrastbar; blau	www.wago.com/793-5501/000-006



Art-Nr.: 793-5501/000-007
WMB-Beschriftungskarte; als Karte; dehnbar 5 - 5,2 mm; unbedruckt; aufrastbar; grau

www.wago.com/793-5501/000-007



Art-Nr.: 793-5501/000-012
WMB-Beschriftungskarte; als Karte; dehnbar 5 - 5,2 mm; unbedruckt; aufrastbar; orange

www.wago.com/793-5501/000-012



Art-Nr.: 793-5501/000-017
WMB-Beschriftungskarte; als Karte; dehnbar 5 - 5,2 mm; unbedruckt; aufrastbar; hellgrün

www.wago.com/793-5501/000-017



Art-Nr.: 793-5501/000-023
WMB-Beschriftungskarte; als Karte; dehnbar 5 - 5,2 mm; unbedruckt; aufrastbar; grün

www.wago.com/793-5501/000-023



Art-Nr.: 793-5501/000-024
WMB-Beschriftungskarte; als Karte; dehnbar 5 - 5,2 mm; unbedruckt; aufrastbar; violett

www.wago.com/793-5501/000-024

Brücker

Art-Nr.: 2006-433
Kammbrücker; isoliert; von 1 auf 3; Nennstrom 41 A; lichtgrau

www.wago.com/2006-433

Art-Nr.: 2006-435
Kammbrücker; isoliert; von 1 auf 5; Nennstrom 41 A; lichtgrau

www.wago.com/2006-435

Art-Nr.: 210-103
Drahtkettenbrücke; isoliert; 50 Anschlüsse; schwarz

www.wago.com/210-103

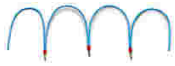

Art-Nr.: 210-123
Drahtkettenbrücke; isoliert; 50 Anschlüsse

www.wago.com/210-123

Downloads

Dokumentation

Ausschreibungstext

2006-8671	docx	Download
	15,8 kB	

Weitere Informationen

Technische Erläuterungen	03-Apr-2019	pdf	Download
		2,1 MB	

CAD/CAE-Daten

CAD Daten

2D/3D Modelle 2006-8671	URL	Download
-------------------------	-----	----------

EPLAN

EPLAN Data Portal 2006-8671	Download
-----------------------------	----------



WSCAD

WSCAD Universe 2006-8671

[Download](#)

Handhabungshinweise

Produktfamilie

TOPJOB® S

TOPJOB® S: Das breite und flexible Produktprogramm an Reihenklemmen bietet in diversen Industrieanwendungen und in der modernen Gebäudeinstallation mehr als nur eine sichere elektrische Verbindung.

[Alle Produkte der Familie anzeigen](#)

Änderungen vorbehalten.

WAGO Kontakttechnik GmbH & Co. KG
Hansastr. 27
32423 Minden
Telefon: +49571 887-0
E-Mail: info.de@wago.com | Web: www.wago.com

Haben Sie Fragen zu unseren Produkten?
Wir stehen Ihnen telefonisch unter +49 (571) 887-44222 gern zur
Verfügung.