

PCE data sheet

article#	6115-6k
article description	CEE-switched interlocked socket compact 16A 5p 6h IP44/IP54 knock-out
description long	CEE-switched interlocked socket compact 16A5p 6h IP44/IP54 knock-out housing material: PA6 + PC/ABS rated current: 16A number of poles: 5 (3P+N+PE) clock-position: 6h rated voltage/frequency: 200/346V~ - 240/415V~ / 50+60Hz contacts: brass nickel plated connection technology: screw terminals wall mounting housing with knock-out, mechanical interlock switch: ON/OFF PCE-Merz ML0; EN 60947-3; AC22A, 10kA IP protection class: IP44/IP54
GTIN (EAN)	9003399421846
country of origin	AT
customs number	85366990
net weight	0.659 kg
packaging quantity	1

ETIM 7.0	EC001324
IEC-amperage	16 A
Number of poles	5
Voltage acc. EN 60309-2	400 V (50+60 Hz) red
Clock hour position	6 h
Identification colour	Red
Degree of protection (IP)	IP54
Switch	Mechanical locking
Material housing	Plastic
Model	Base unit and cover
Contact material	CuZn
Surface finish contacts	Nickel-plated

wire flexible	1,5-2,5 mm ²
wire solid	1,5-4 mm ²

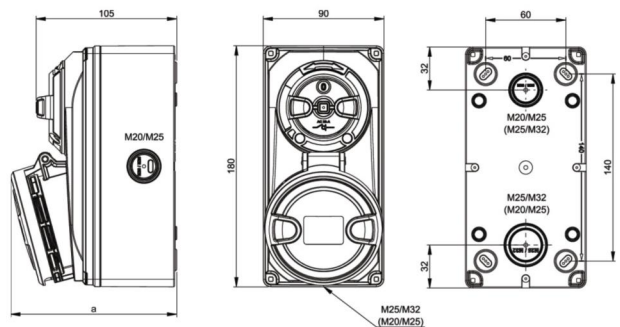

www.manufacturer-safety.info