

PCE data sheet

article#	917-6v
article description	CEE-wall mounted socket 16A 7p 6h IP44/IP54
description long	CEE-wall mounted socket 16A 7p 6h IP44/IP54 housing material: PA6 rated current: 16A number of poles: 7 (6P+PE) clock-position: 6h rated voltage/frequency: 380-415V~ / 50+60Hz contacts: brass nickel plated connection technology: screw terminals IP protection class: IP44/IP54
GTIN (EAN)	9003399088698
country of origin	AT
customs number	85366990
net weight	0.351 kg
packaging quantity	5

ETIM 7.0	EC001321
IEC-amperage	16 A
Number of poles	7
Voltage acc. EN 60309-2	400 V (50+60 Hz) red
Clock hour position	6 h
Identification colour	Red
Degree of protection (IP)	IP54
Connection system	Schraubklemme
Cable entry	Verschraubung
Material	Plastic
Type of fastening	External mounting
Insulated mounting	True

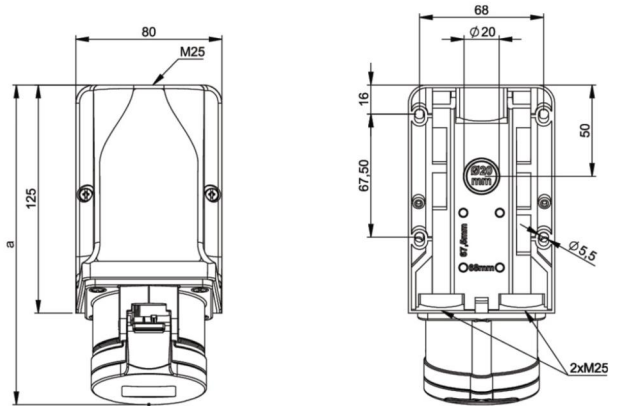

b=Höhe/height
Neigung/angle=15°



www.manufacturer-safety.info